

Integrated use of weather, climate, water quantity and quality expertise in hydrological services in Finland

Bertel Vehviläinen, Kimmo Söderholm, Ari Koistinen, Harri Myllyniemi, Markus Huttunen, Noora Veijalainen, Juho Jakkila, Marie Korppoo, Inese Huttunen, Vesa Kolhinen, Paula Havu, Juha Markkula, Miia Smolander, Jari Uusikivi, Mikko Sane, Kalle Sippel, Panu Juntunen, Vanamo Piirainen

Finnish Environment Institute SYKE

Integrated use of weather, climate, water quantity and quality expertise in hydrological services in Finland

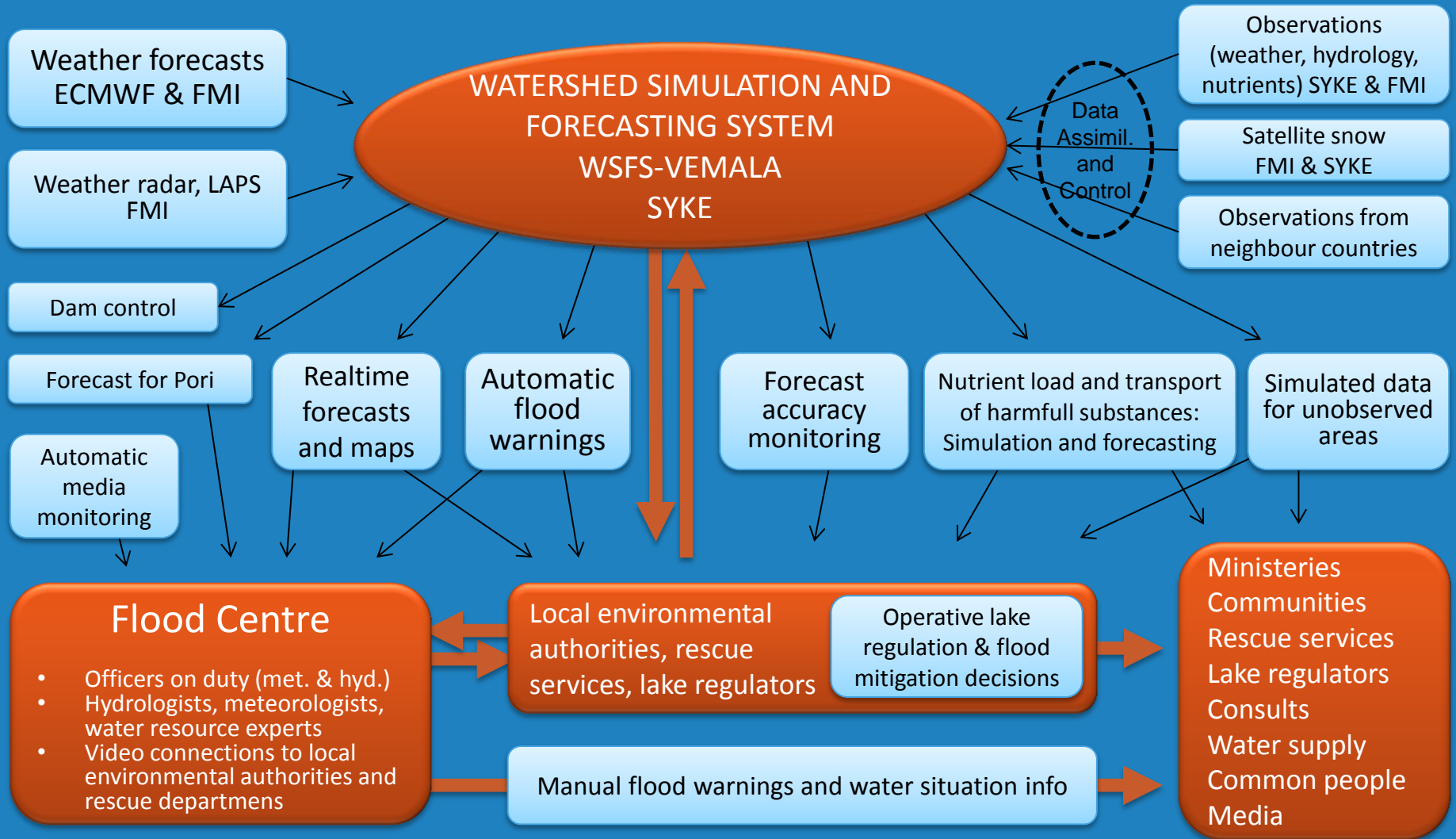

R
&
D

Climate change

1-hour timestep model

Process models: [water quality](#), [lakes](#), [soil moisture](#), [ice](#), [frost & snow](#), [corrected precipitation](#), [evaporation](#)

Adaptive outflow calculation

Tailored modelling solutions

International examples

Water balance for mines

Planning & design floods

Hydrological cycle

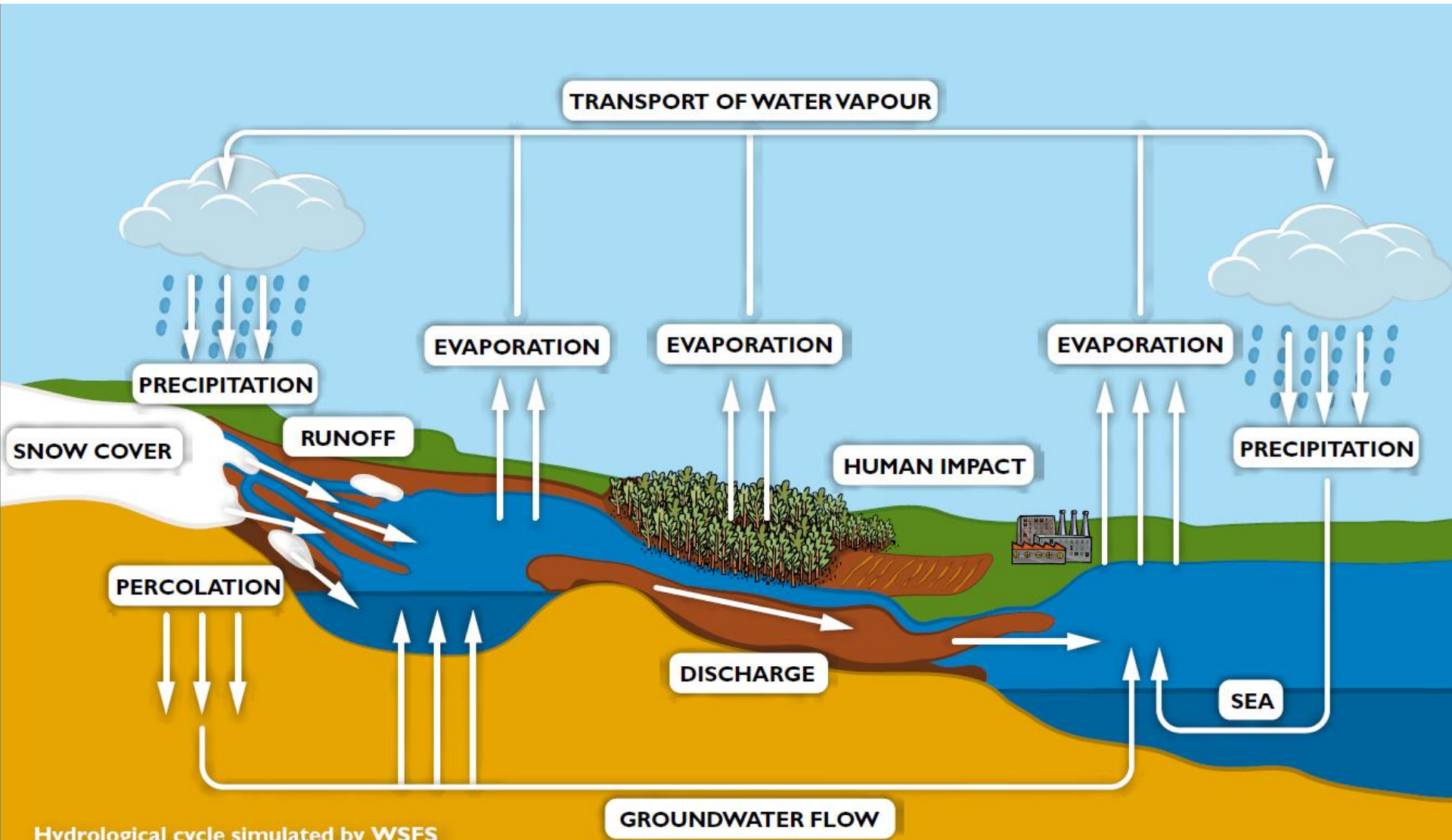

WSFS model concept

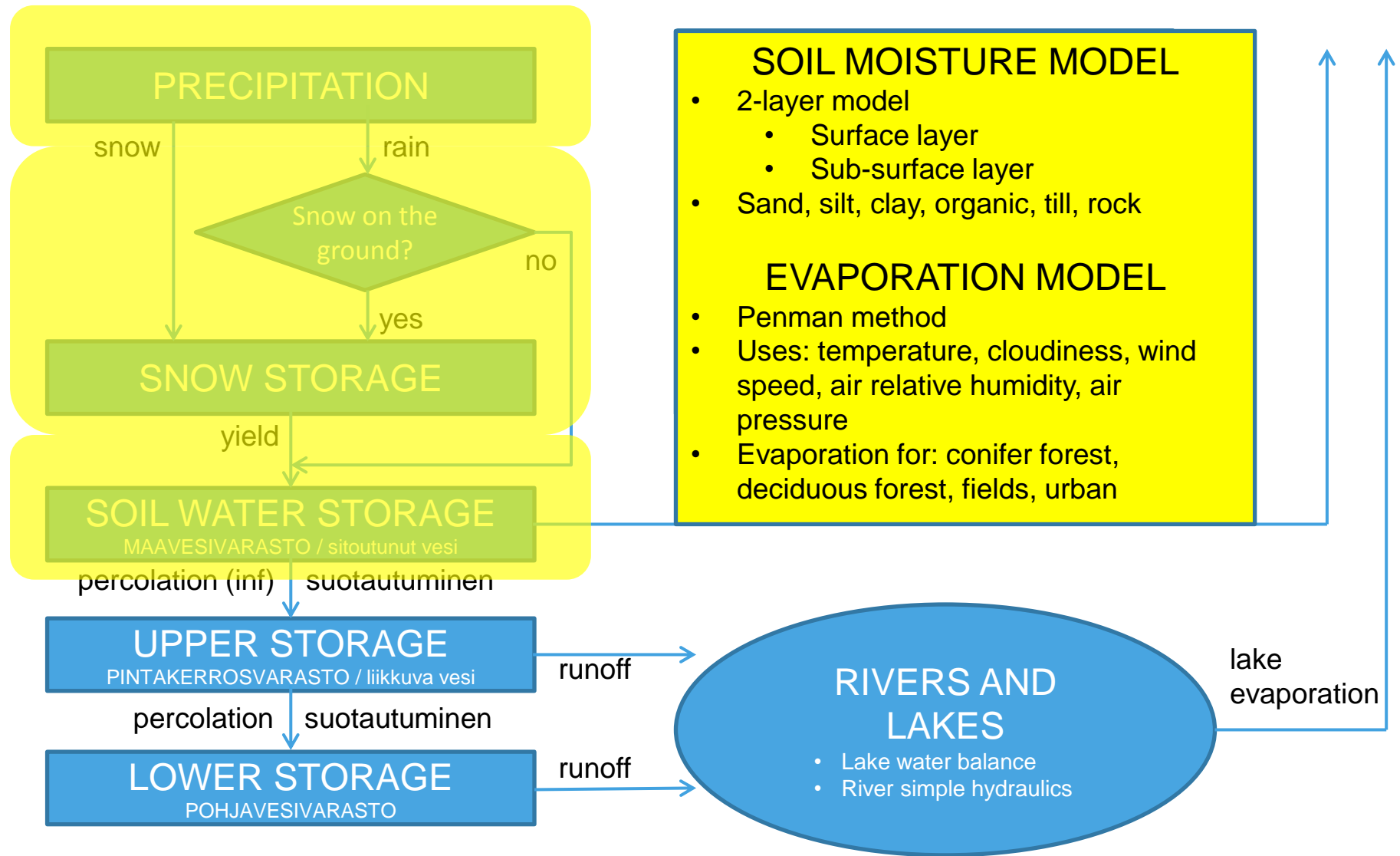

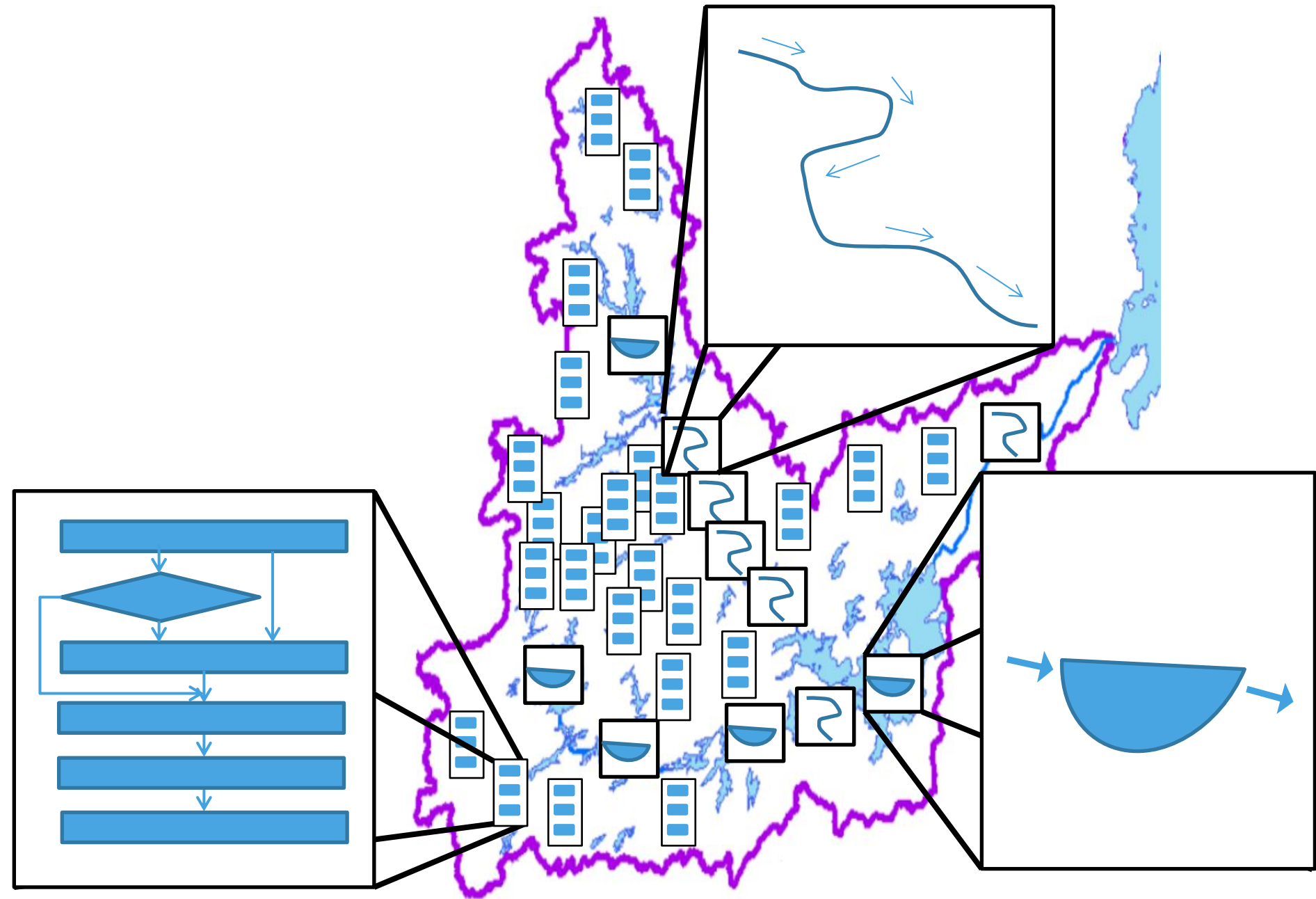

User and operator interface (mobile)

<http://wsfs.vyh.fi>

suomeksi
 Front page
 Forecasts
 Weather forecast
 Observations
 Regulation schedules
 Regulation simulation
 Regulation optimizatio
 Settings of the model
 Simulated data
 1962-
 Numeric forecasts
 Hydrological maps
 Water resources for Finland

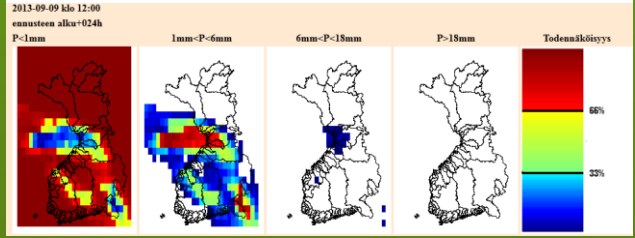
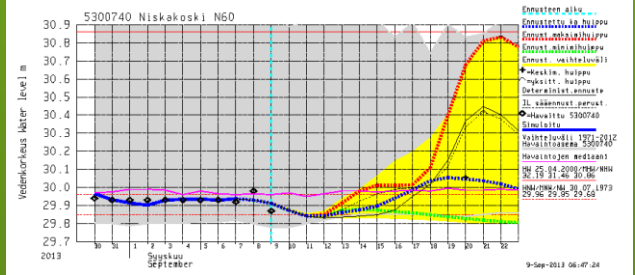

Full system control

All products and system information

Water situation description

HYDROLOGICAL MODELING AND FORECASTING SYSTEM

Automatic forecasts and maps

Public www

River discharges are low throughout the country
 River discharges have decreased during sunny and dry period. Only light rains are forecasted so discharges will stay low...

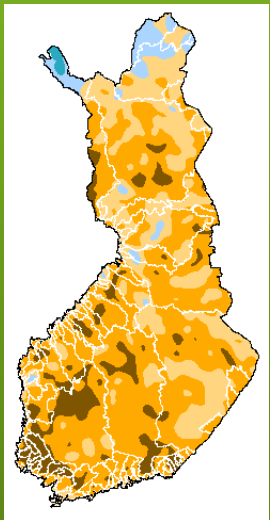

Presentation video (in Youtube https://www.youtube.com/watch?feature=player_embedded&v=aWI3UamQXpY):

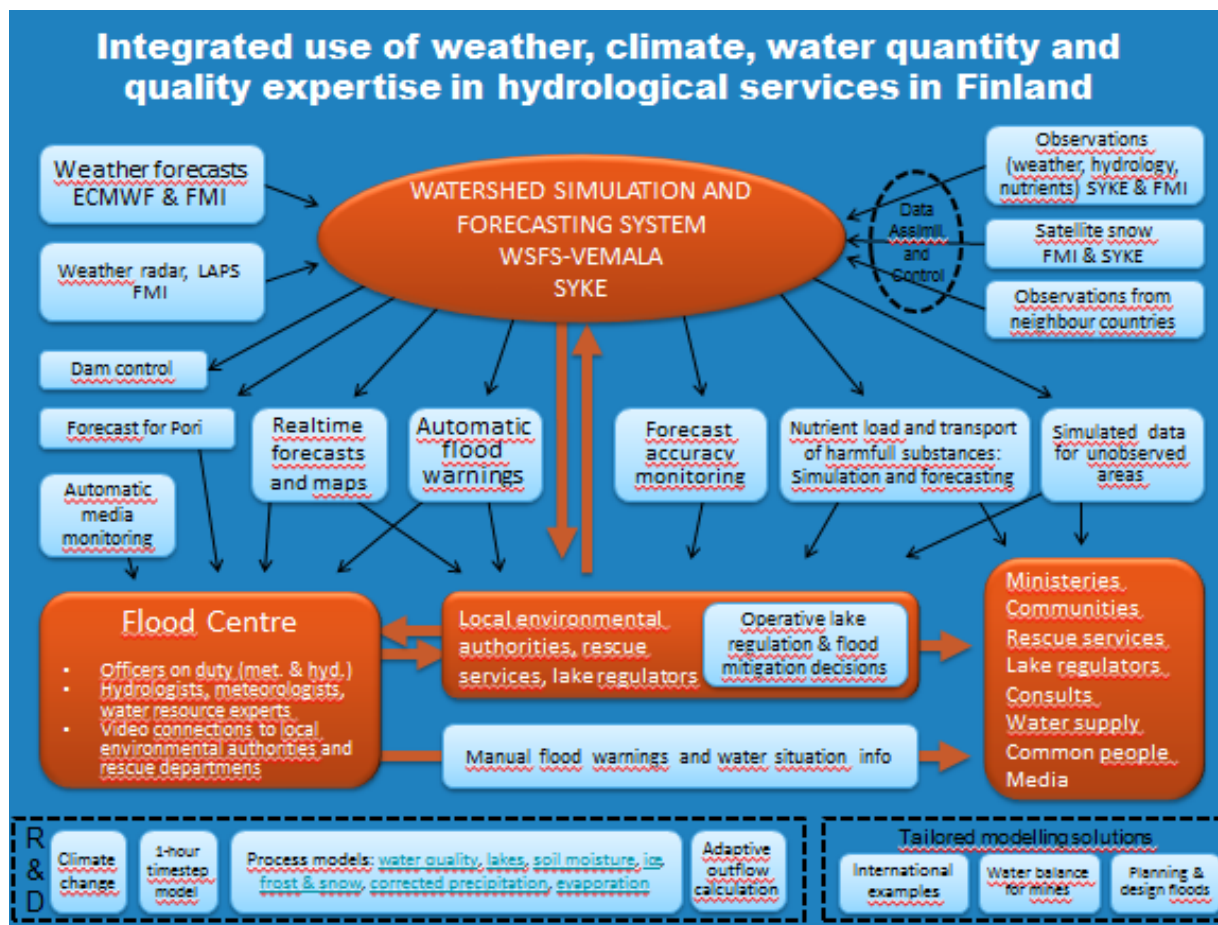

Publications

- Vehviläinen, B. 1994. The watershed simulation and forecasting system in the National Board of Waters and Environment. Publications of the Water and Environment Research Institute. National Board of Waters and the Environment, Finland. No. 17.
- Vehviläinen, B. 1992. Snow cover models in operational watershed forecasting. Publications of Water and Environment Research Institute 11. Helsinki. 112 p.
- A national scale nutrient loading model for Finnish watersheds - VEMALA / Inese Huttunen, Markus Huttunen, Vanamo Piirainen, Marie Korppoo, Ahti Lepistö, Antti Räike, Sirkka Tattari, Bertel Vehviläinen Environmental modeling and assessment, ISSN: 1573-2967
- Vehviläinen, B., Huttunen, M. and Huttunen, I. 2005. Hydrological forecasting and real time monitoring in Finland: The watershed simulation and forecasting system (WSFS). In Innovation, Advances and Implementation of Flood Forecasting Technology, conference papers, Tromso, Norway, 17 to 19 October 2005. ISBN Book 1-898485-13-5.

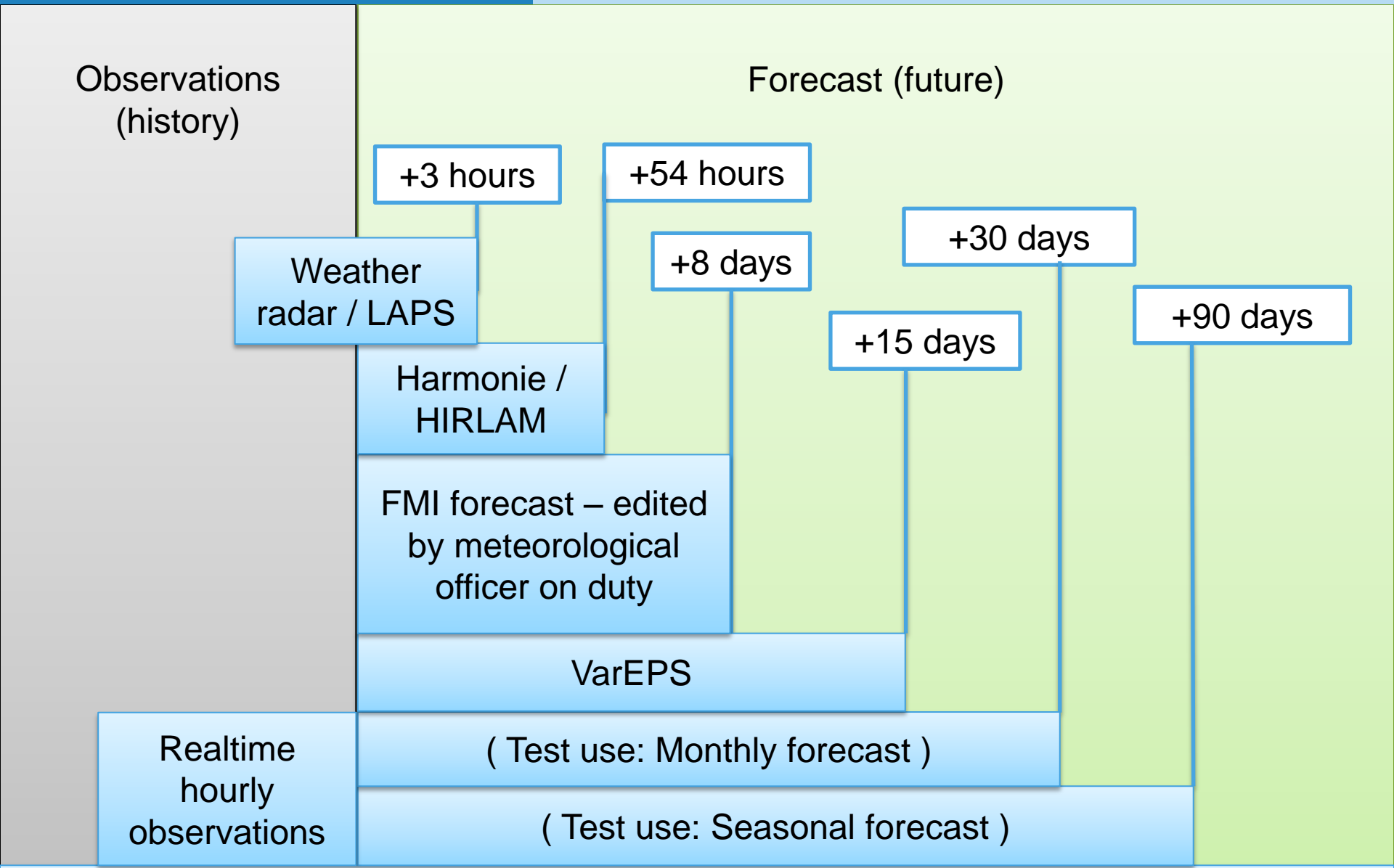

Observations
(history)

Forecast (future)

+3 hours

+54 hours

Weather
radar / LAPS

+8 days

+30 days

Harmonie /
HIRLAM

+15 days

+90 days

FMI forecast – edited
by meteorological
officer on duty

VarEPS

Realtime
hourly
observations

(Test use: Monthly forecast)

(Test use: Seasonal forecast)

Climatology, historical observations

Hydrological expertise in Finland

Weather forecasts (2/8)

Name	Type	Forecast length	Delivery	Time-step	Resolution	Variables
FMI edited forecast	Determ.	6 days	4 times a day	1 h		<ul style="list-style-type: none"> • air temp. • prec.
Harmonie	Determ. (possibly ensemble in future?)	54 h	4 times a day	1 h	2.5 km	<ul style="list-style-type: none"> • liquid prec. • solid prec. • air temp. • wind speed • wind dir. • radiation • humidity
ECMWF EPS	Ensemble	15 days	Twice a day	6 h	0.5°	<ul style="list-style-type: none"> • prec. • air temp. • ground temp. • cloudiness • wind speed • wind dir • dew point • radiation • Evaporation
Monthly	Ensemble	30 days	Once a week	6 h	1.5°	<ul style="list-style-type: none"> • prec. • air temp.
Seasonal	Ensemble	90 days	Once a month	6 h	1.5°	<ul style="list-style-type: none"> • prec. • air temp.

High resolution FMI forecast – edited by meteorologist on duty

- Based on high resolution weather forecast models
- Edited by meteorologist on duty
- Combines best knowledge of phenomena with best observations and forecast models available

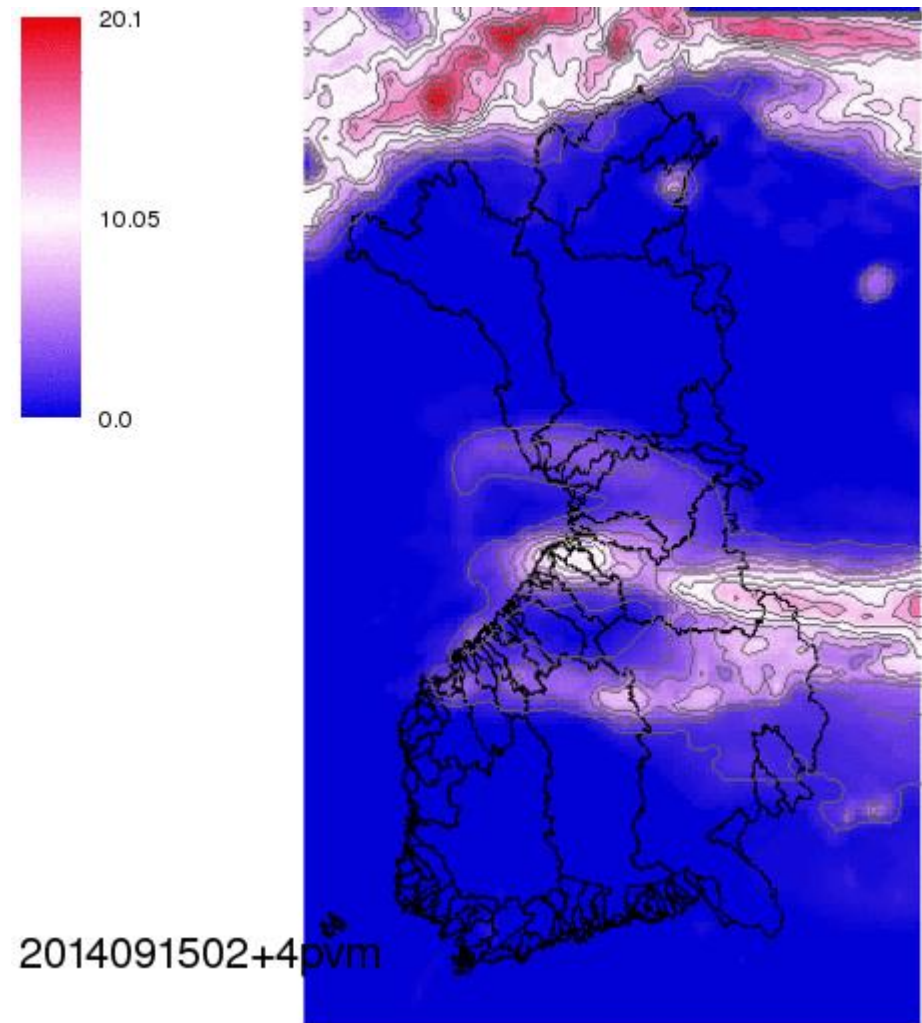

Short range weather forecasts

- Hirlam 54h
 - optional
- Edited 8 days
 - Ensemble T moved towards edited
- Nowcasting 3h
 - Precipitation from radar

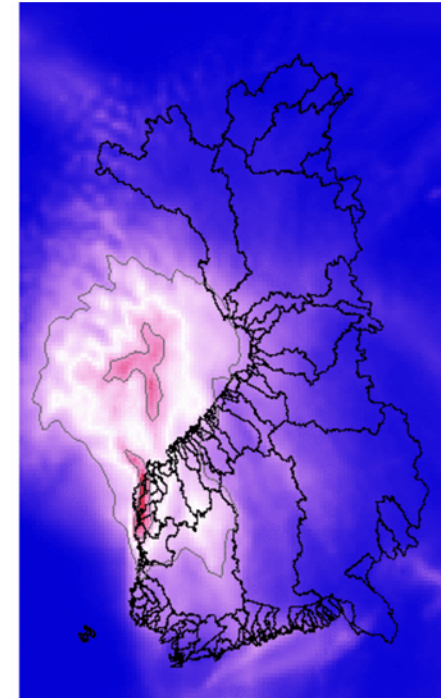
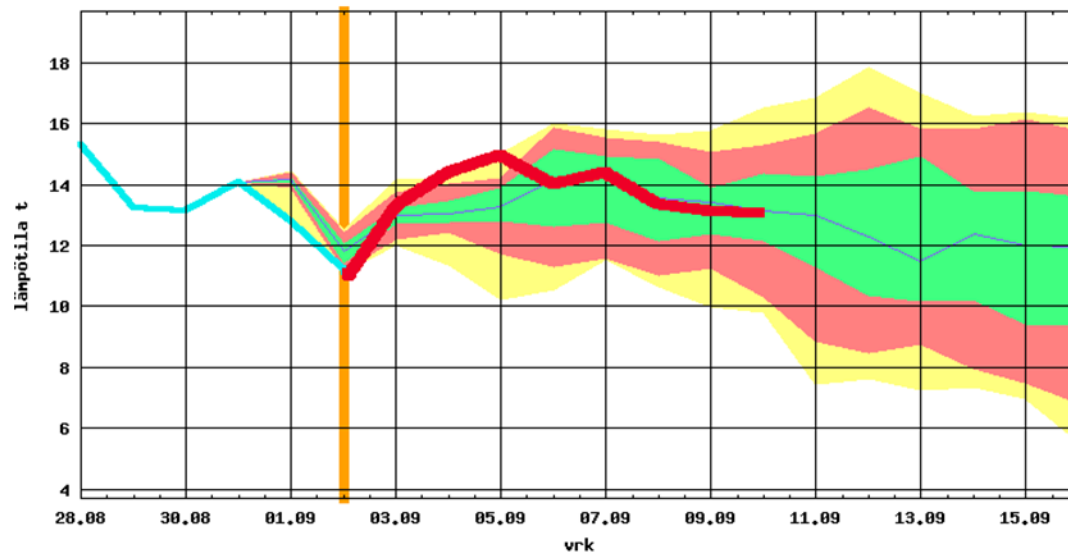

- The input of the operational model is
 - Observed weather (in history)
 - **ECMWF 15 days VarEPS**, 50 members. The first days are corrected against FMI deterministic forecast.
 - Climatology of the last 50 years: every member of VarEPS is continued by data from a certain historical year
 - Result: probabilistic hydrological forecast for 1 year.
- Since 2007 experimental forecasts have been made using **monthly and seasonal EPS**:
 - ECMWF monthly EPS, produced weekly, time span 30 days (two weeks after VarEPS).
 - ECMWF seasonal EPS, produced monthly, time span 90 days (30-60 days after the monthly EPS).
 - The length of the period based on various weather forecasts is 60-90 days, and climatology is used only after that.
 - **During very warm winters 2007-08 and 2008-09 the hydrological forecasts made using monthly/seasonal EPS were clearly better, but overall performance cannot be said to be better than climatology.**

Mean forecast goodness of fit values for lake inflow 30, 60 and 90 days ahead

- Comparing inflow forecasts of 2013 shows that using operative weather forecast gave better results than using experimental use monthly and seasonal EPS weather forecasts

30 days inflow forecast accuracy

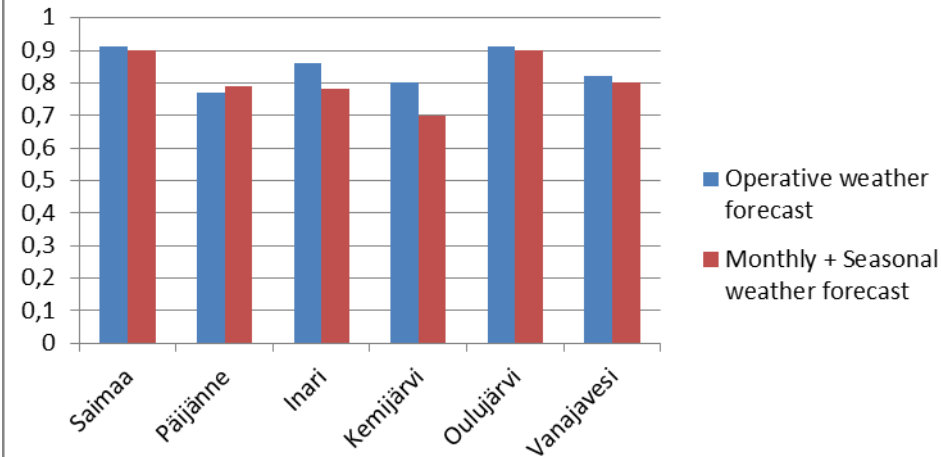

60 days inflow forecast accuracy

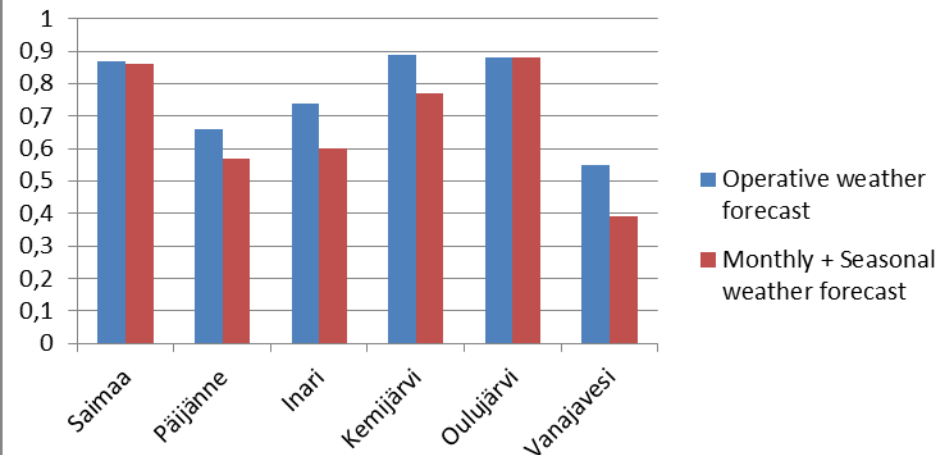

90 days inflow forecast accuracy

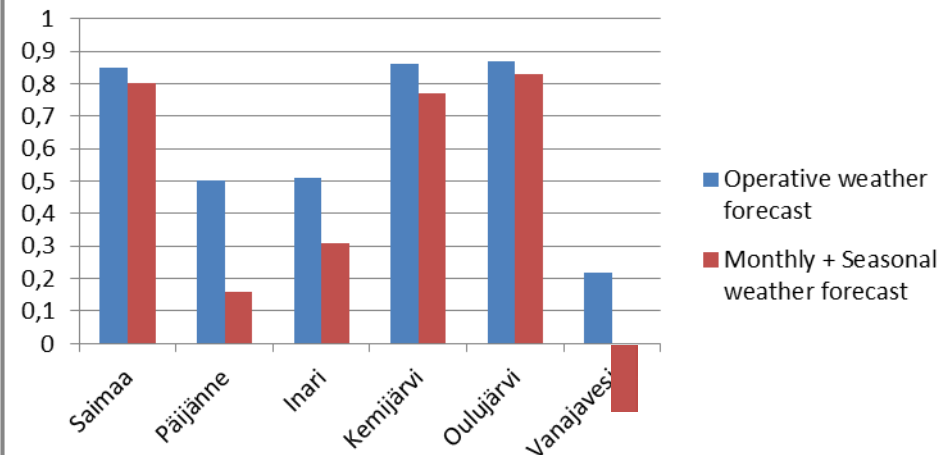

Temperature, lake Saimaa: right now there is not big difference between monthly/seasonal EPS (the first picture) and climatology

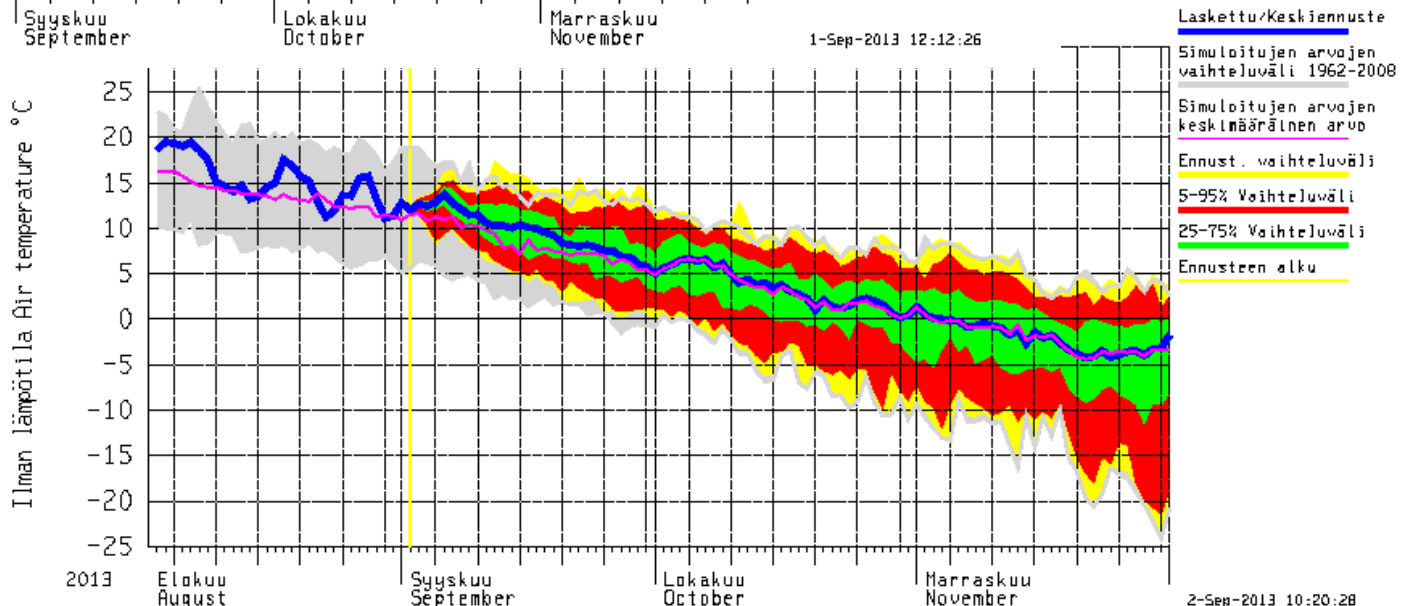
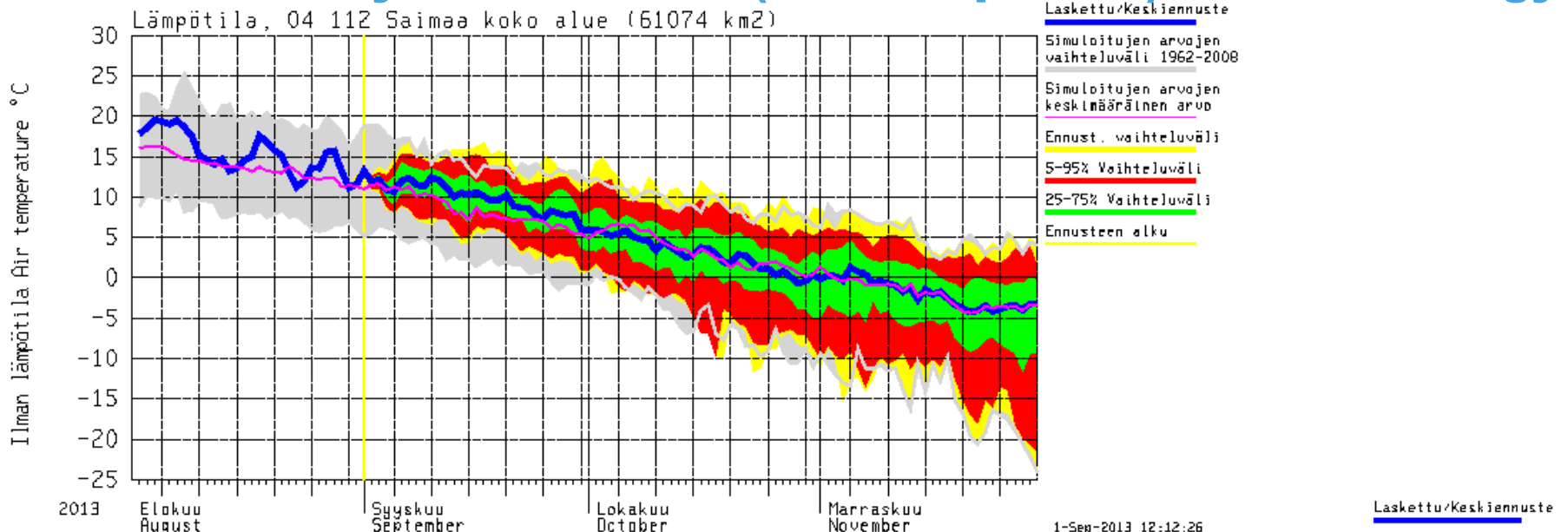

Precipitation, lake Saimaa. First monthly/seasonal EPS, then climatology. (No significant difference in forecasted water level.)

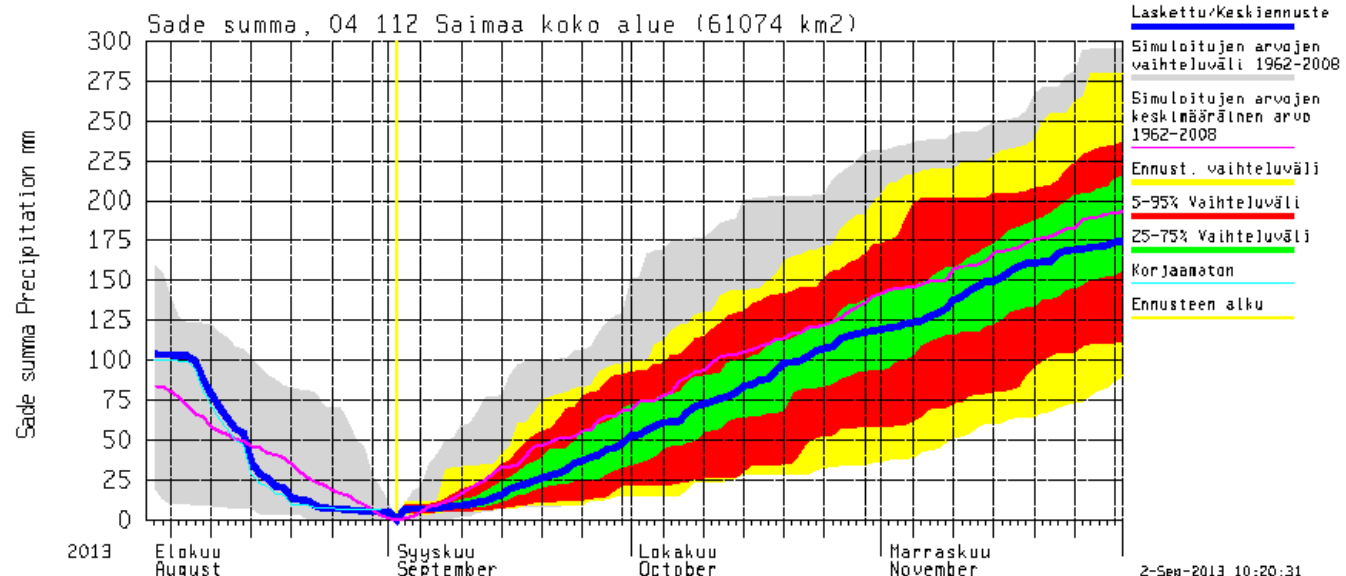
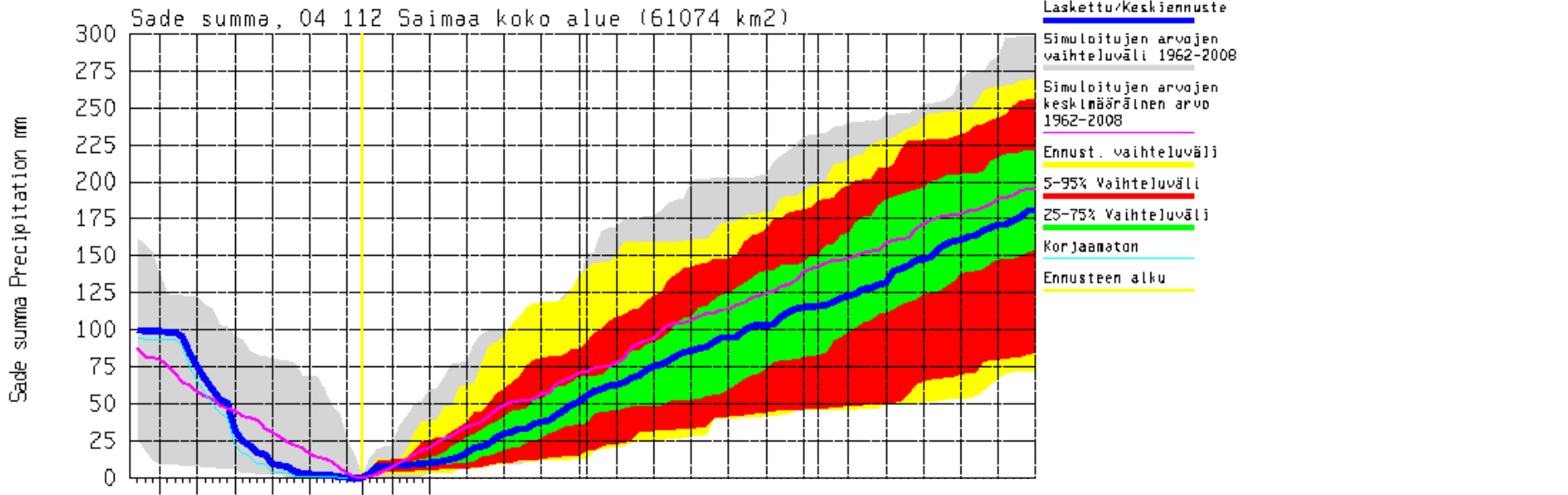

Weather radar and LAPS in WSFS

Weather radar

- Hourly radar data in 2x2km grid
- Used for 2 days in model
- Underestimates large rainfalls
 - Corrected manually against rain gauges

Radar nowcasting

- 3hrs in Southern Finland
- Ensemble of 50 members

LAPS

- Combines information from weather radar, automatic real-time rain gauges, road weather measurements, ...
- Will probably be used in WSFS as a weather radar replacement in near future

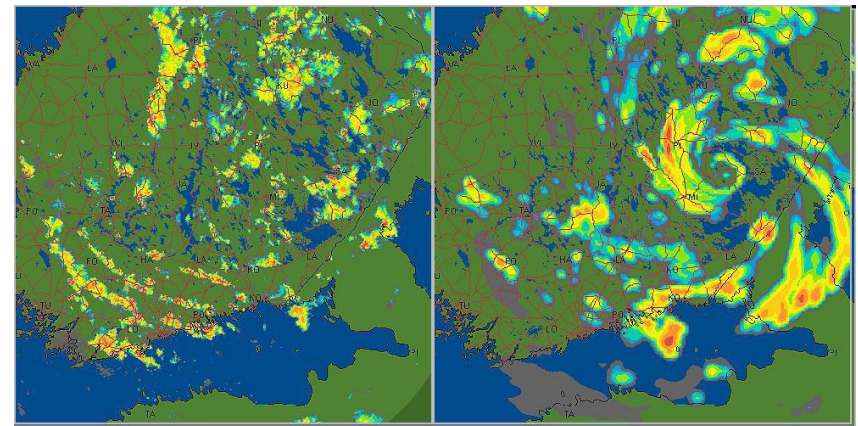
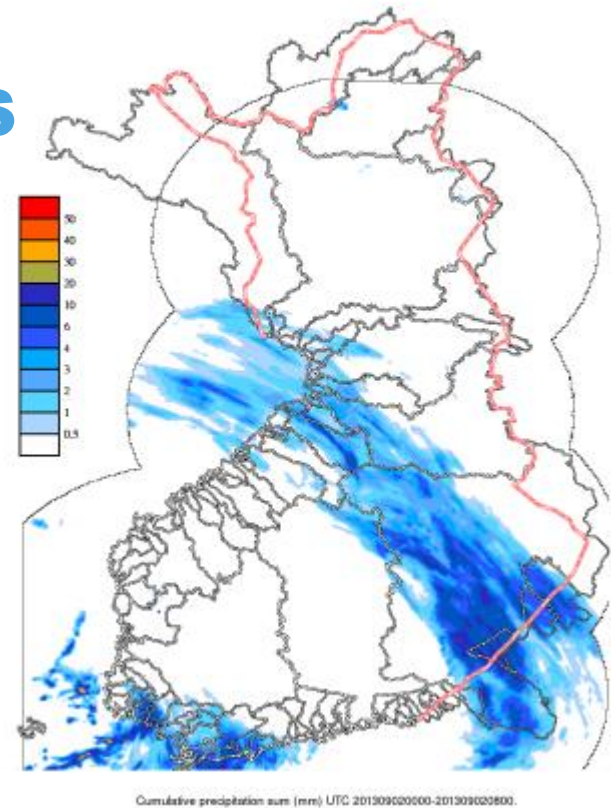

Observation networks

- Automatic realtime precipitation 1-hour measurements from 100 stations
- 380 discharge stations
 - 220 with daily measurements
 - 160 external stations with usually daily measurements
- 660 water level stations
 - 400 with daily measurements
 - 260 external stations with usually daily measurements
- Snow courses
 - 140 montly measurements
- Water quality measurements

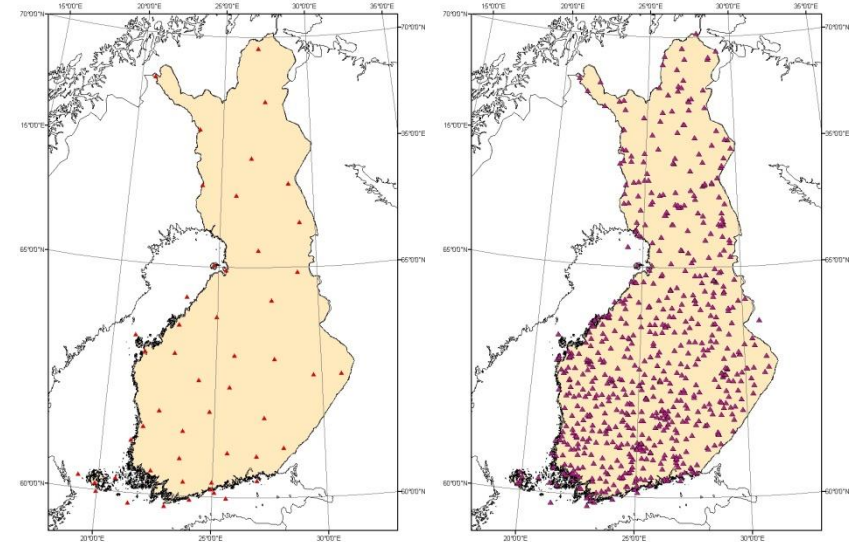

Synoptic weather stations, 50
daily measurements

Other weather stations, 200
daily measurements

Measuring the snow water equivalent

- Snow water equivalent is measured by snow course measurements
 - About 140 snow courses in Finland (less than what is shown at the map)
- Areal snow water equivalents are calculated for approximately 110 areas
- Snow courses are 2-4 km long routes through various terrains
 - 80 depth measurements
 - 8 manual weightings
- Measurements are made once or twice a month

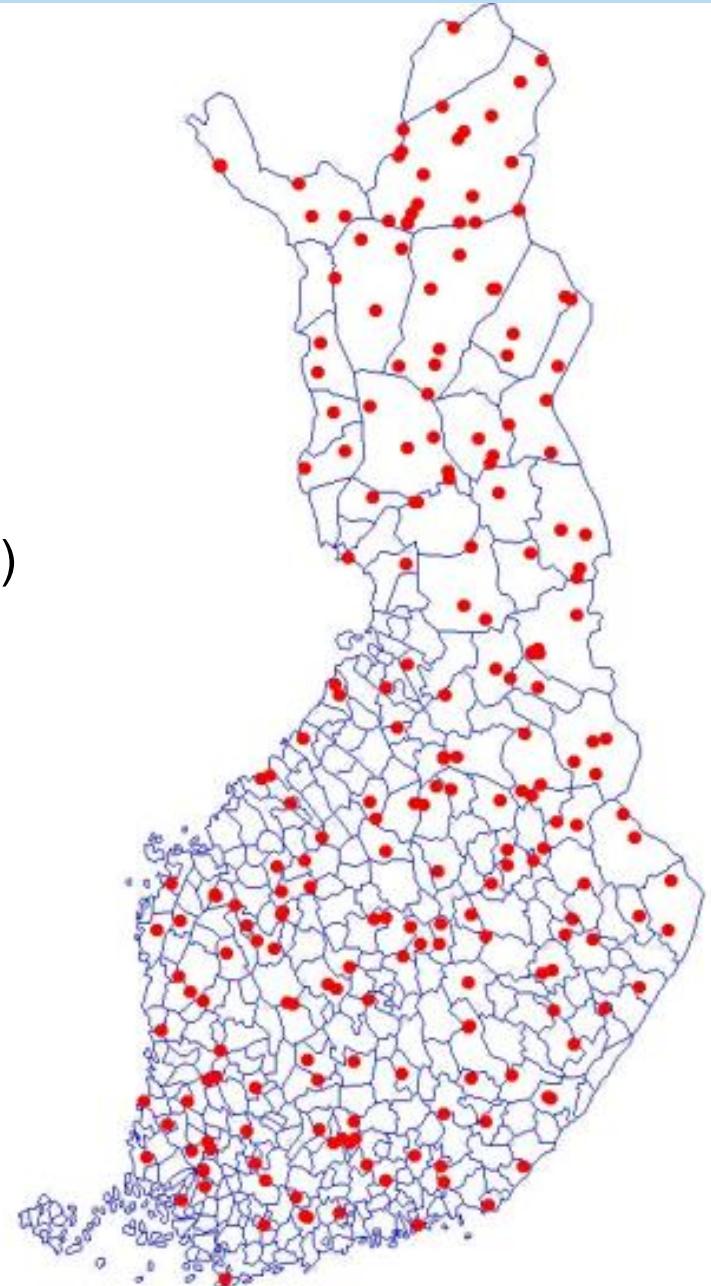

Measuring the snow water equivalent



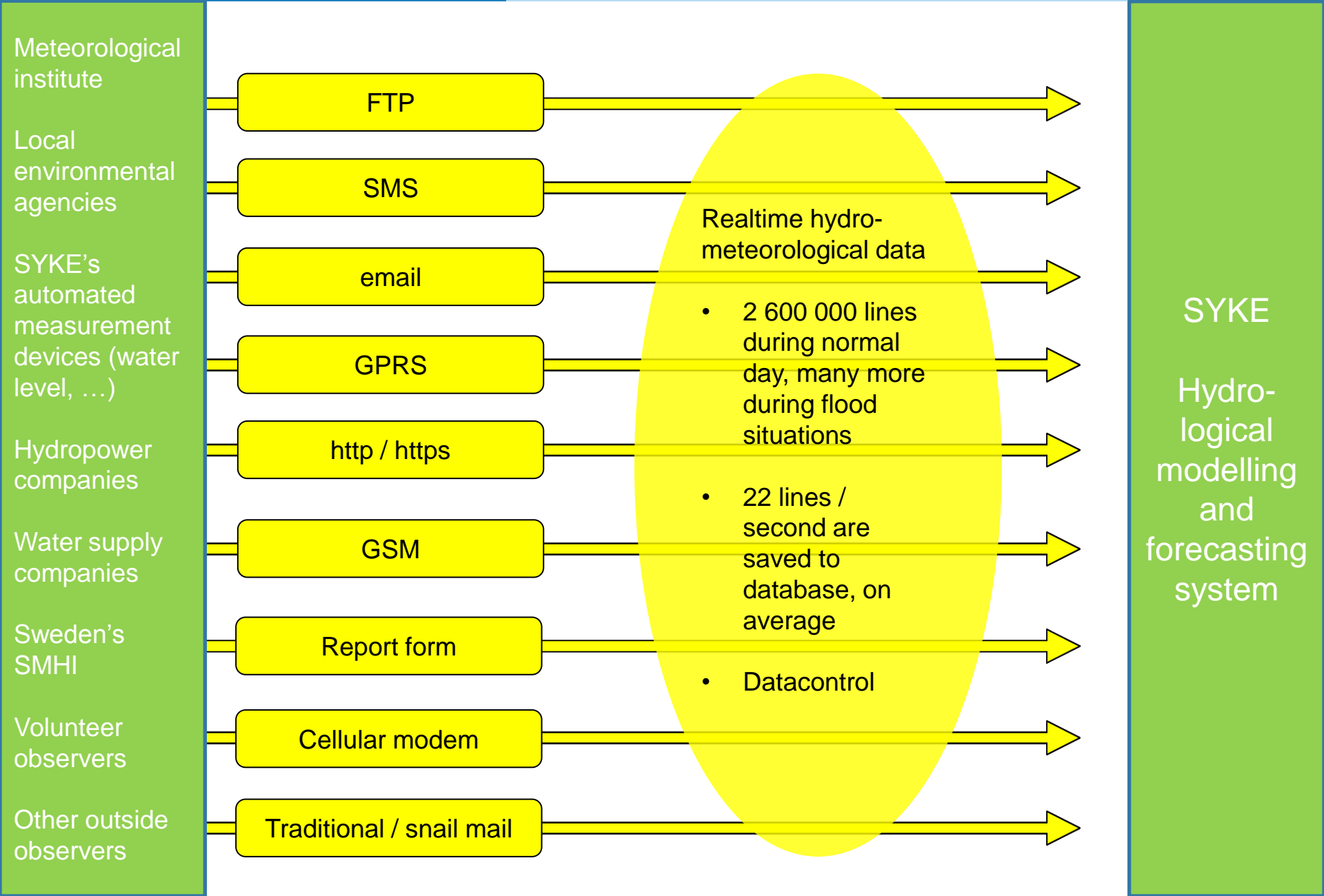

Meteorological institute

FTP

Local environmental agencies

SMS

SYKE's automated measurement devices (water level, ...)

email

GPRS

Hydropower companies

http / https

Water supply companies

GSM

Sweden's SMHI

Report form

Volunteer observers

Cellular modem

Other outside observers

Traditional / snail mail

Manual measurements

- Manual river discharge measurement
- Manual precipitation observations
- Snow line measurements

Automatic observations

- Automatic river water level observation
- Automatic precipitation observations
- Snow depth from automatic stations

Derived results / algorithmic data

- Weather radar precipitation
- Wind corrected precipitation observations
- "Near-by-complemented" precipitation observations
- Satellite value for snow water equivalent
- Interpolated snow water equivalent

Simulations

- Areal precipitation
- Runoff, discharge, water level, soil moisture, ...
- Areal precipitation corrected to match water balance
- Snow water equivalent, snow depth, ground frost depth
- Ice thickness

Observed data

Calculated data

Data assimilation algorithm

- To estimate the state of the hydrological system today
- Assimilation observations of:
 - discharge and water levels (over 400 stations)
 - snow water equivalent (over 150 stations)
 - SCA satellite data
 - flood cover area (experimental)
- Corrects inputs of the model (daily precipitation and temperature)
- Simulation is corrected to agree with observations on a 1-2 year long period backward

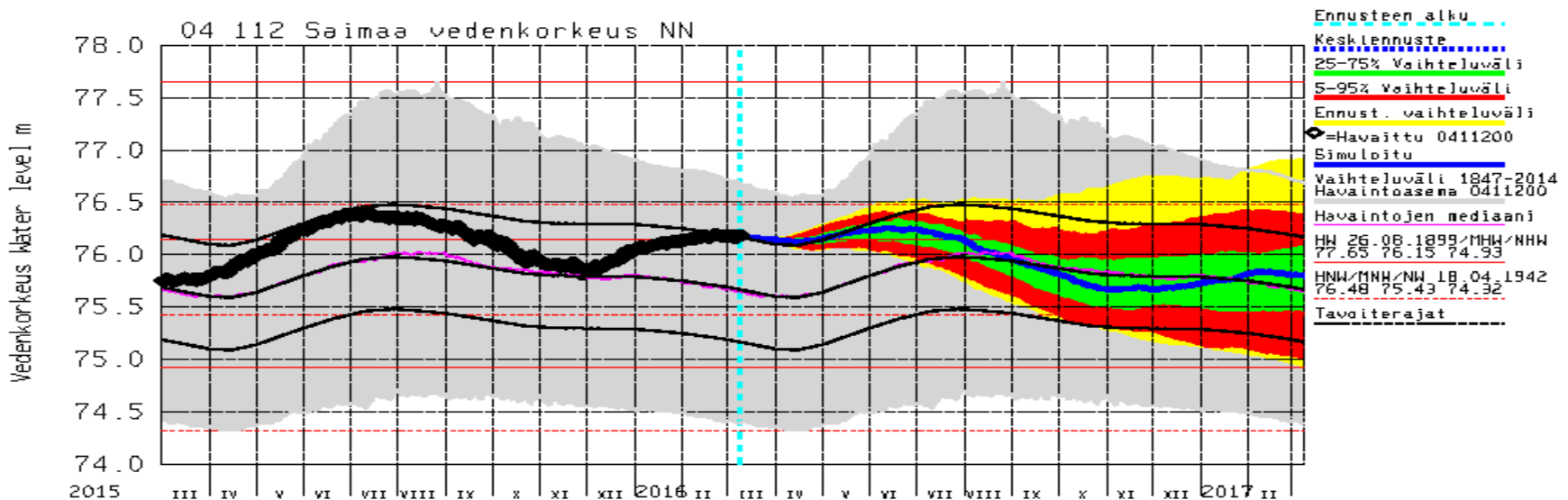

Example: forecast gone wrong when data is not filtered

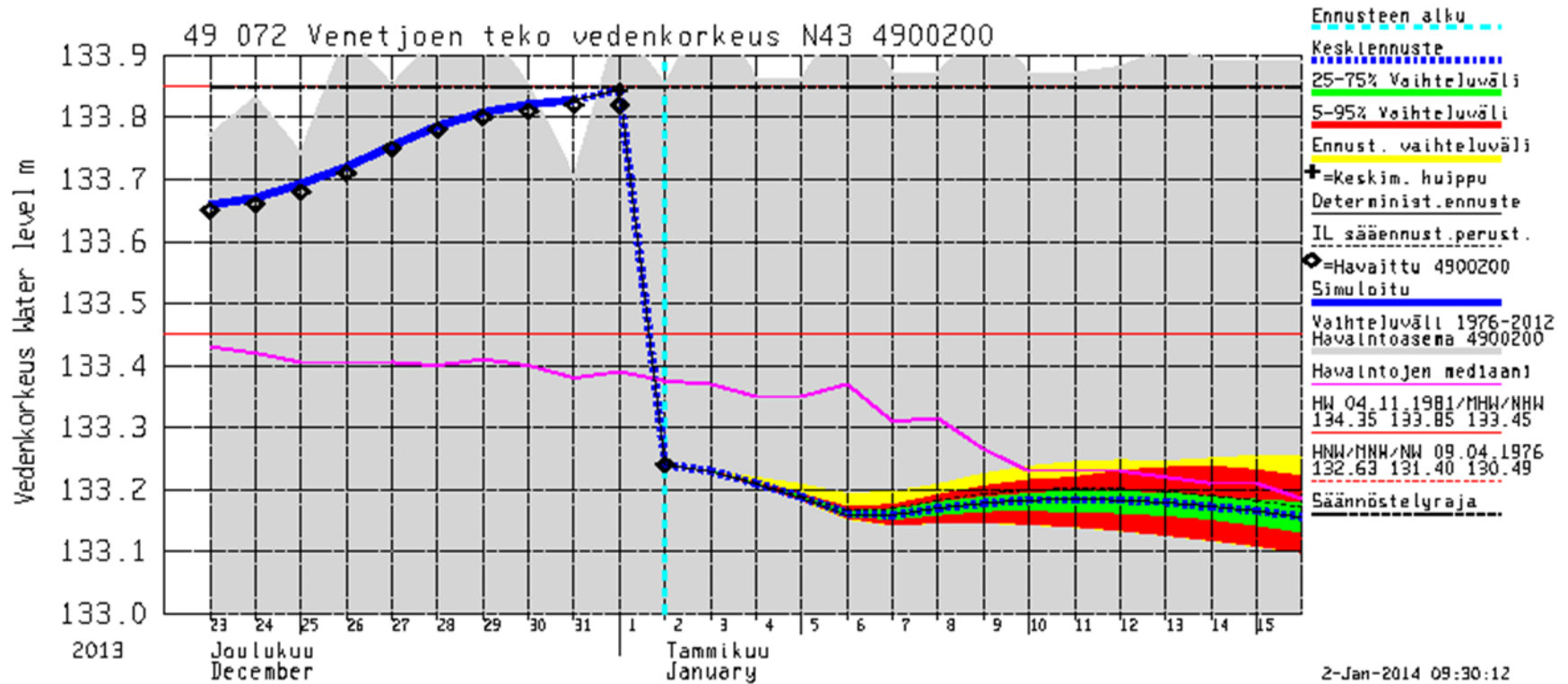

Example: forecast gone wrong when data is not filtered

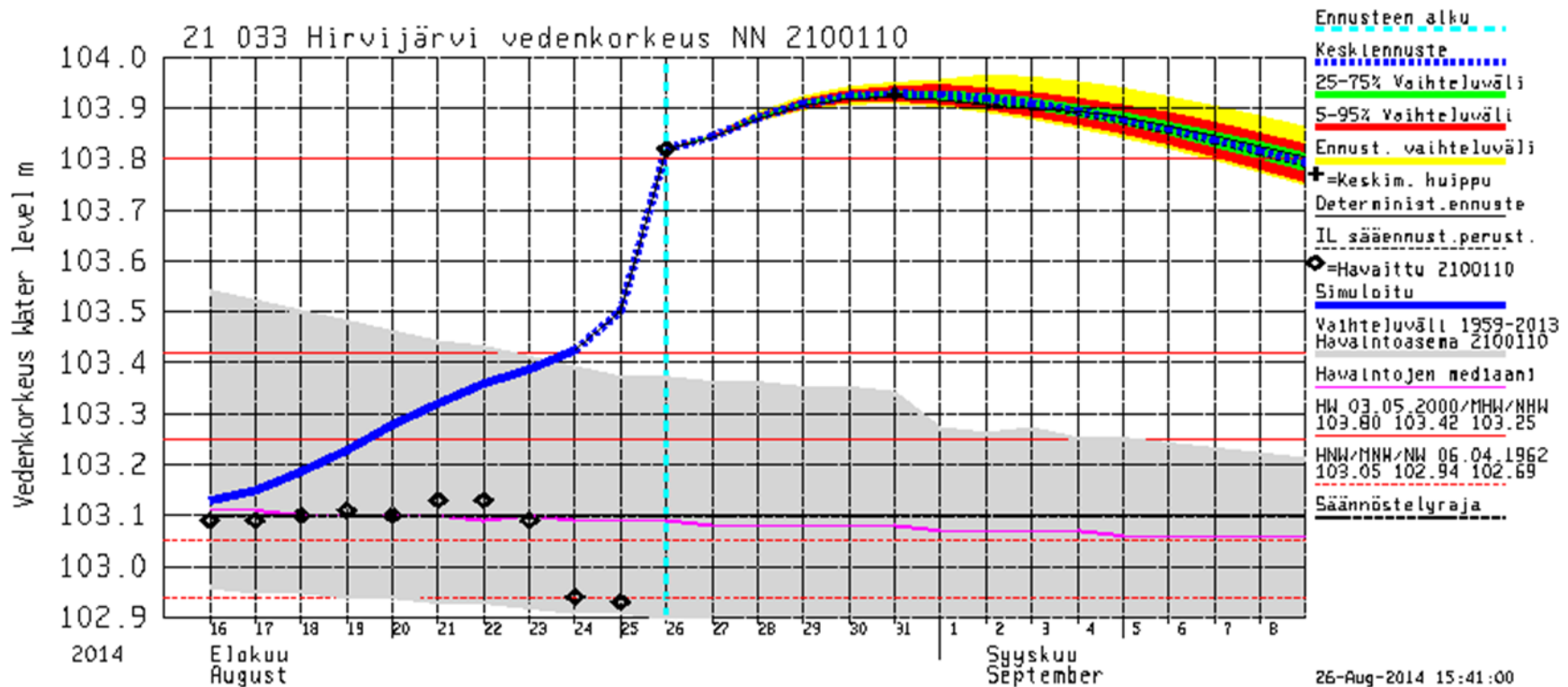

Data transfers in Watershed Simulation and Forecasting System

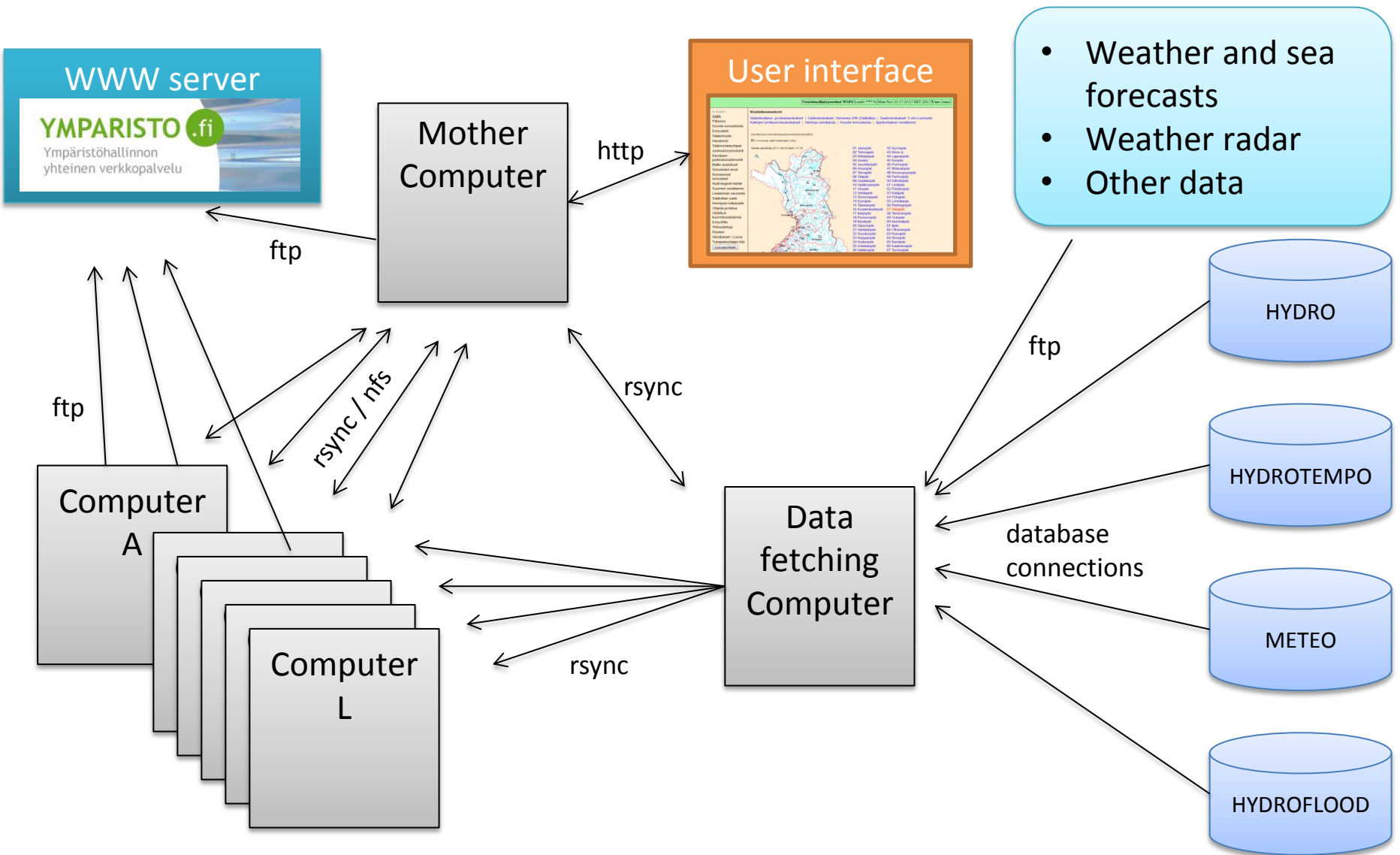

Data Control State Machine

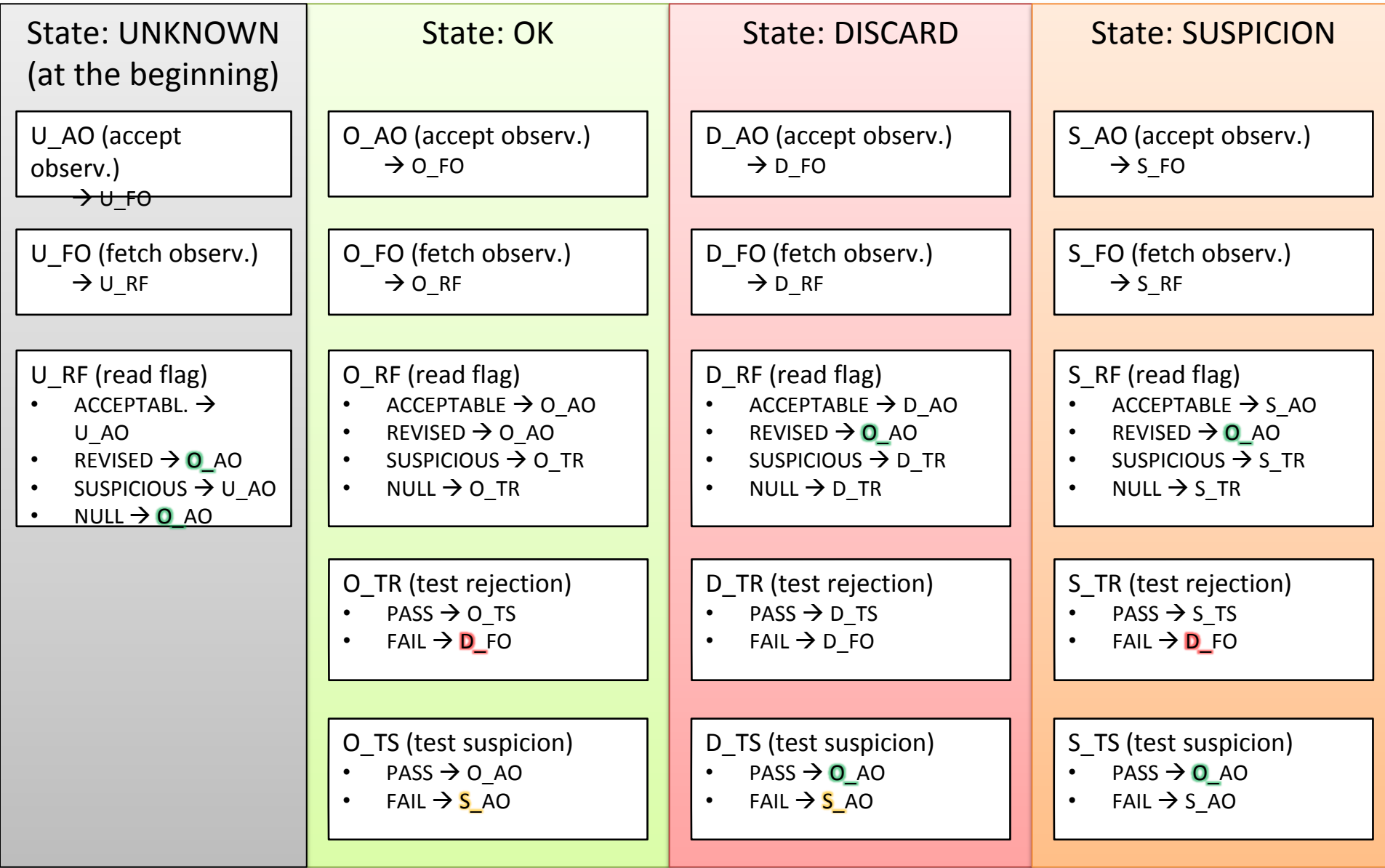



From Sweden:

- 16 precipitation stations
- 15 air temperature stations
- 11 wind stations
- 9 water level stations
- 8 discharge stations
- 8 snow observation places



From Norway:

- 3 snow observation places



From Russia:

- 3 water level stations
- 1 precipitation station

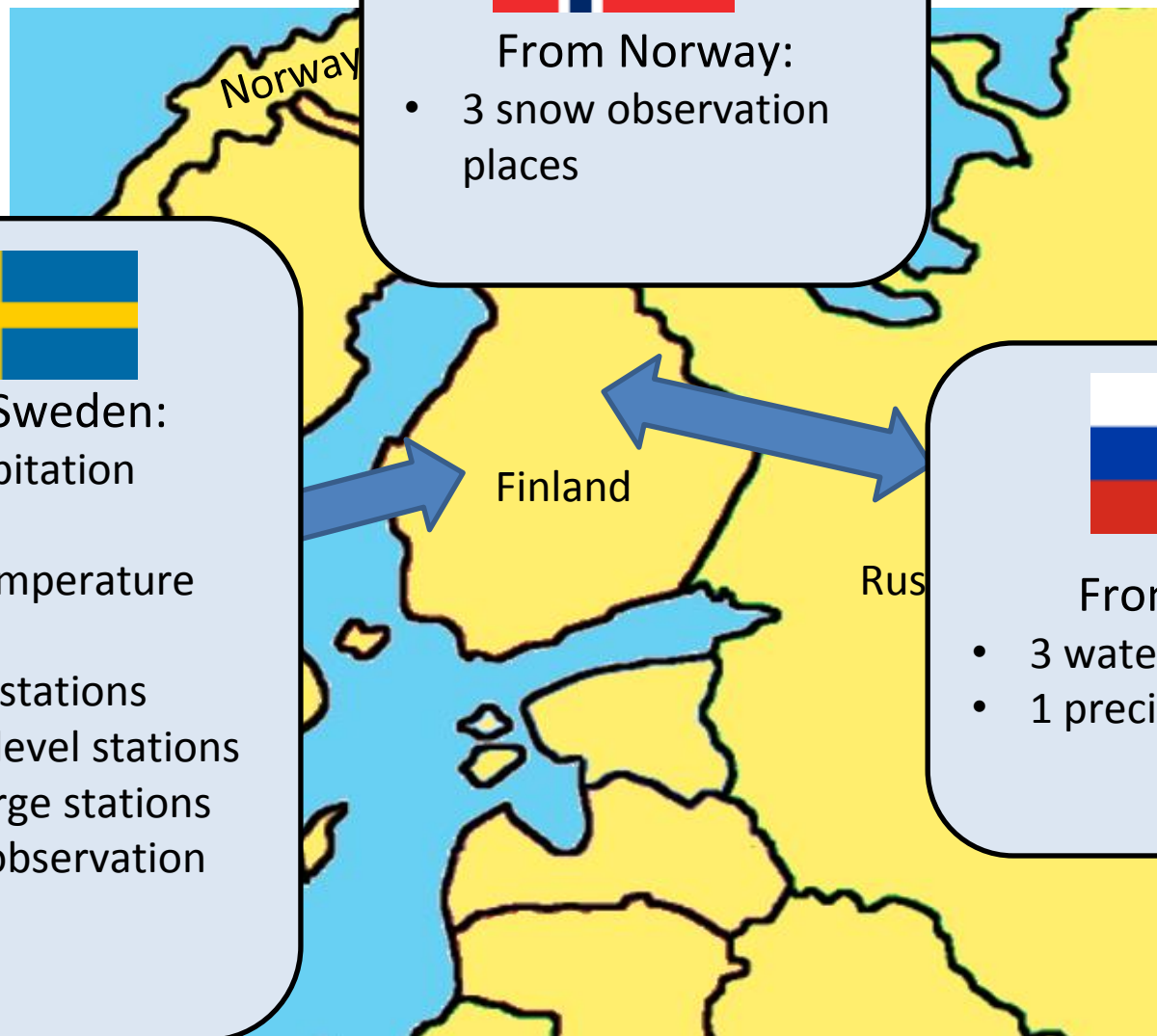



From Sweden:

- 16 precipitation stations
- 15 air temperature stations
- 11 wind stations
- 9 water level stations
- 8 discharge stations
- 8 snow observation places



From Norway:

- 3 snow observation places

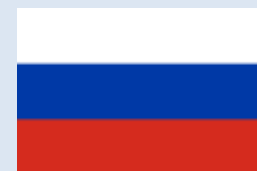

From Russia:

- 3 water level stations
- 1 precipitation station

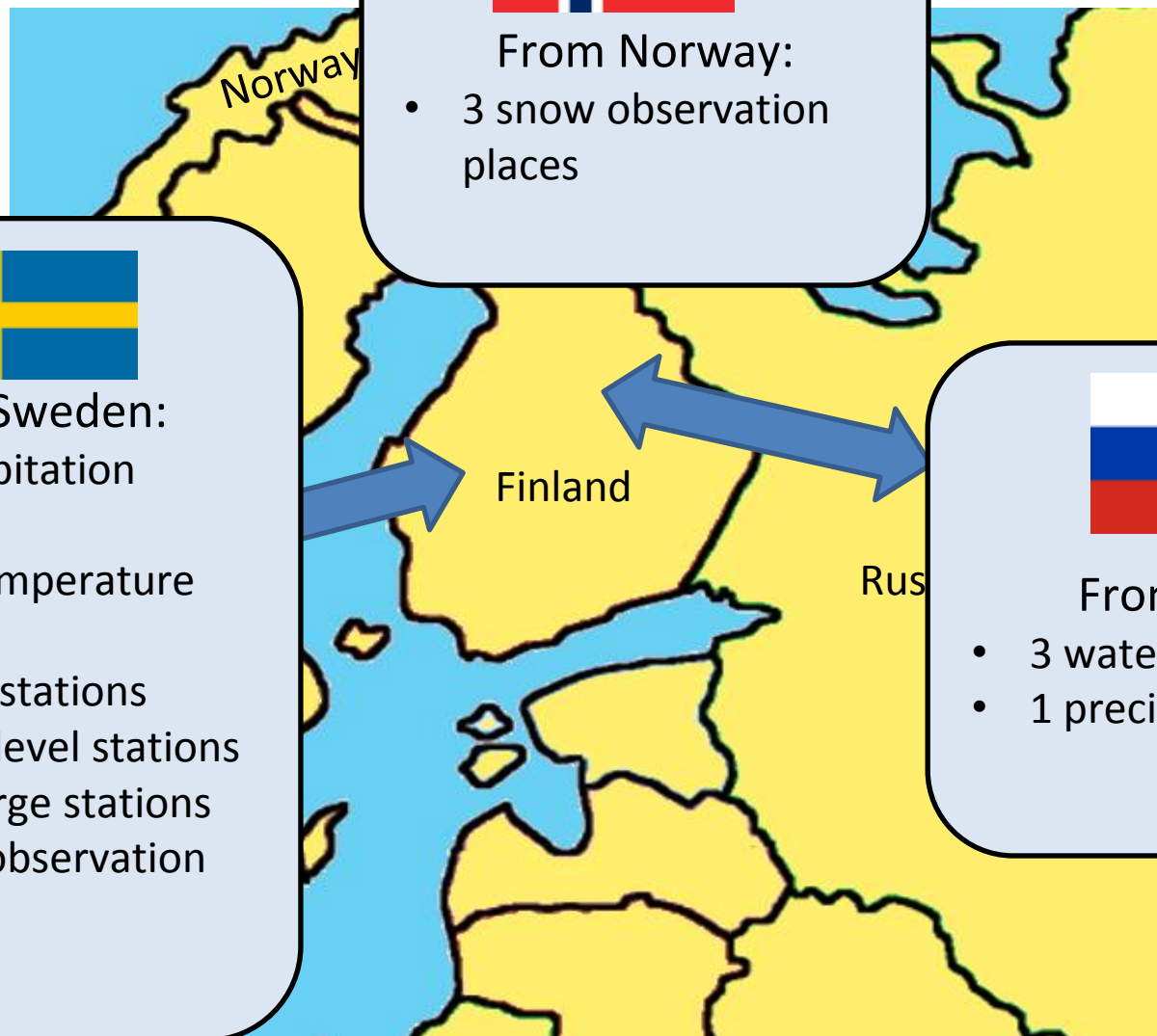

Satellite snow products in WSFS

CryoLand

- Fractional snow cover
- Snow water equivalent

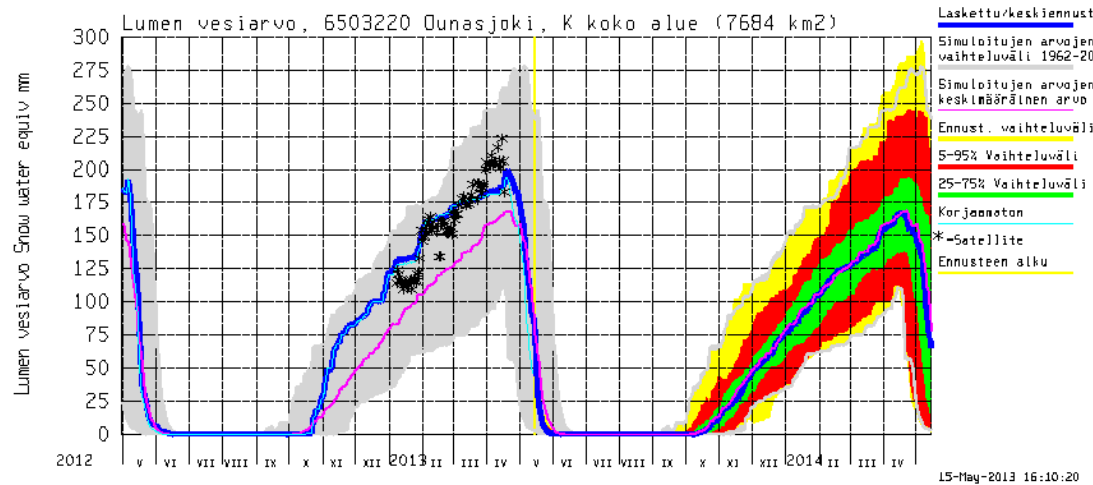
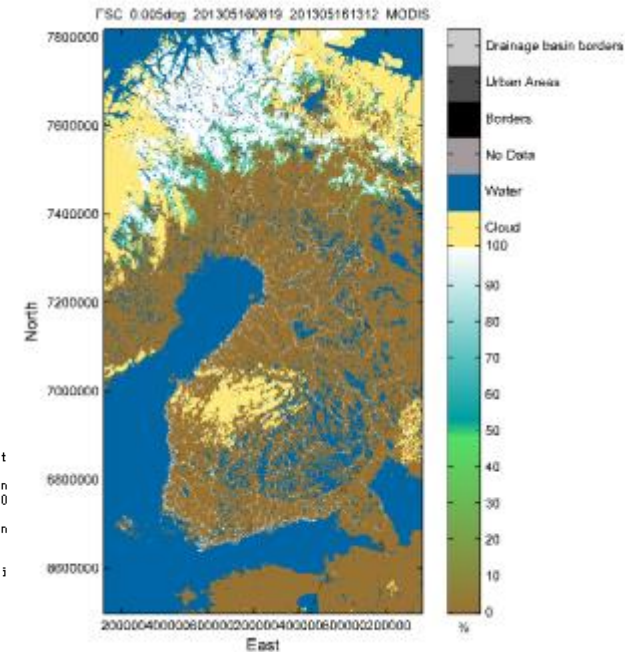

Satellite snow products in WSFS

Fractional snow cover

- Areal snow difficult to estimate
 - FSC provides information about remaining snow in final stage of melting

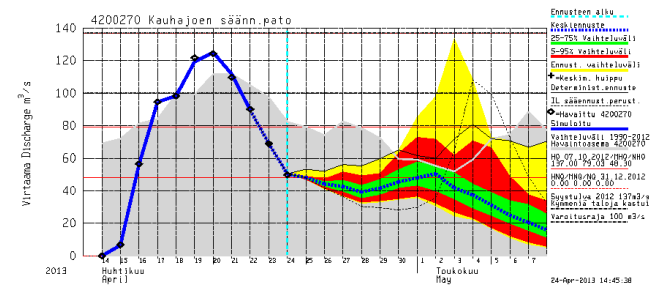
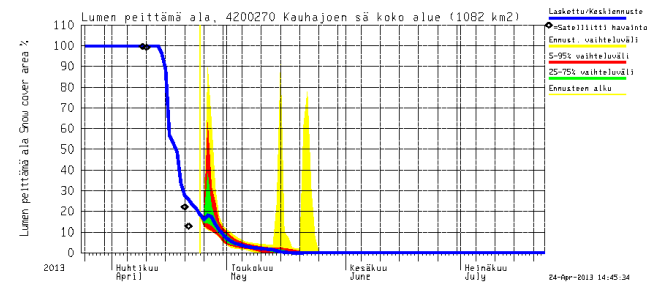

Snow water equivalent

- If modelled snow differs from prec.sum SWE helps
- Has not yet been as helpful as areal snow

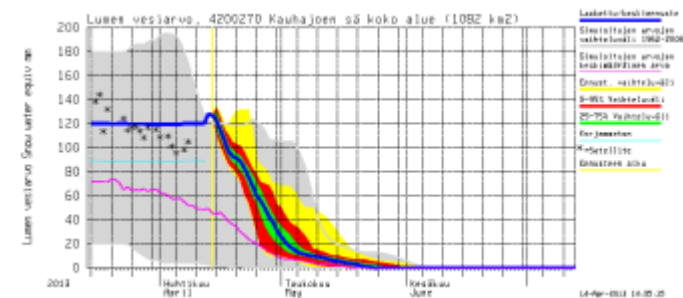

Sea water level realtime observations and forecast 2-5 days ahead for river water level simulation at City of Pori

- City of Pori has biggest risk for major flood damages in Finland

For River Water level simulation we need:

- Discharge simulation and forecast
- Sea water level observations and forecast
- Wind speed & direction observations and forecast

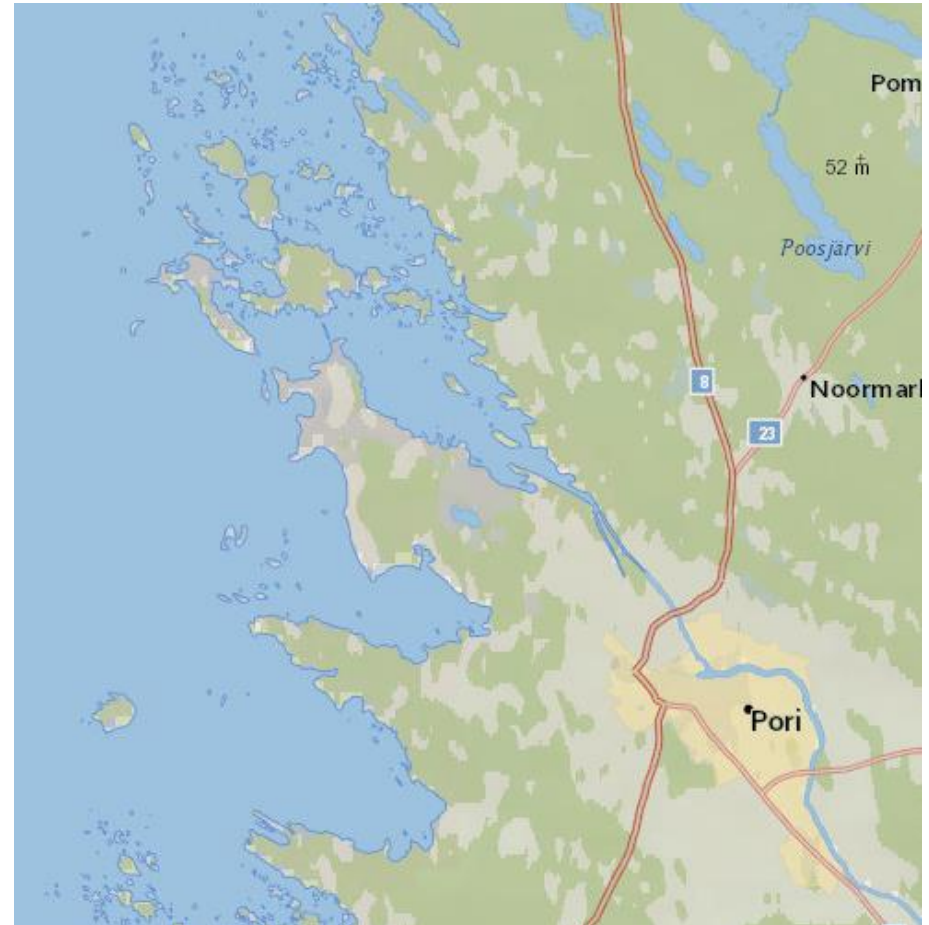

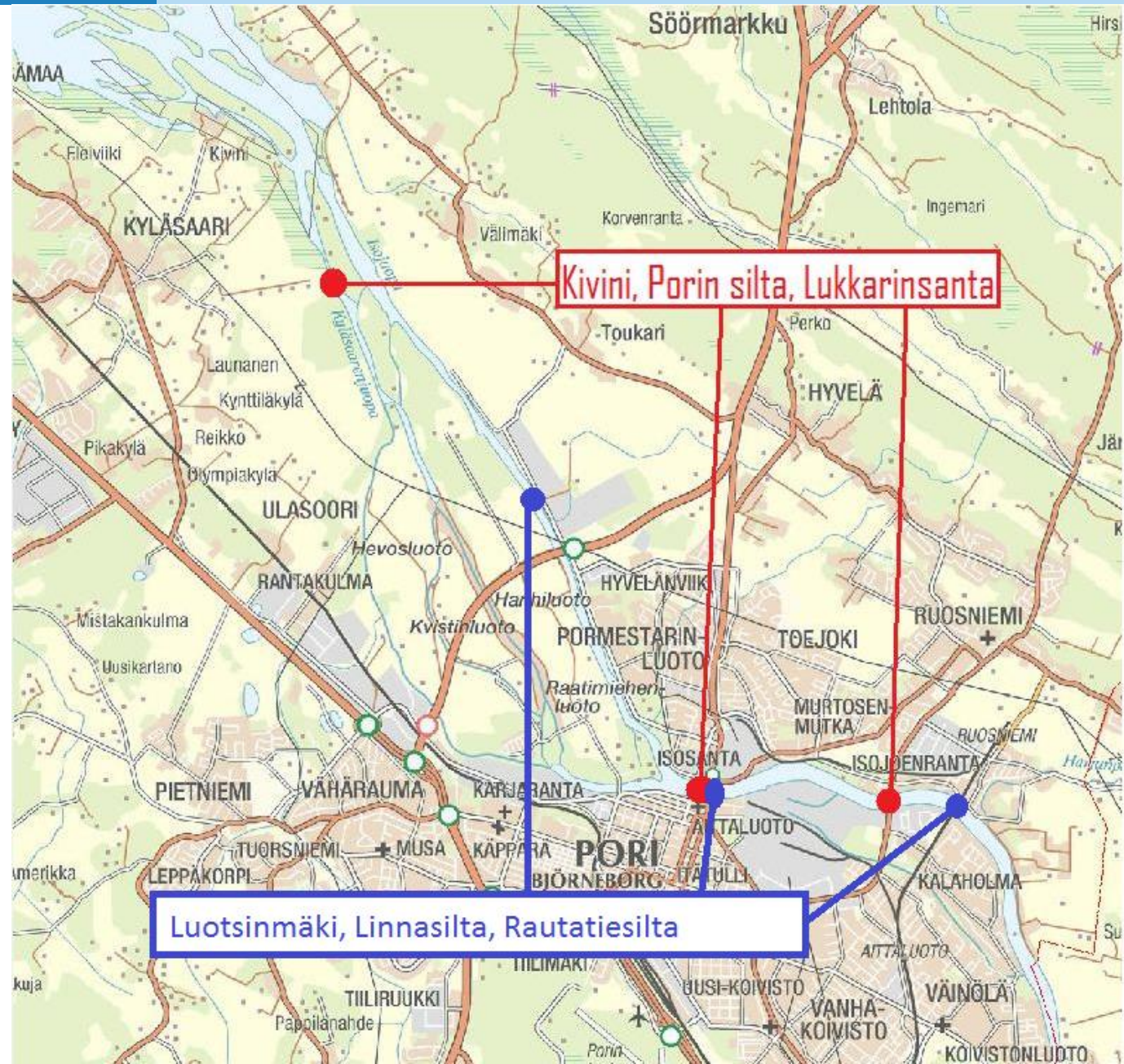

Regulation dam controlled by the hydrological model

- Kaarenhaara dam at Evijärvi is controlled by Watershed Simulation and Forecasting System SYKE-WSFS
- The WSFS model calculates the daily outflow need, based on the inflow forecast (adaptive outflow calculation), and the result is sent to the dam
- The dam adjusts the outflow according to the model, but applies also a safety logic on top of the model's calculation
- The model's outflow for the dam can be manually overridden, if necessary

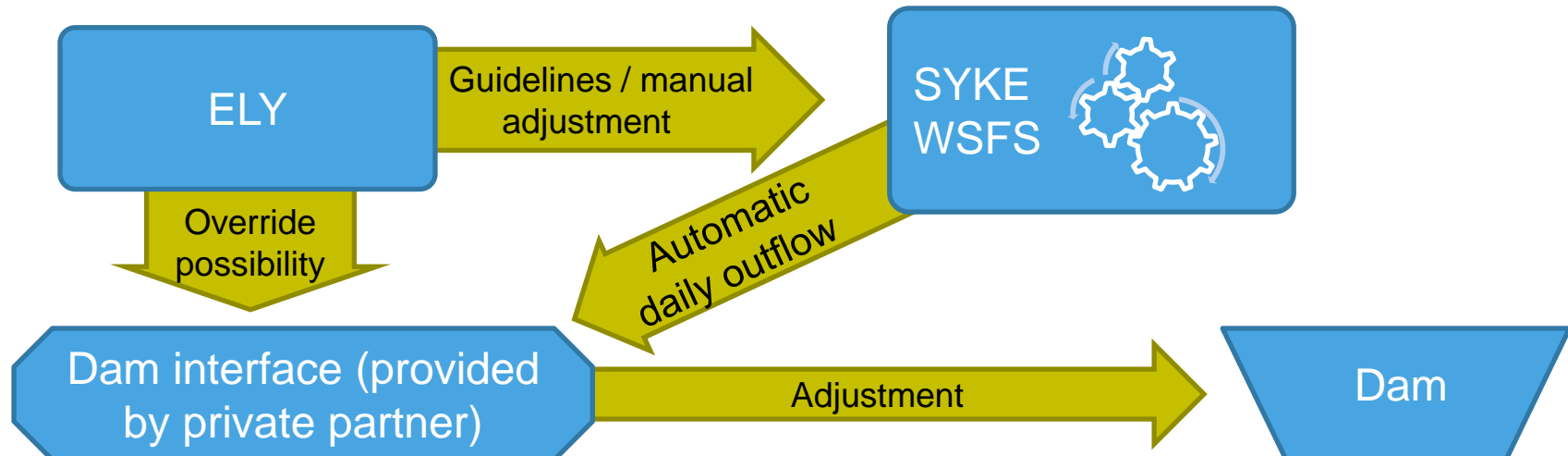

Kaarenhaara dam controlled by WSFS

- Operational since 1.1.2016 (orange vertical line on pictures)
- A "new software's problem" occurred in the beginning of June, and dam control was manually overridden until the problem was fixed

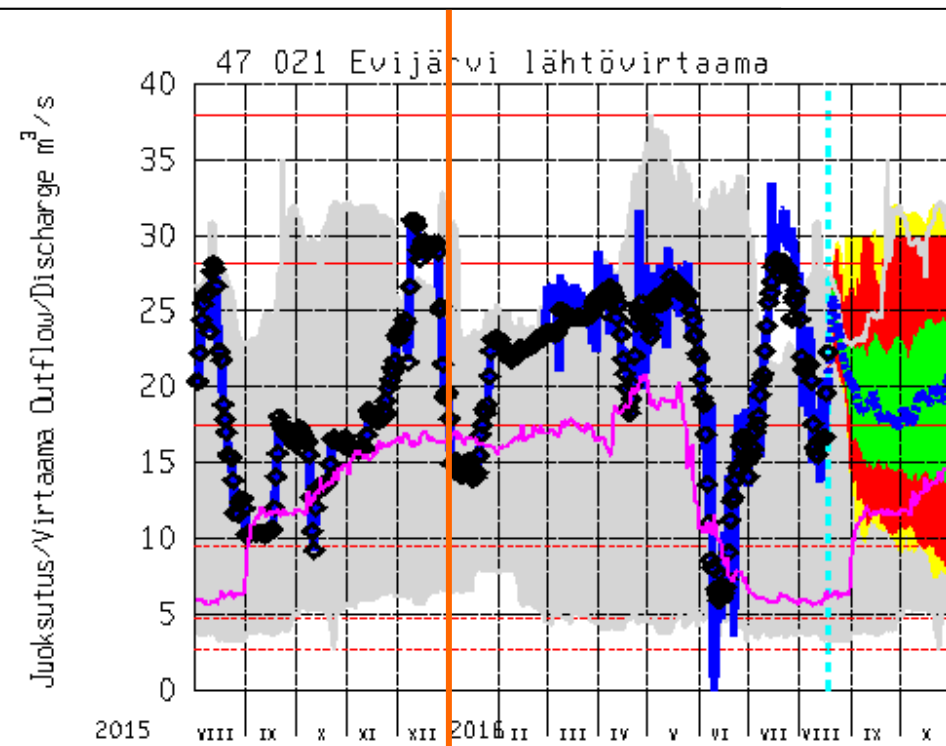
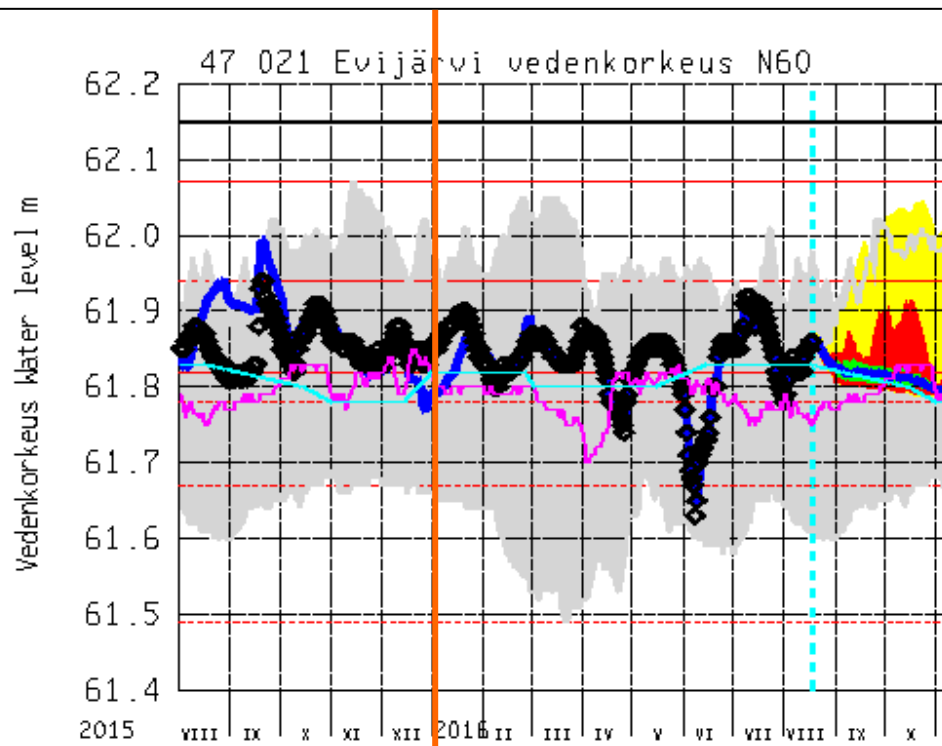

- Water level
- Discharge
- Ice dam risk
- Ice breakup
- Nutrient load
- Evaporation
- Snow
- Runoff
- Groundwater
- Soil moisture
- Hydropower situation

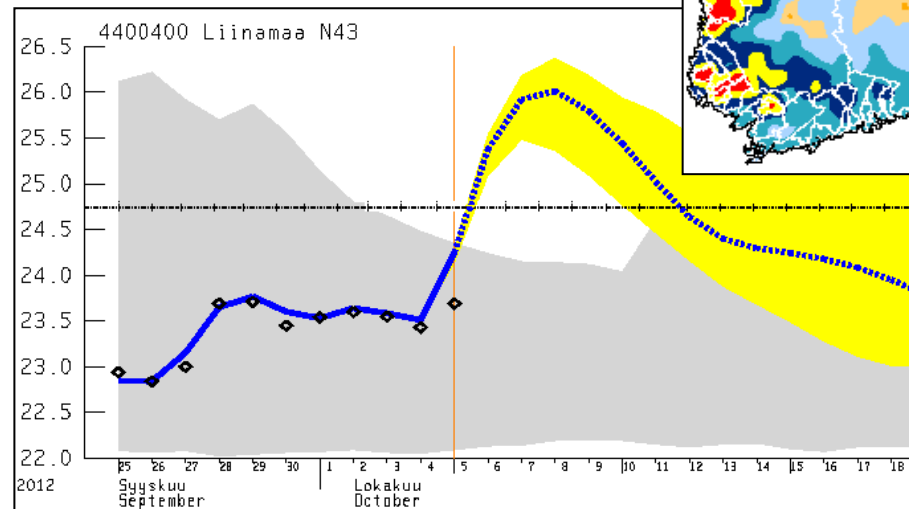
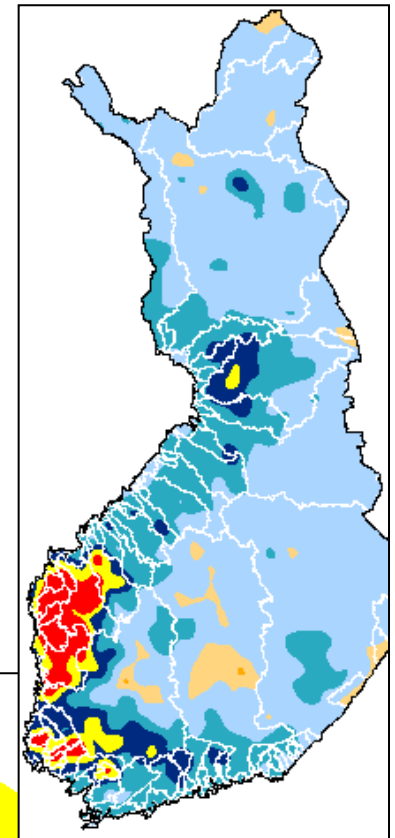
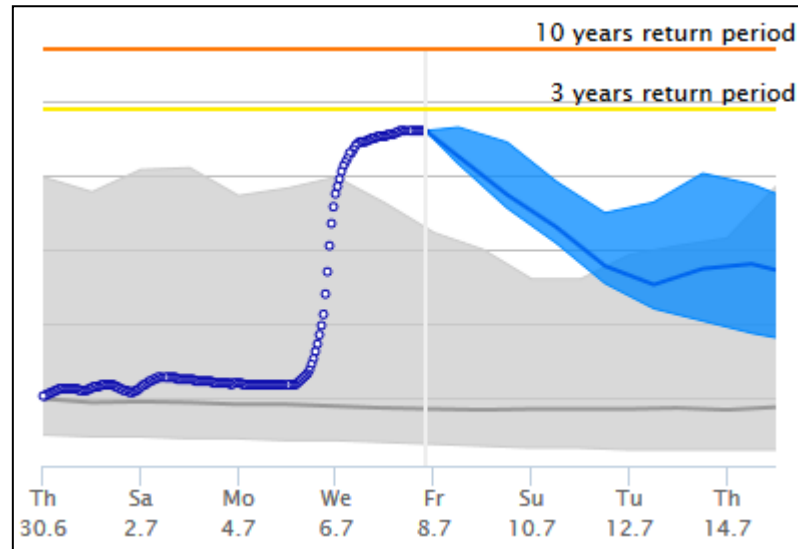

www.ymparisto.fi



wwwi2.ymparisto.fi/i2/90/qpx2/vesitilanne.html



Google

Vesitilannekartat: Valunta Tulvatilanne

Kuva päivältä:
06.07.2016

Vesitilannekartat

Valunta / Tulvatilanne

Vedenkorkeus

Tulvavaara

Vuorokausisadanta

30 vrk sadesumma

Järven jäänpaksuus

Lumen vesiarvo / Lumikuorma

Lumen syvyys

Lumen sulanta

Lumen tiheys

Lumen tiheys aukealla

Lumen tiheys metsässä

Routa

30 vrk maahaiduntasumma

Maankosteuden vajuus

Pohjavesi

Vuorokauden keskilämpötila

Järven pintalämpötila

Tarkemmat kartat

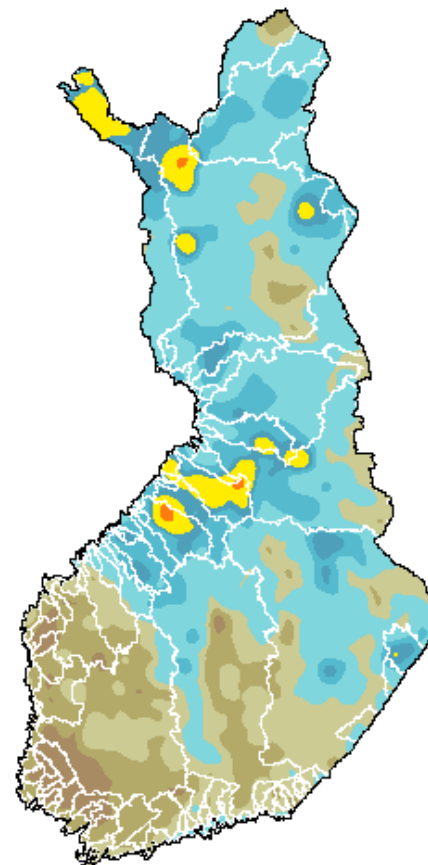
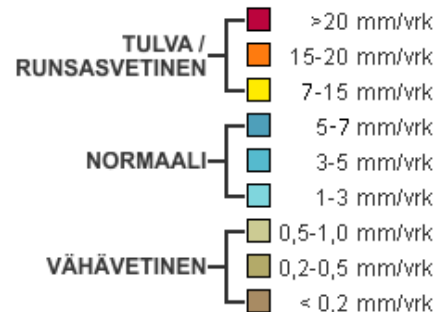

28.06.2016

29.06.2016

30.06.2016

01.07.2016

02.07.2016

03.07.2016

04.07.2016

05.07.2016

06.07.2016

tänään

08.07.2016

09.07.2016

10.07.2016

11.07.2016

12.07.2016

13.07.2016

14.07.2016

Päivitetty 07.07.2016 20:00

Kartta on linkki vesistöennusteisiin

Kartta kuvaa parhaista

Realtime forecasts and maps for over 600 lakes and rivers available online:

<http://www.environment.fi/waterforecast>

<http://www.ymparisto.fi/vesistoennusteet>
(in Finnish)



Päijänne Kalkkinen vedenkorkeus

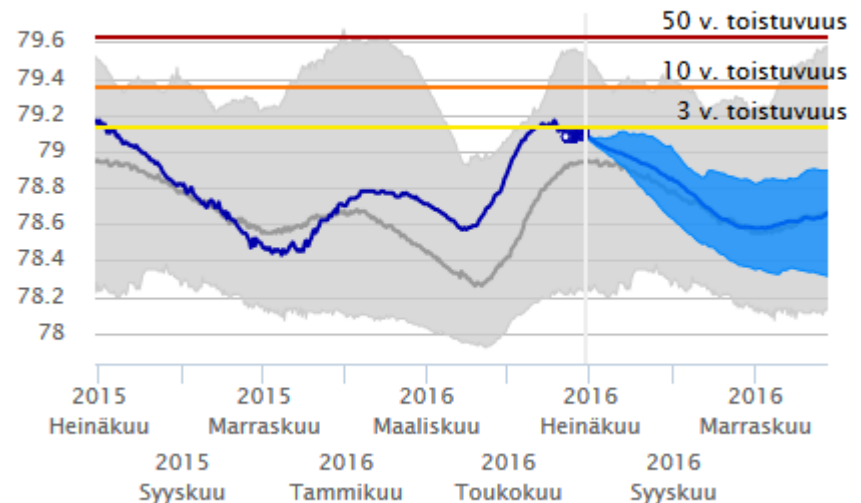

AUTOMATIC WARNINGS FOR HIGH WATER LEVELS AND GREAT DISCHARGES

- Up to 9 days ahead, even 30 days ahead with big slowly changing lakes like Saimaa
- Warnings are based on
 - *realtime observations and forecasts*
 - *potential damages and consequences*

- Direct delivery to subscribers



- Warnings available online:

www.environment.fi/waterforecast

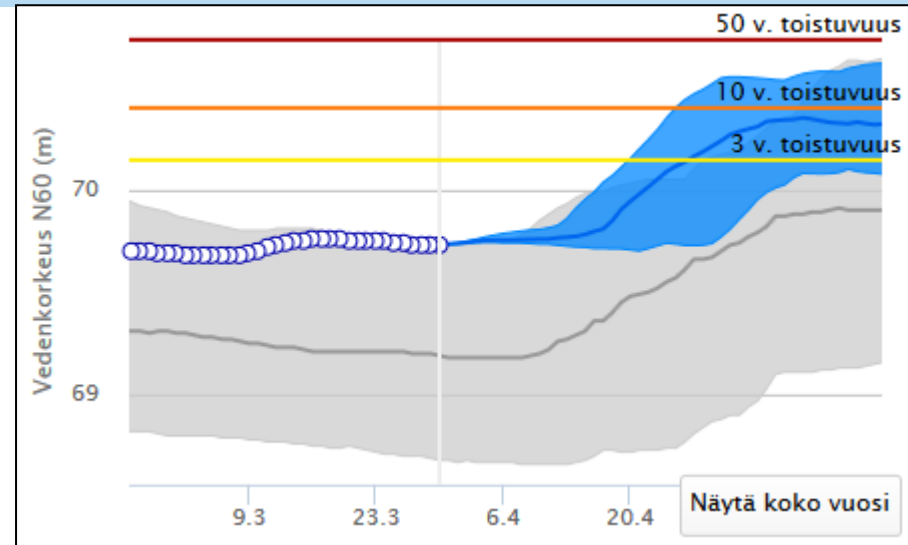

Oulankajoki (Kiutaköngäs)

Warning: forecasted water level exceeds limit of Karhunkierros hiking route to be cut off.

Observed water level 26.5.2014 klo 12 is NN+88,92 m.



Karhunkierros hiking route will be cut off if water level exceeds NN+90.00 m.

Forecasted water level peak NN+90.50 m is at 29.5.2014.

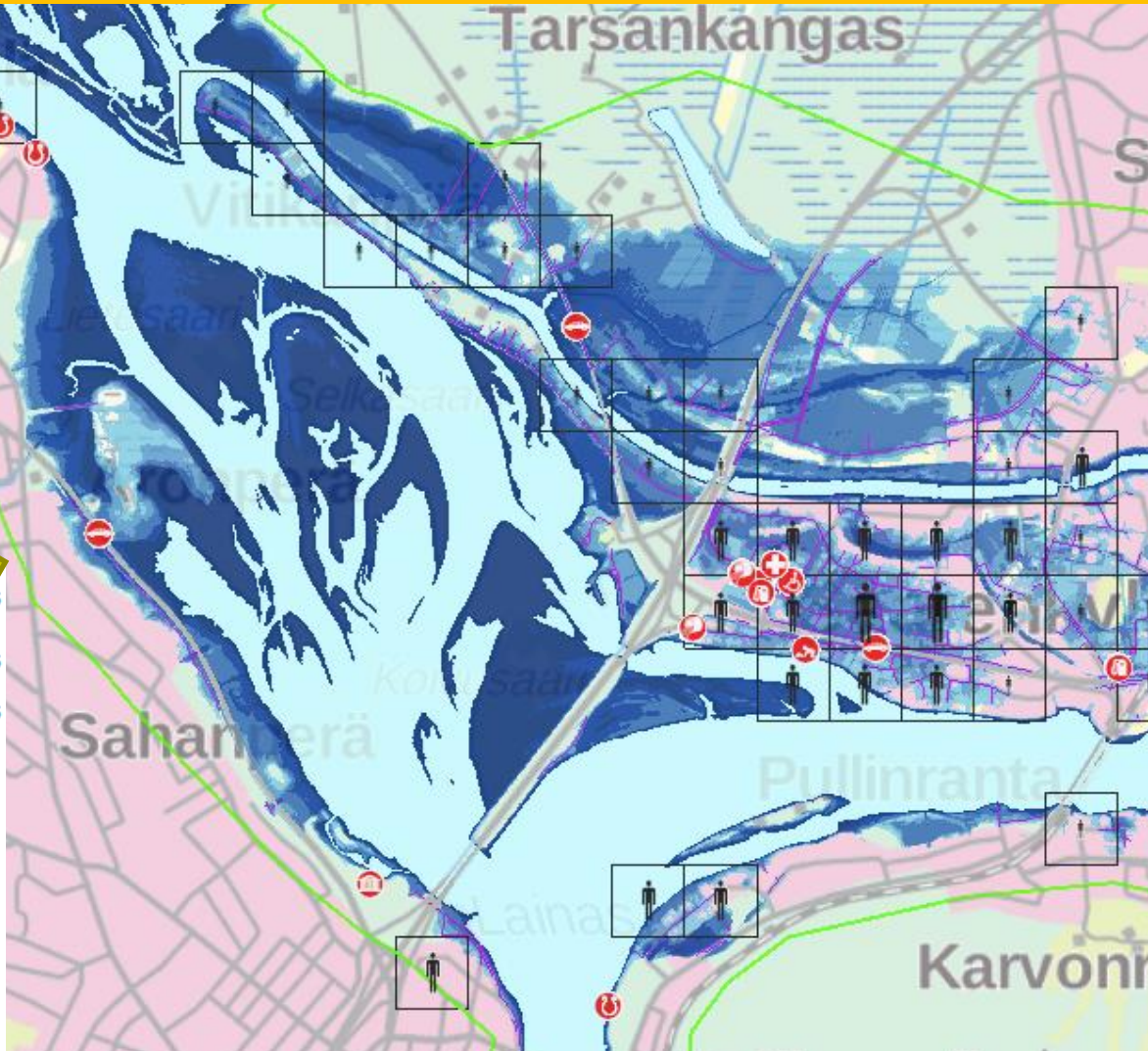
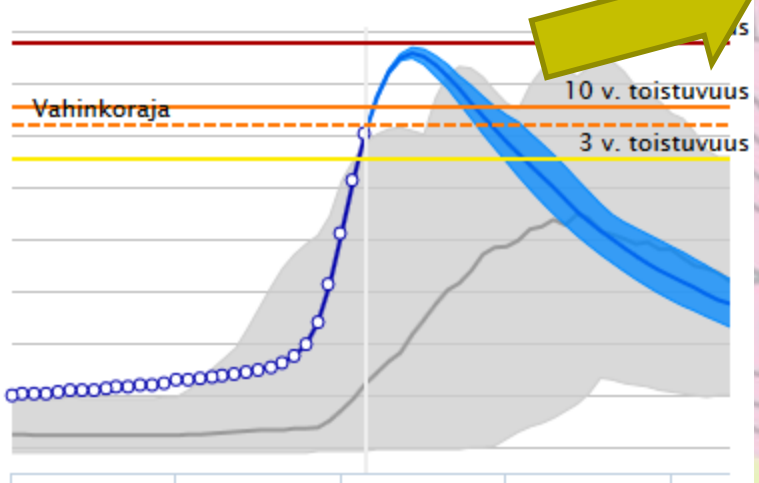
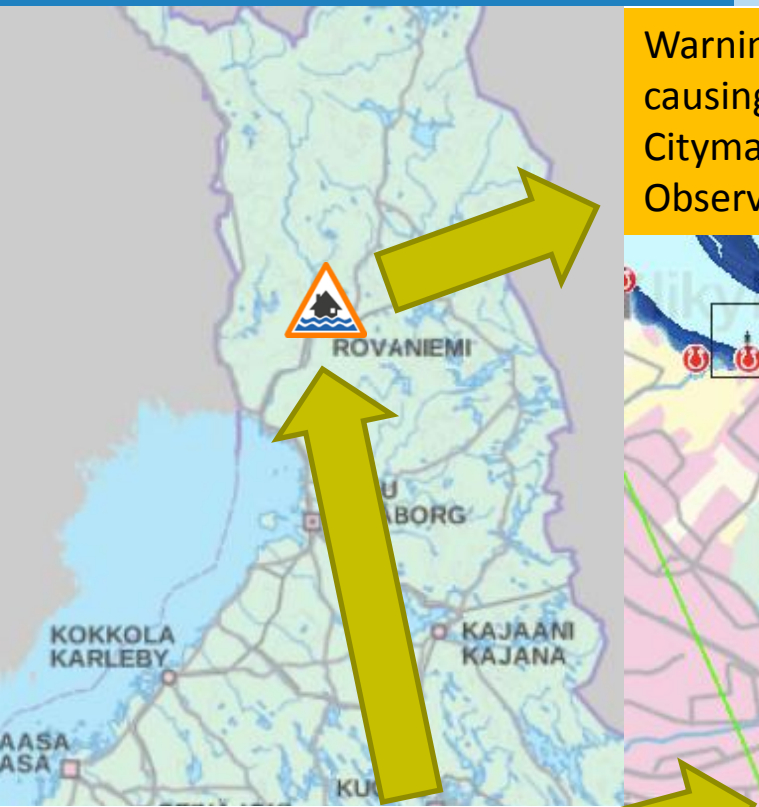
Warning: forecasted water level exceeds flood damage limit 77.45 m, causing 0,5 km² flood area with 50 inhabitants and flood damages at Citymarket shopping mall.
Observed water level 26.5.2014 klo 12 is 76.32 m.



Warnings are based on impact / potential damages and consequences, when possible (otherwise return period)

Symbol	Warning	Description / impact / potential damages	Return period (preliminary value)
	Very dangerous flood	"Danger to human life and health"	Over 50 years
	Dangerous flood	"Damage to buildings"	10-50 years
	Flood	"Anything which differs flood-wise from normal casual everyday life"	3-10 years

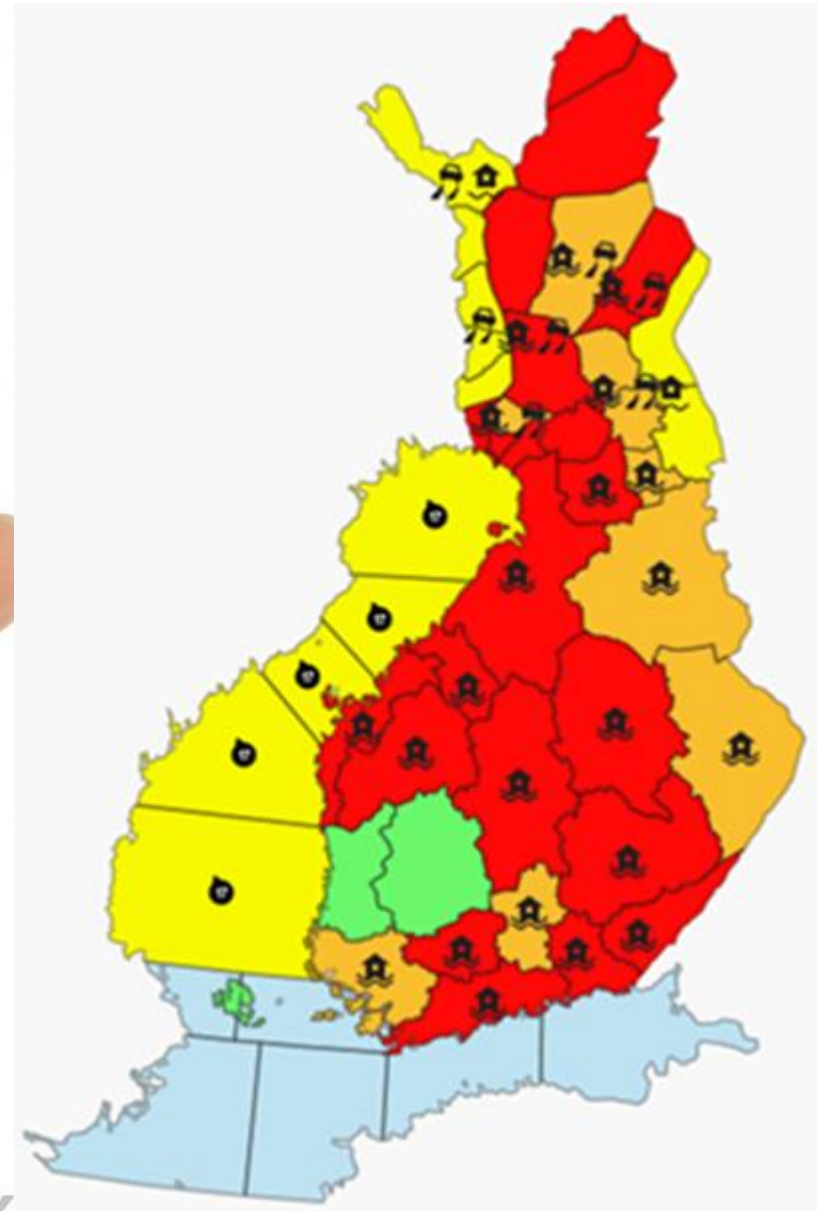

Realtime forecasts and warnings are available online:

<http://www.ymparisto.fi/ennusteetjavaroitukset>

(In Finnish, Swedish and English, and in Russian for transboundary waters)

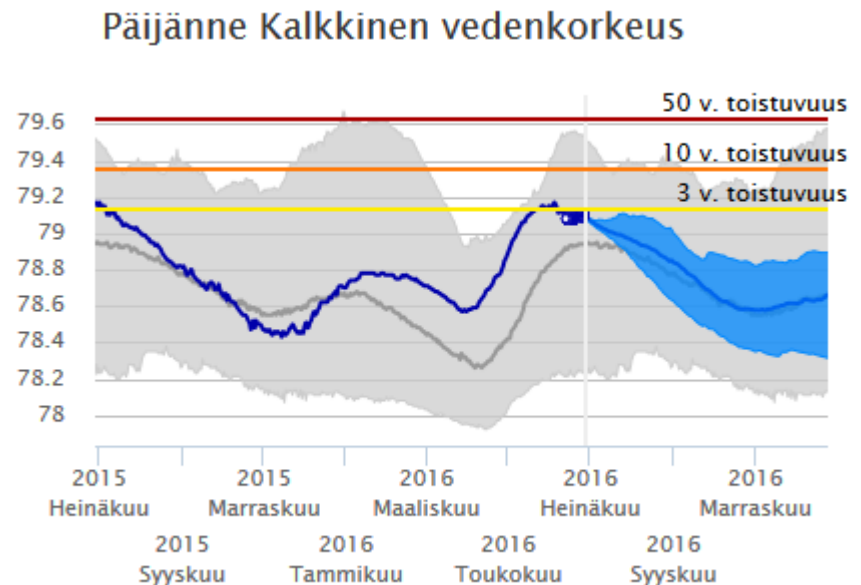

Structure of WSFS-Vemala water quality model

- Phosphorus and nitrogen leaching from fields and forest
- Point sources, scattered dwelling and deposition
- Transport and retention in rivers and lakes
- Field level description
- Covers all Finland

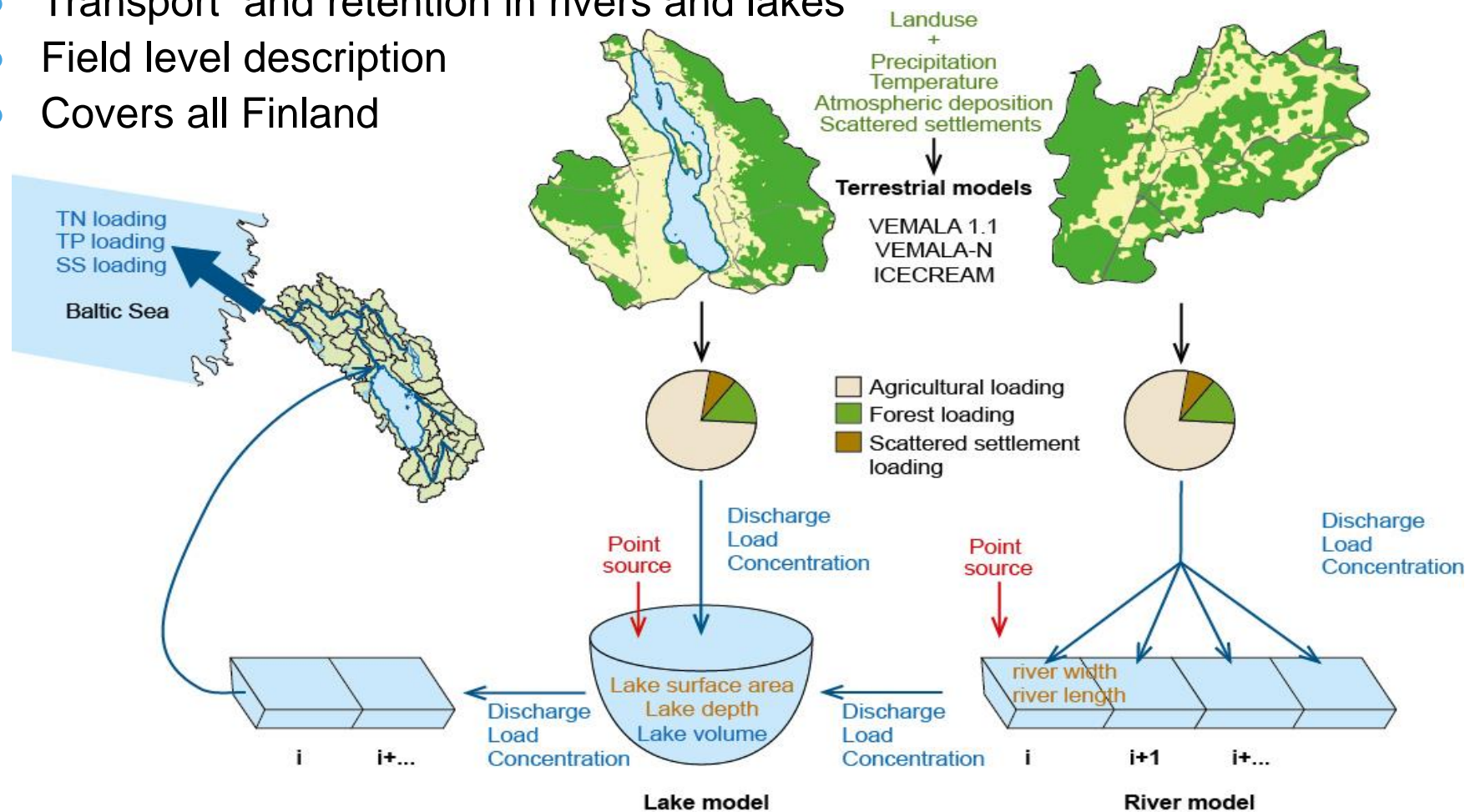

Realtime and annual phosphorus load from Finland to Baltic sea

Mean annual riverine phosphorus load from Finland (3750 t / year)

Finnish rivers in the Baltic sea area

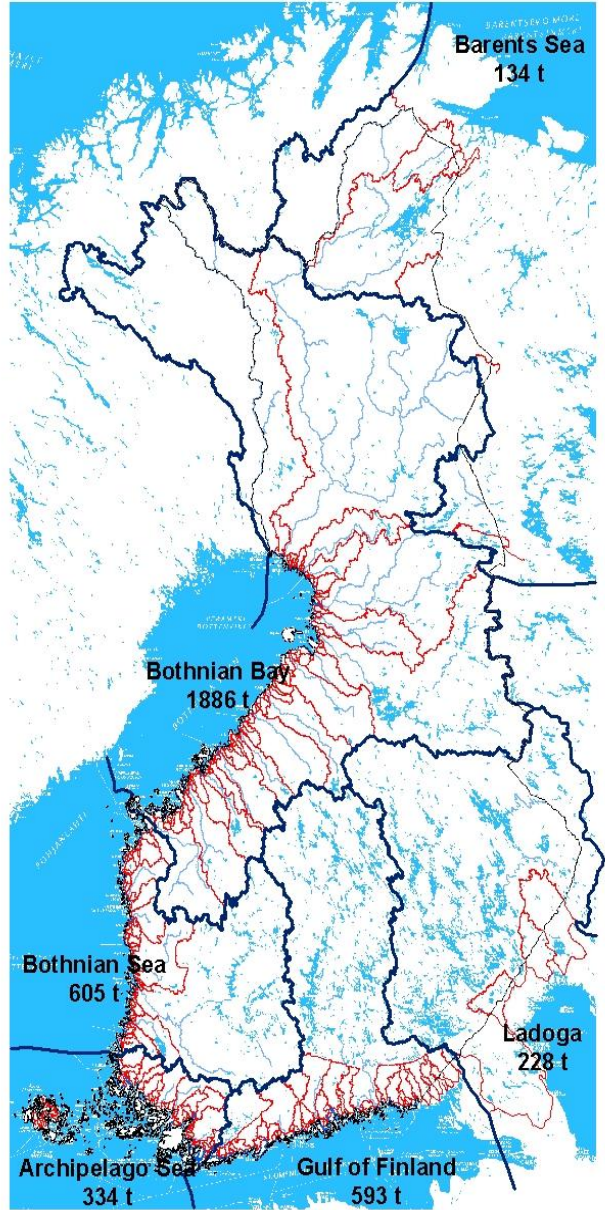
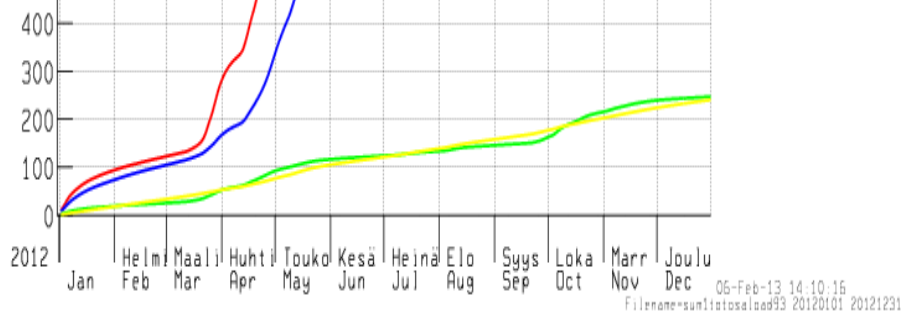
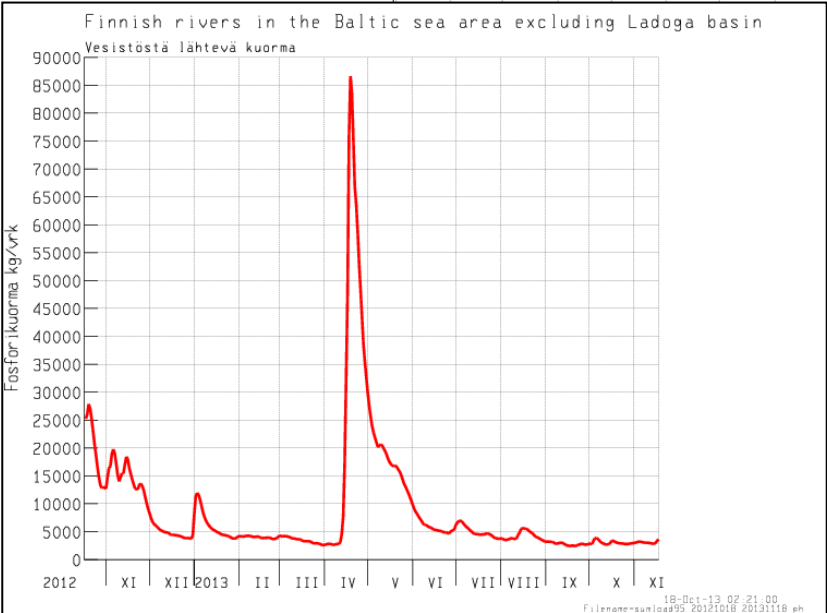
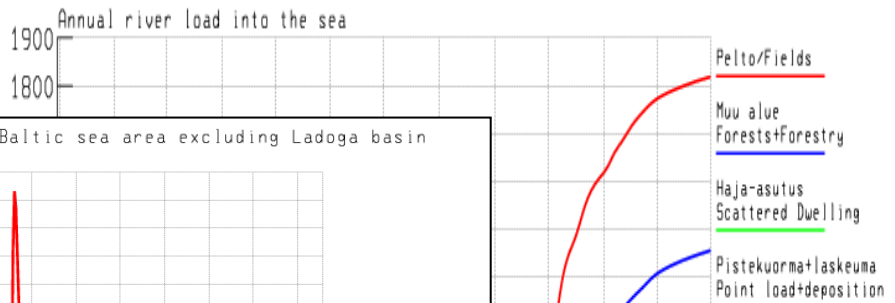

Simulation of a leak from mine

The aim is to better predict the transport of substances in rivers and lakes downstream of an industrial leak for determining toxicity risks:

- Simulation of a hypothetical 1 tonne of Nickel discharged on the 09/11/2014 into the freshwater ecosystem from Talvivaara

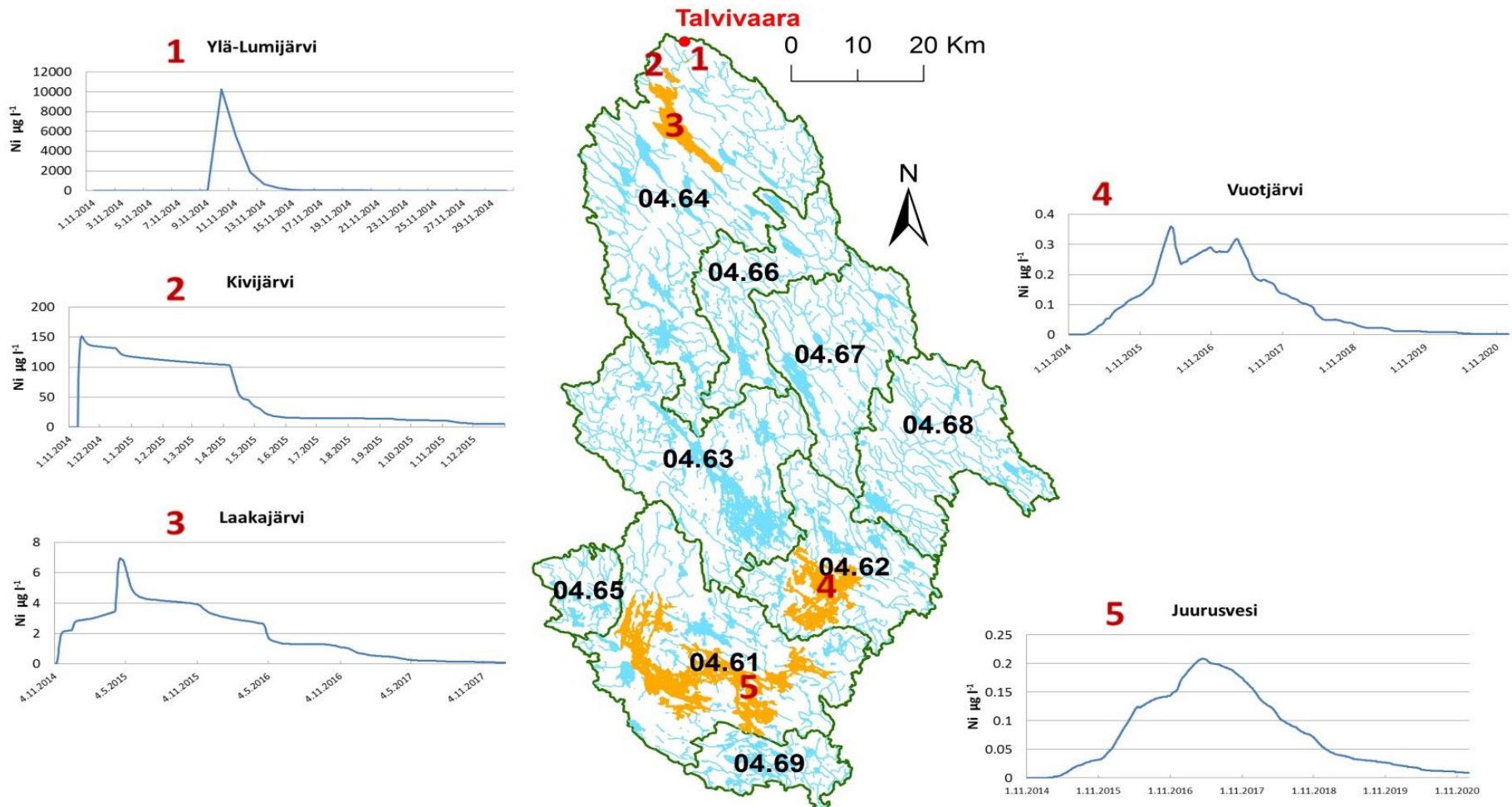

Version	Substance	Hydrological model	Terrestrial model		River model	Lake model
			agricultural loading	non-agricultural loading		
VEMALA 1.1	TP, TN, SS	WSFS	concentration-runoff relationship	concentration-runoff relationship	nutrient transport model (Section 2.1.5.)	nutrient mass balance model (Section.2.1.6.)
VEMALA-ICECREAM	TP	WSFS	field scale process based model	concentration-runoff relationship		
VEMALA-N	TN, NO ₃ ⁻	WSFS	semi-process based, 5 crop classes	semi-process based, 1 forest class		
VEMALA v.3	TN, TP, SS, TOC, PO ₄ ³⁻ , PP, Porg, NO ₃ ⁻ , NH ₄ ⁺ , Norg, Phytoplankton, O ₂	WSFS	VEMALA-ICECREAM (TP), VEMALA-N (NO ₃ ⁻ , Norg), VEMALA 1.1 (SS, TOC)		Biogeochemical model	Biogeochemical model

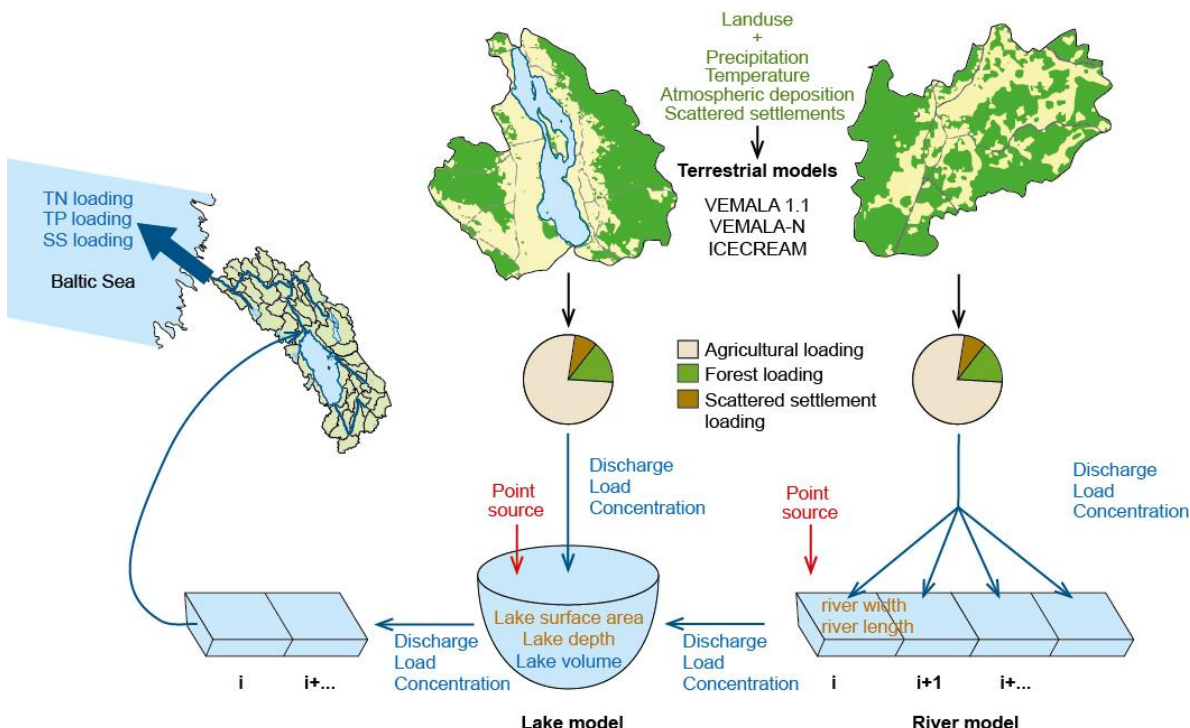

VEMALA-N

- Simulates NO_3^- , N_{org} and TN leaching and load formation at a catchment scale
- Simulation unit is crop/land use class and there are 5 agricultural crop classes and forest
- Model simulates dependency of the main processes (mineralization, nitrification, denitrification, plant uptake) on the soil moisture and temperature

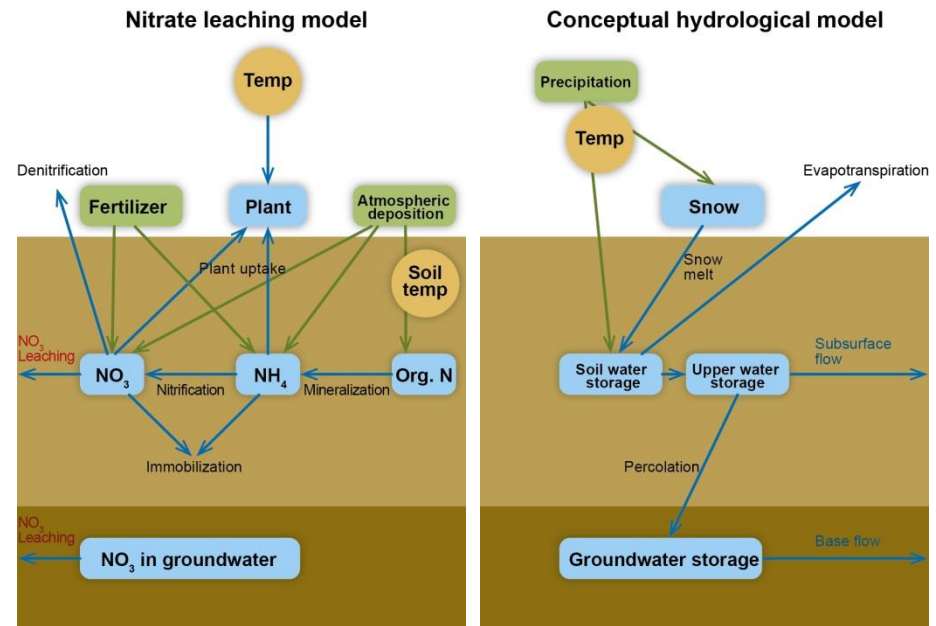

Scenarios:

- Model can be used to simulate the effect of changing climate on the nitrate leaching and its sub-processes
- Model can be used to simulate effect of changing crop and fertilization (both mineral and organic) on the nitrate leaching

DEMOLA-ICECREAM

- Simulates particle bound and dissolved phosphorus (PP and DP) load and erosion from agricultural areas
- Field-scale, process based model, applied to all fields in Finland
- Field characteristics: soil type (clay, silt, coarse and peat), field slope and the size of a rectangle-shaped field plot
- Output from ICECREAM (daily total P load) is used as input to DEMOLA

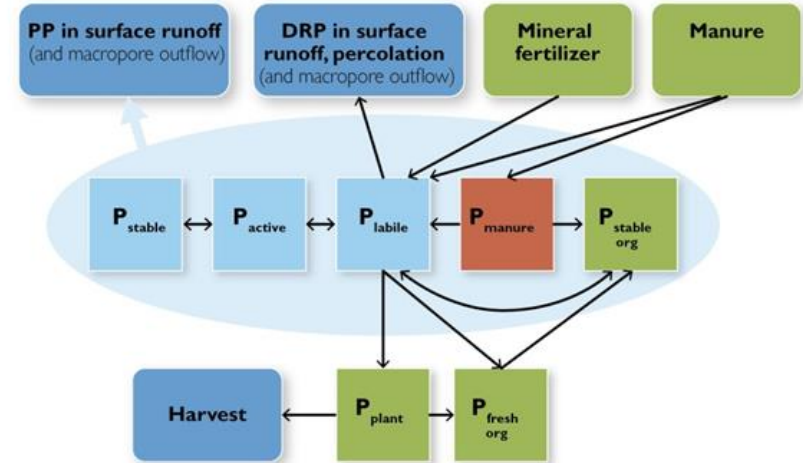

- Agricultural measures in ICECREAM:
 - Amount, depth of application and type of fertilizer (mineral/manure)
 - Annual crops (also over winter), perennials and root crops, 13 different crops parameterized
 - Conventional tillage, direct sowing
 - Dates for agricultural practices
 - Buffer zones/strips

VEMALA v.3

- VEMALA v.3 uses the terrestrial input from VEMALA-N for NO_3^- and Norg, VEMALA-ICECREAM for PO_4^{3-} , PP and Porg and VEMALA 1.1 for TOC and SS.
- The phytoplankton growth is simulated using the AQUAPHY model (Lancelot et al. 1991) and the nutrient cycling using a simplified version of the biogeochemical model RIVE (Billen et al., 1994).
- In this new model, the bioavailable nutrients are no longer modeled separately but are linked in the aquatic ecosystem to one another through phytoplankton dynamics, organic matter degradation and sedimentation.
- It can simulate:
 - The proportion of biologically available fractions in the run off to the Sea
 - The contribution of the different loading sources to the biologically available nutrients
 - The impact of the different farming actions and loading reduction actions on the biologically available nutrient loads
 - The phytoplankton growth in Finnish water bodies
 - The better simulation of retention in the river network.
 - The effect of climate change on the biologically available nutrient fractions

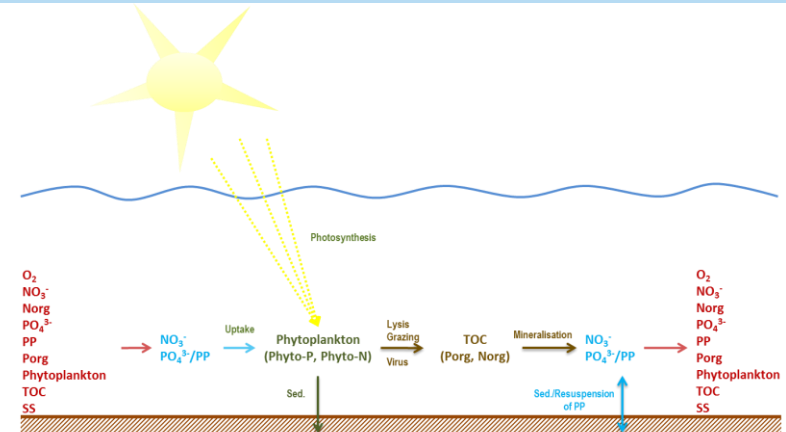

- Variables simulated in VEMALA v.3
 - Phosphate (PO_4^{3-}), dissolved organic phosphorus (Porg) and particulate inorganic phosphorus (PP)
 - Nitrate (NO_3^-), ammonium (NH_4^+) and organic nitrogen (Norg)
 - Phytoplankton
 - Suspended solids (SS)
 - Total organic carbon (TOC)
 - Oxygen (O_2)

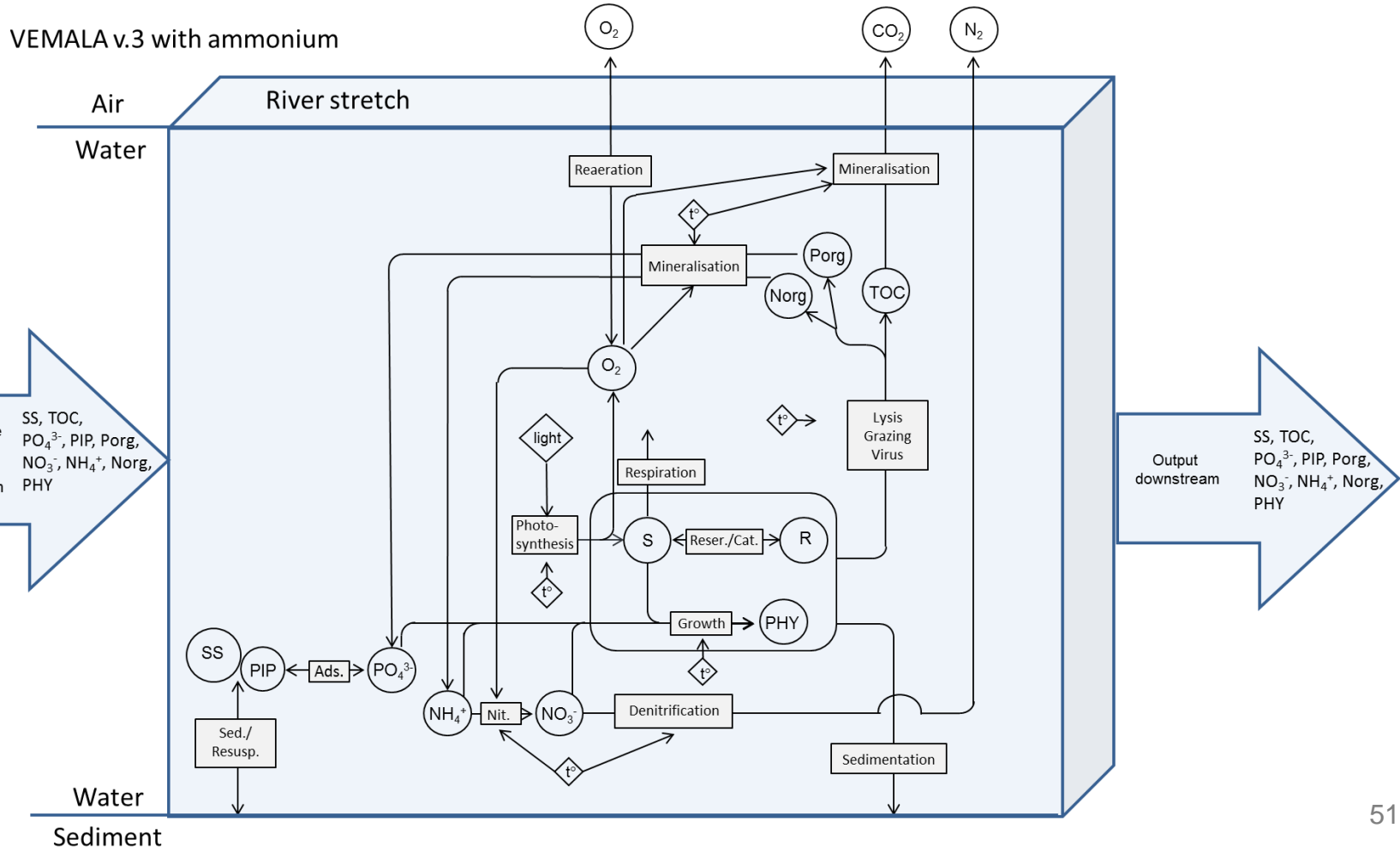

Where can it be used?

- It can simulate:
 - The proportion of total or biologically available fractions in the run off to the Sea
 - The contribution of the different loading sources to the total or biologically available nutrients
 - The retention in lakes and the river network.
 - The phytoplankton growth in Finnish water bodies
 - Scenarios:
 - The impact of the different farming actions and loading reduction actions on the total or biologically available nutrient loads
 - The effect of climate change on the total or biologically available nutrient fractions

- VEMALA can help in the WFD implementation

- Impact of the mining industry

For implementation of WFD it provides:

- For each about 58 000 lakes an estimate of the present state
- Understanding reasons for the state of the lake by dividing the loading by sources
- Scenarios for future with different load reduction options and the effects of climate change

Field id	Name	Slope %	Area ha	Phosphorus leaching kg/ha/a
7620256645	Pihantaus	4.47	16.93	1.7
7620330205	Rikkasuo 1	5.34	6.59	1.61
7620520262	Nivonniska	3.47	4.02	1.59
7620254827	Inganmäki	3.75	3.8	1.54
7620239164	Koskenniska	0.69	2.71	1.4
7620262305	Väliaho	3.03	4.02	1.22
1400111639	Paskosuo	2.29	3.47	1.02
1400072031	Vinkuanlahti	2.35	6.08	0.9

Lake id	Name	Phosphorus concentration ug/l	Incoming load kg/a	Fields kg/a	Forest kg/a	Scattered dwelling kg/a	Point sources kg/a	Load out kg/a
04 582 001	Vinkuanlahti	42.84	15172.83	6235.78	7238.96	660.38	1037.68	15114.44
04 582 002	Sulkavanlahti	134	139.04	115.47	15.3	7.41	0.86	137.43
04 582 003	Vehkalampi	115.09	4.3	3.71	0.29	0.17	0.13	2.72
04 582 004	Kivilampi	104.29	27.66	21.22	4.33	1.84	0.28	26.52
04 582 005	Rajalahti	60.23	17.05	8.85	5.07	1.8	1.33	13.86
04 582 006	Pentanlahti	41.61	14876.35	6082.15	7256.38	647.03	890.75	14745.66

VEMALA tool for simulation transport of heavy metals and harmful substances

- Real time forecast for transport of a leak or waste water
 - Concentration downstream of the leak
 - Comparison to harmful concentration levels
- Operational over Finnish waters
- Simulated substances:
 - Zinc (Zn), Lead (Pb), Mercury (Hg), Aluminium (Al), Cadmium (Cd), Nickel (Ni), Uranium (U), Iron (Fe), Chromium (Cr), Manganese (Mn), Magnesium (Mg), Sodium (Na), Copper (Cu), Sulphur (S), Calcium (Ca), Sulphate (SO_4^{2-}), Silica (SiO_2), Cobalt

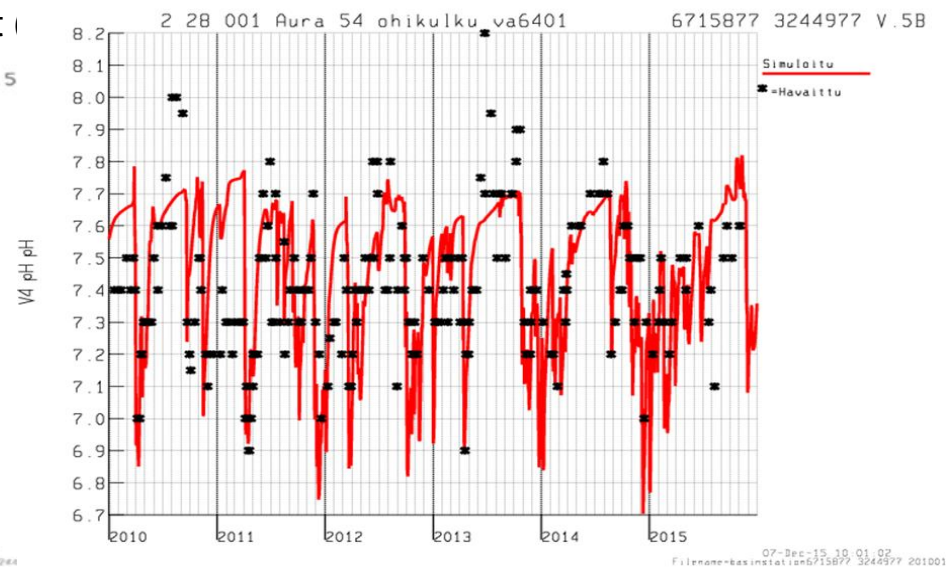
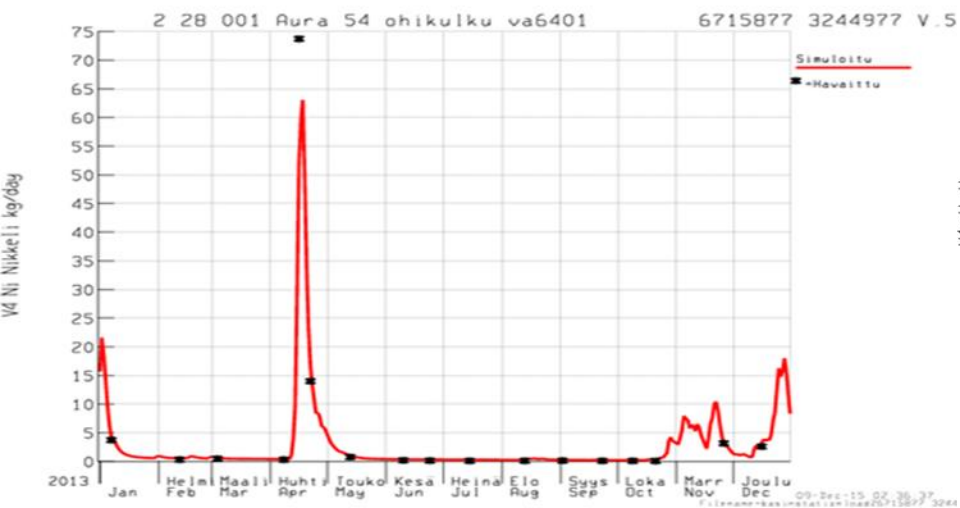

VEMALA

- Water quality model
- Operational over Finnish waters
- It simulates nutrient processes, leaching and transport on land, and in rivers and lakes.
- Simulates from the Finnish water basins to the Baltic Sea:
 - Nutrient gross loading
 - Retention in lakes and in the river network
 - Nutrient net loading
- Nutrient species modelled:
 - Phosphorus: Total phosphorus (TP), phosphate (PO_4^{3-}), organic phosphorus (Porg) and particulate phosphorus (PP)
 - Nitrogen: Total nitrogen (TN), nitrate (NO_3^-), ammonium (NH_4^+) and organic nitrogen (Norg)
 - Suspended solids (SS)
 - Total organic carbon (TOC)
 - Phytoplankton
 - Oxygen (O_2)

Talvivaara 2012 leak: Zn, Ni, Co, Mn, Fe ja U

Etunimi Sukunimi

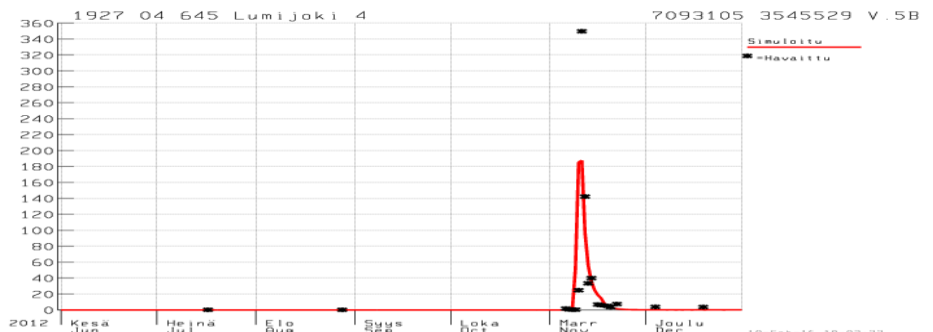
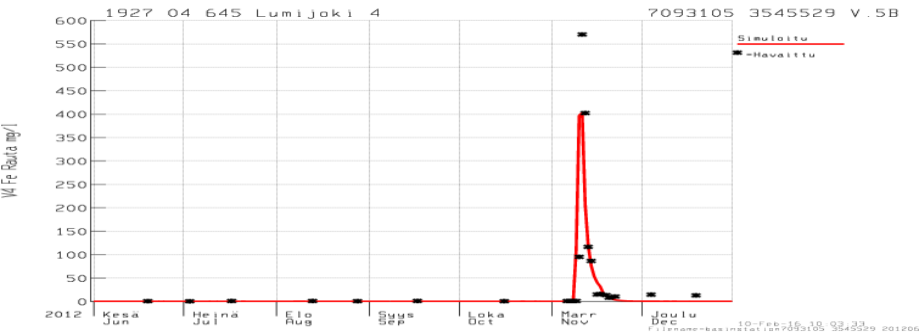
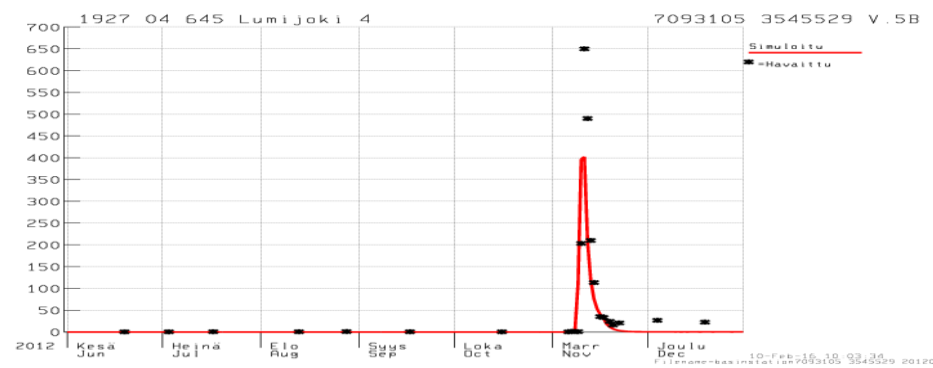
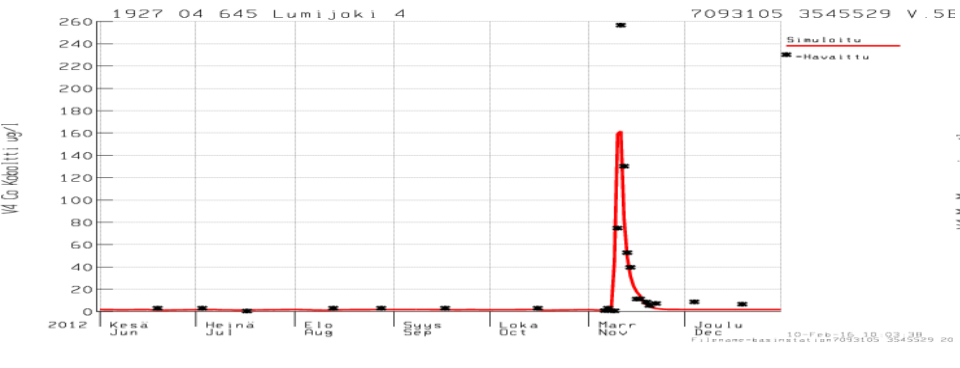
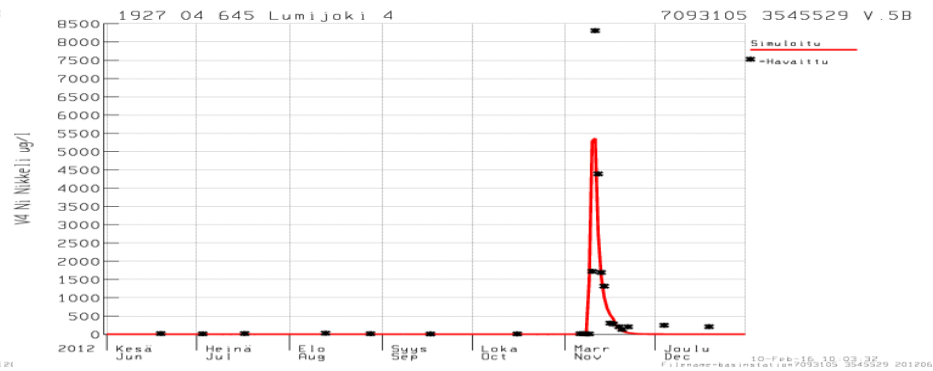
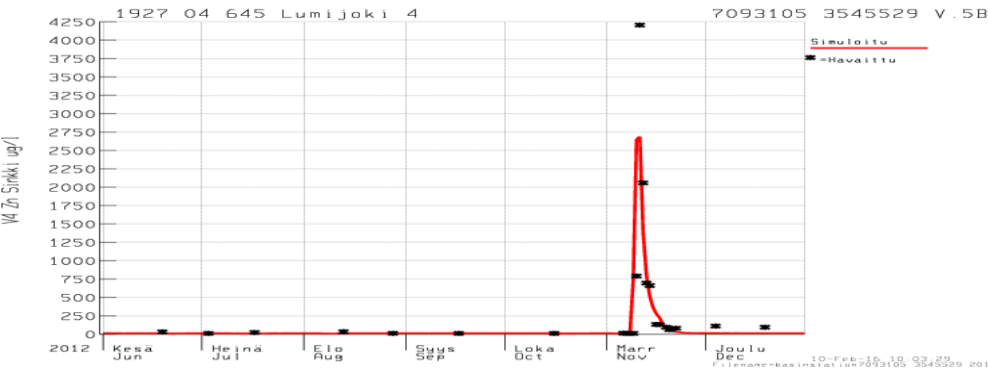

- Daily simulation of 20 hydrological variables (From areal precipitation...to runoff)
 - For each subcatchment (total 6500)
 - For each lake bigger than 1 km²
 - For each day since 1.1.1962 → current day

- Common usages
 - What is the discharge at the end of certain arbitrary area?
 - How has the water equivalent of snow been in certain arbitrary areas in past 20 years? In past 50 years? Past 20 years compared to past 50 years?

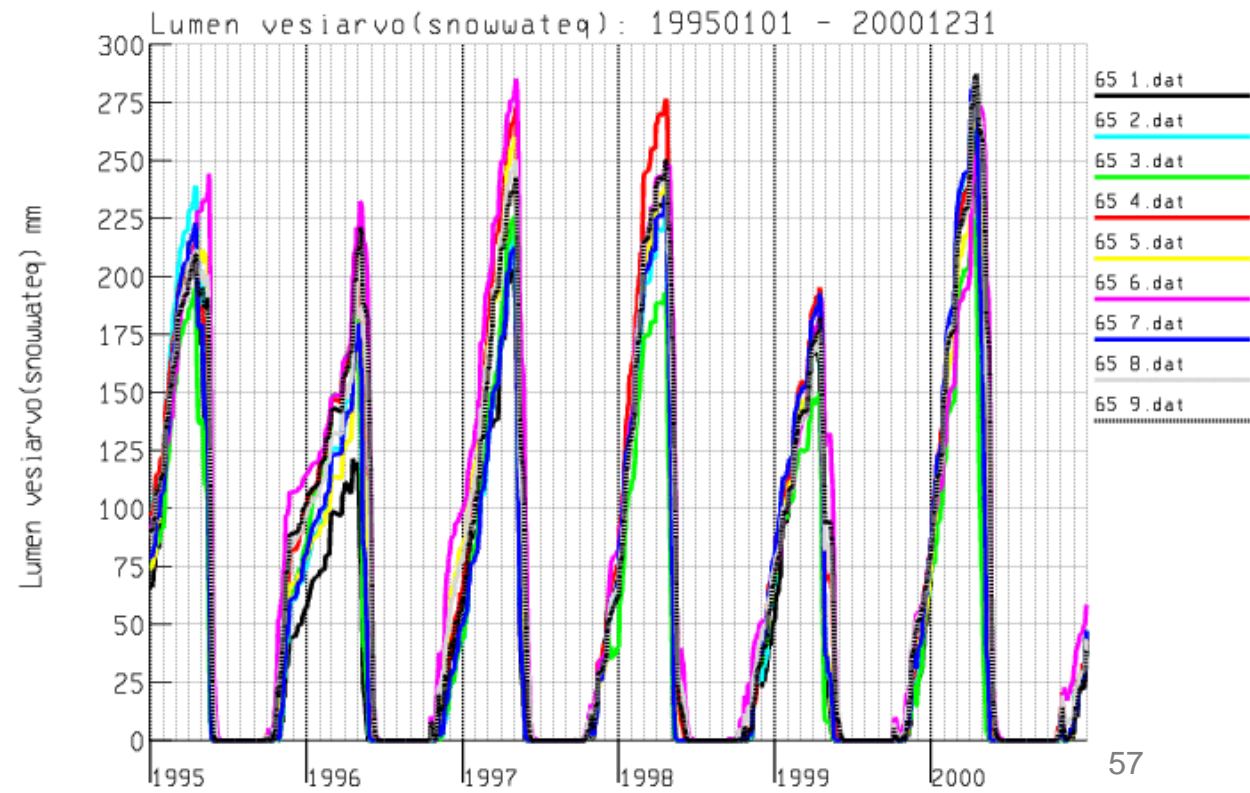

Standardized index

- Compares short-term values with long-term distribution
- Statistical indicator based on a transformation into standard normal variable with zero mean and variance equal to one
- Available for 1, 3, 6, 12 and 24 months periods
- Precipitation (SPI)
 - For meteorological drought situations
- Runoff (SRI)
 - For hydrological drought situations
 - Takes into account, in addition to precipitation, other relevant elements of hydrological cycle
- Both SPI and SRI are "only indicators" of the phenomenon, and it might be wise to use them together instead using just the other

Indicator values	Droughtness	Cumulative probability	Category probability
-1.0 to 0.0	Normal	0.159 – 0.5	34.1 %
-1.5 to -1.0	Moderate	0.067 – 0.159	9.2 %
-2.0 to -1.5	Severe	0.023 – 0.067	4.4 %
$-\infty$ to -2.0	Extreme	0.0 – 0.023	2.3 %

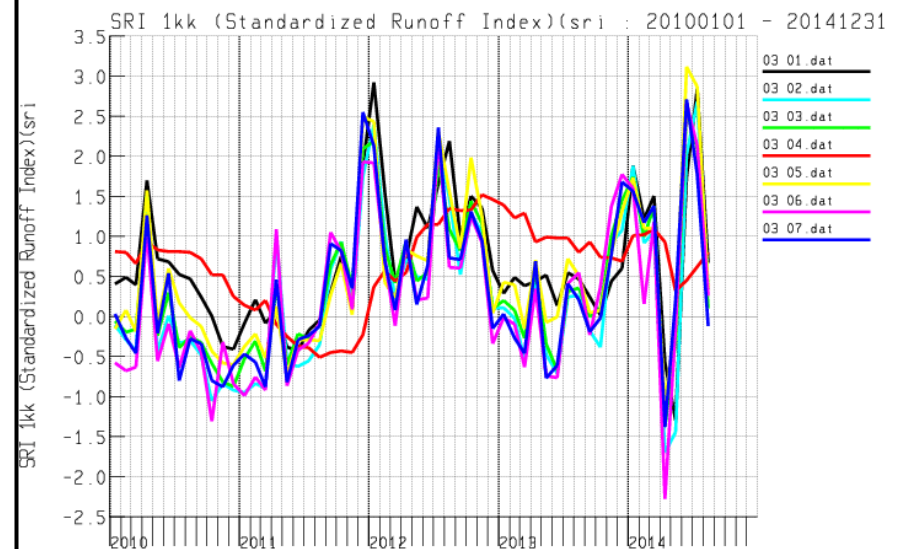
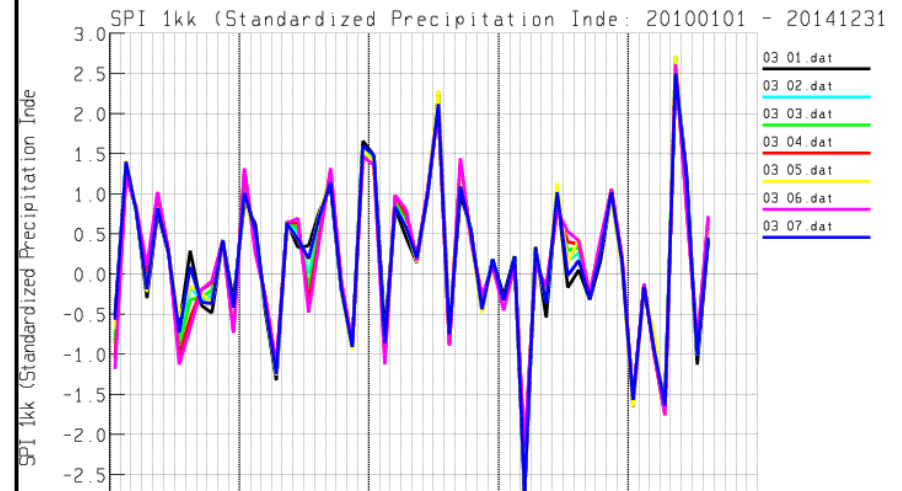

Forecast accuracy monitoring

- WSFS operational model forecast input (precipitation and temperature) and output (lake inflow and river peak flow) is archived and later verified against observations.
- Archiving and verification is completely automatic, and results are shown in continuously updating web interface.
- The web interface shows many verification criteria, tables for comparison, and verification graph types for WSFS forecasting locations in Finland.

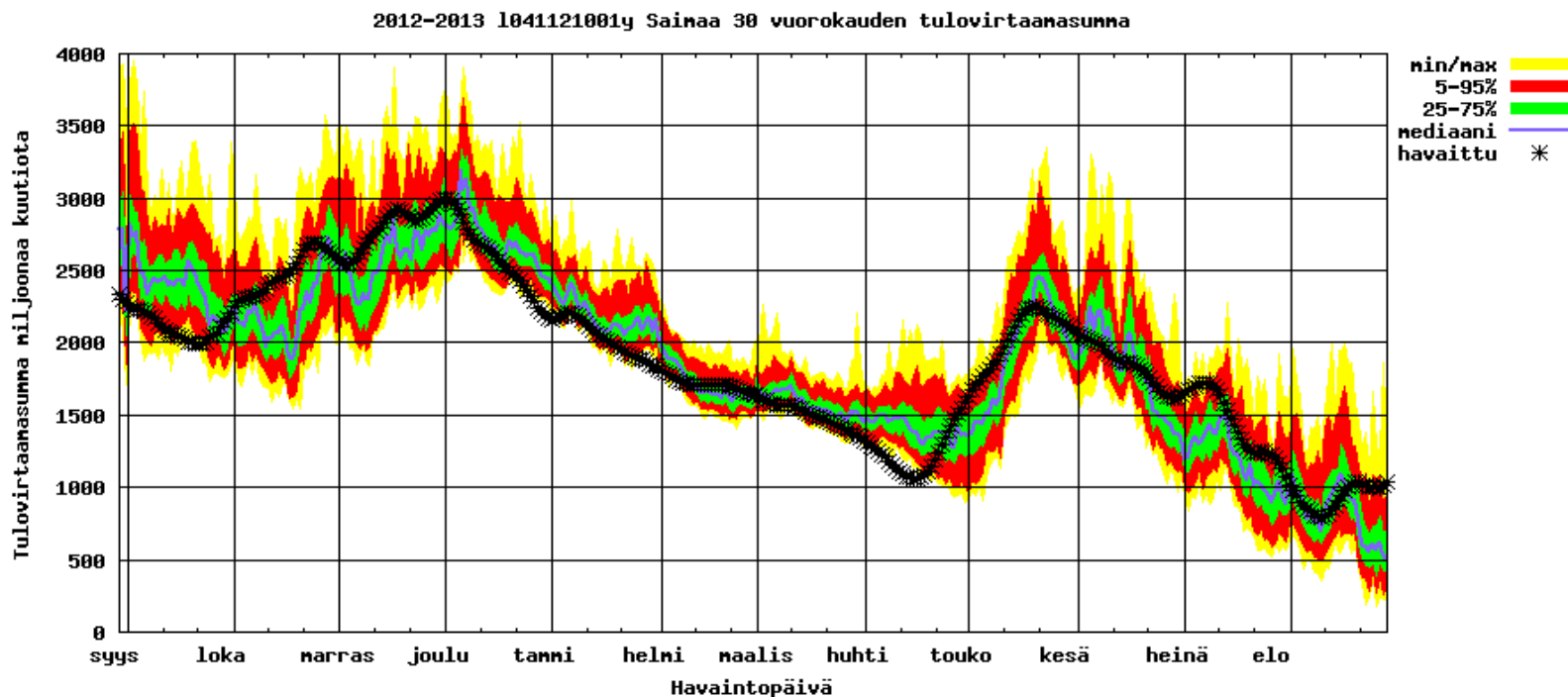

q3509410y Loinijoki, Maurialankoski, virtaahuippu 19.04.2013, 7 vrk aiemmin tehty virtaamaennuste

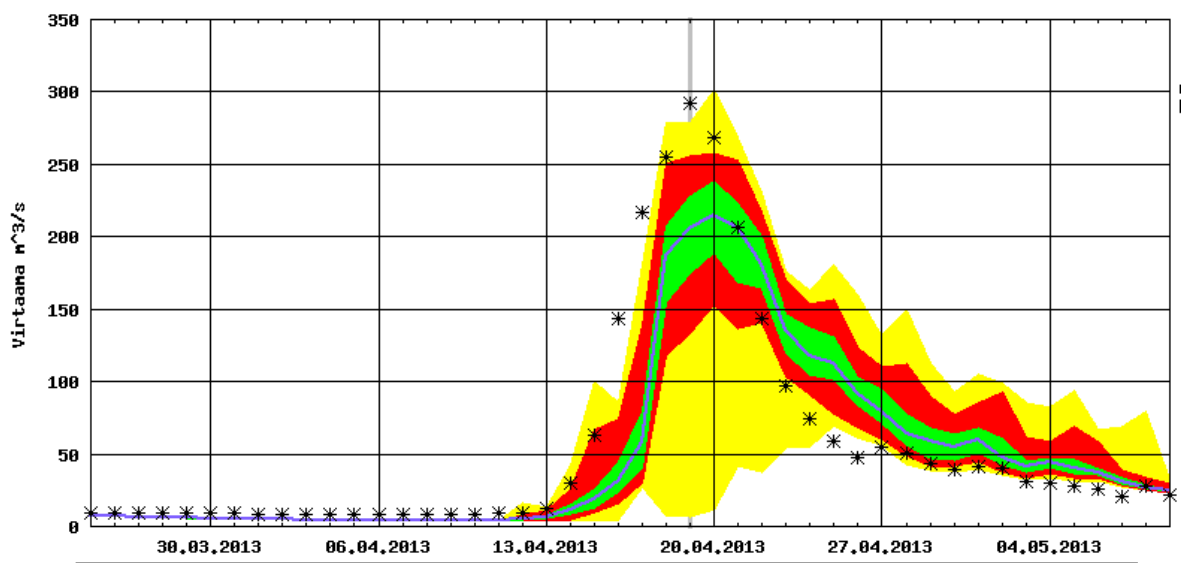

nin/nax ■
 5-95% ■
 25-75% ■
 mediaani —
 havaittu *

Ennustepiste q3509410y, koko valuma-alue. Kaikkien pist...

Taulukossa on virheiden keskiarvot ennusteista, jotka on t...

Huipun pvm	Huippuvirtaama [m³/s]	Huippuvirt. virhe [%]	Ajoitusvirhe [d]
2013-04-19	291.67	15	0.3
2013-01-03	90	37.8	0.4
2012-11-16	86.72	22.1	0.8
2012-10-22	105.69	11.5	1.8
2012-10-06	165.52	41.8	2.9
2012-04-15	104	31.9	2
2012-03-29	170.81	11.5	1.8
2011-12-16	131.39	8.1	0.3
2011-11-28	94.4	28.1	2.1
2011-09-16	65.75	56.3	2.5
2011-04-11	233.76	15.5	1.6
2010-04-06	200.53	5.9	1.1
2009-04-06	166	11.1	3.56
2008-12-02	126.49	10.1	0.7
2008-11-13	154	28.4	0.4
2008-11-01	116.34	11.9	1.9
2008-04-15	128		

Seurattu havainto/ennuste: Oulujärvi (kaikki osat), tulovirtaama (4 vrk ka)

Vuosi	7 vrk				7 vrk				7 vrk			
	Tulovirtaamasumma				Sadesumma				Lämpötilan keskiarvo			
	R²	E [%]	E [Mm³]	N	R²	E [%]	E [mm]	N	R²	E [%]	E [°C]	N
2013	0.77	10	24.31	355	0.66	9	3.88	363	0.98	3	1.14	363
2012	0.85	5	27.33	353	0.43	6	6.56	358	0.97	3	1.30	358
2011	0.58	10	21.84	345	0.57	8	5.42	362	0.97	3	1.24	362
2010	0.35	12	30.24	309	0.37	11	5.15	318	0.98	3	1.46	318
2009	0.83	6	15.70	347	0.51	11	4.39	357	0.97	4	1.23	357
2008	0.83	7	26.67	345	0.35	12	6.32	345	0.94	4	1.41	345
2007	0.44	12	27.01	284	0.33	11	5.01	297	0.95	3	1.42	297
2006	0.80	6	30.07	338	0.54	10	5.39	338	0.94	4	1.85	338
2005	0.70	8	21.51	333	0.18	14	5.71	342	0.95	4	1.56	342
2004	0.45	12	36.45	333	0.24	11	7.30	333	0.96	4	1.38	333
2003	-0.18	16	22.75	153	-3.25	62	16.44	6	0.48	27	2.91	6



Flood Centre

- Joint flood service of Finnish Environment Institute (SYKE) and Finnish Meteorological Institute (FMI)
- National water situation and flood information, forecasts and warnings 24/7
- All types of flooding:
 - Watershed
 - Sea coast
 - Urban
- Solid co-operation with regional flood management authorities (ELY-centres, rescue departments)

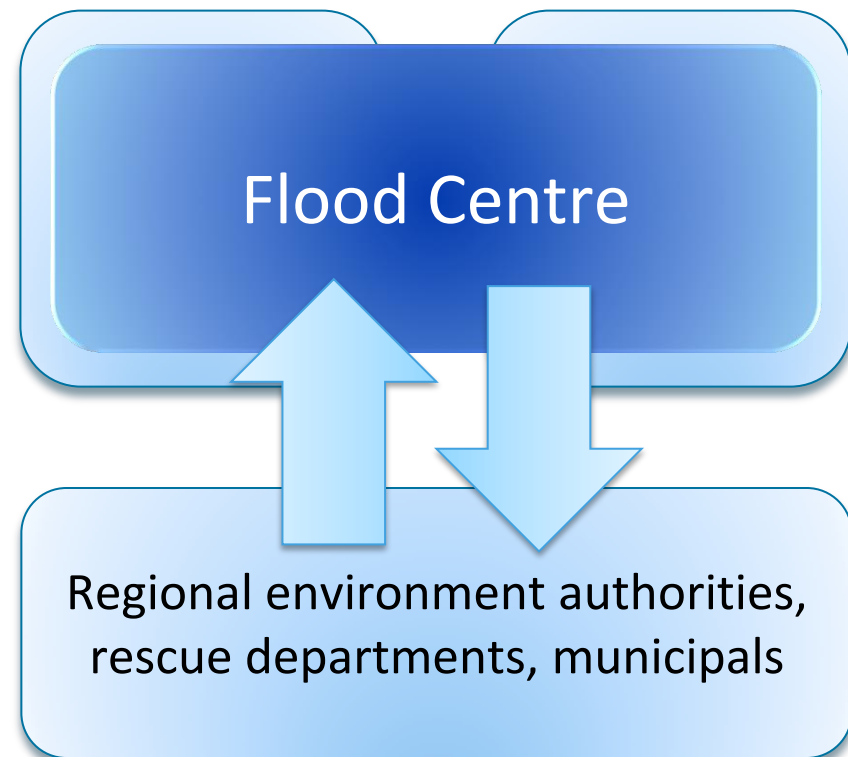

Flood Centre products

- Water situation information
- Flood warnings to authorities and public
- Flood situation picture
- LUOVA (National natural disaster warning and information system) warnings to authorities
- Flood damage and effect forecasts and maps
- Flood expectationality statements to insurance companies

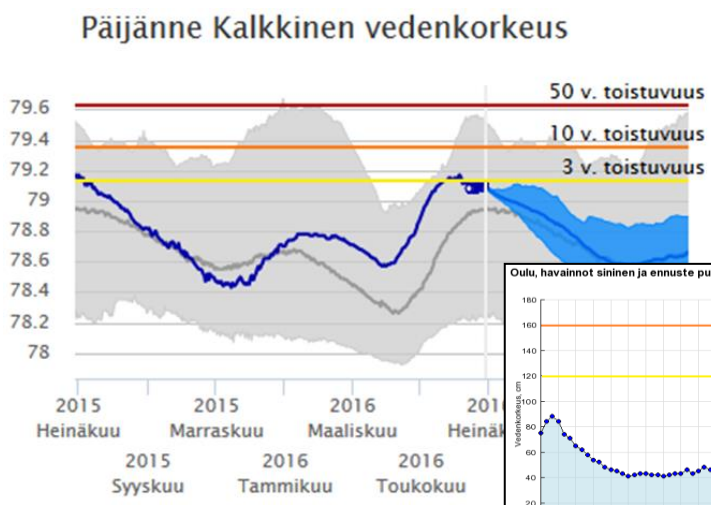
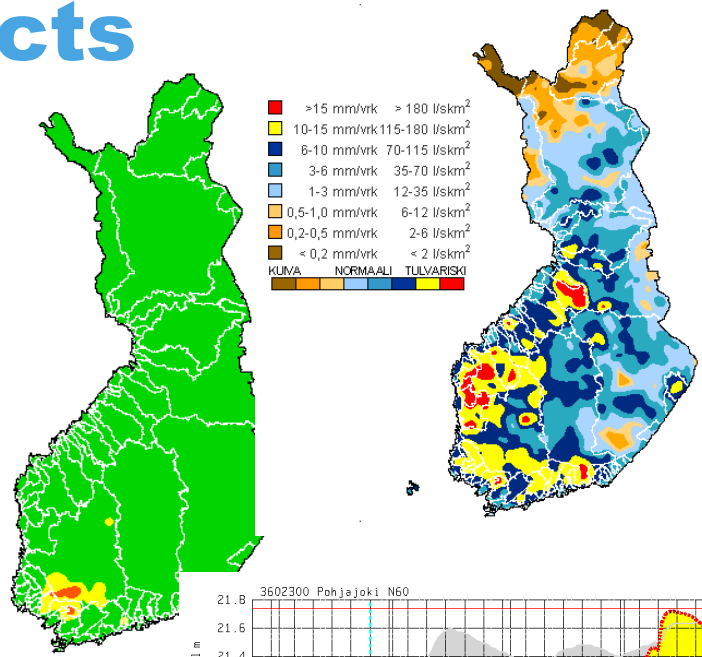

- Hyvin vaarallinen tulva
- Vaarallinen tulva
- Tulva
- Ei tulvaa

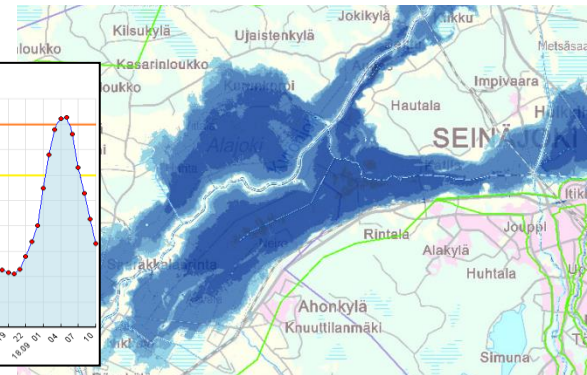
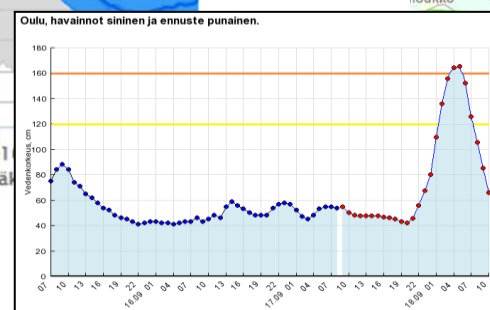
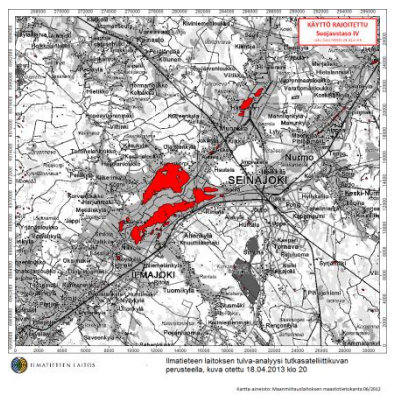
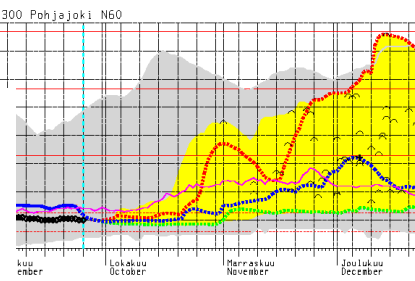

Water situation maps in television broadcast with weather forecast

ohjelmat Suorat Sarjat ja elokuvat Viihde ja kulttuuri Dokumentit ja fakta Uutiset Urheilu Lapset

yle

4.11. JOKIEN VESITILANNE
lähde: Tulvakeskus

tulva / runsasvetinen

normaali

vähävetinen

usteita

6 h jäljellä

Lisää samankaltaista

- Flood map service online
<http://paikkatieto.ymparisto.fi/tulvakartat/html5>
- Flood risk maps show the potential adverse consequences associated with flood scenarios

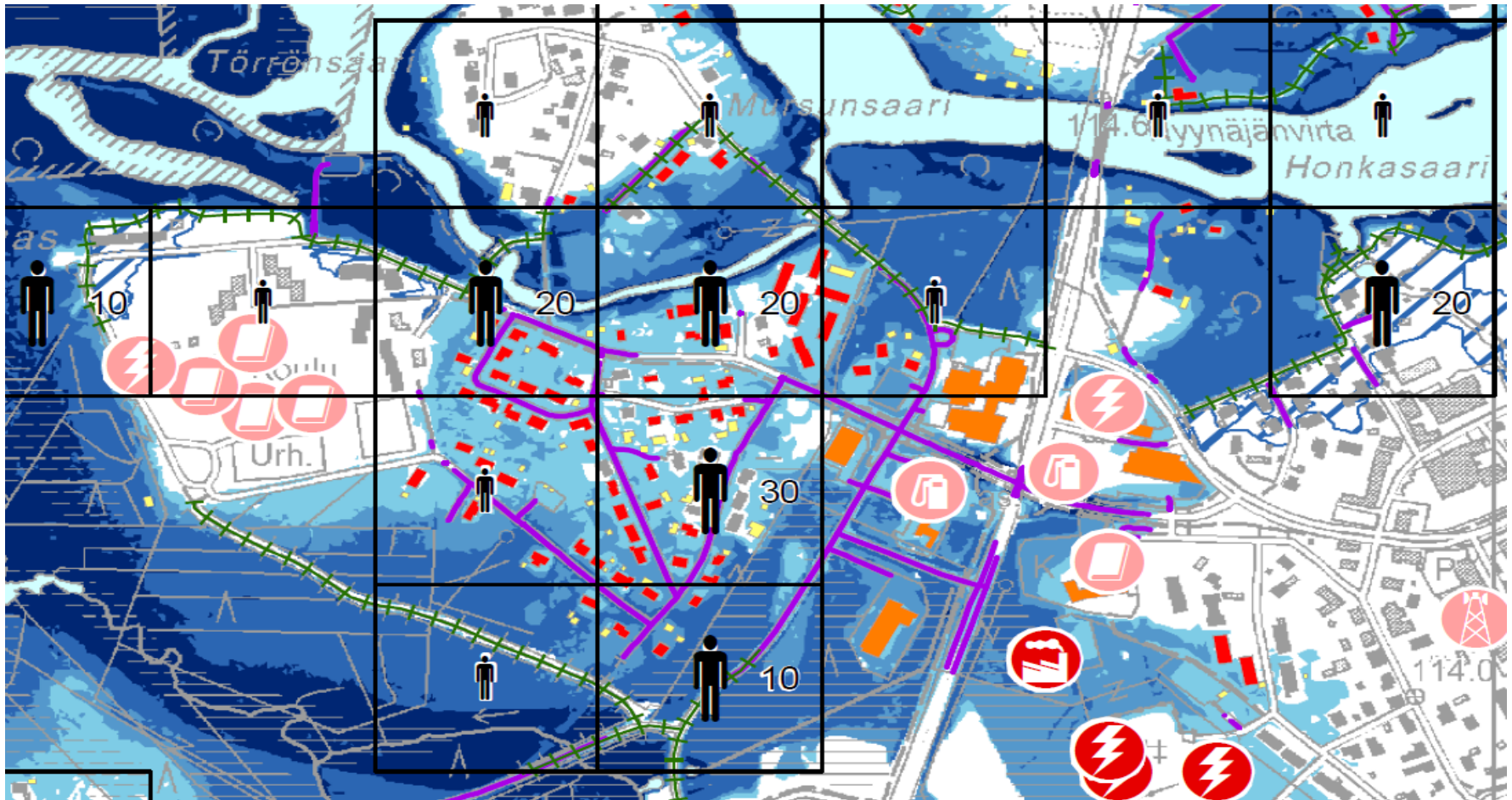

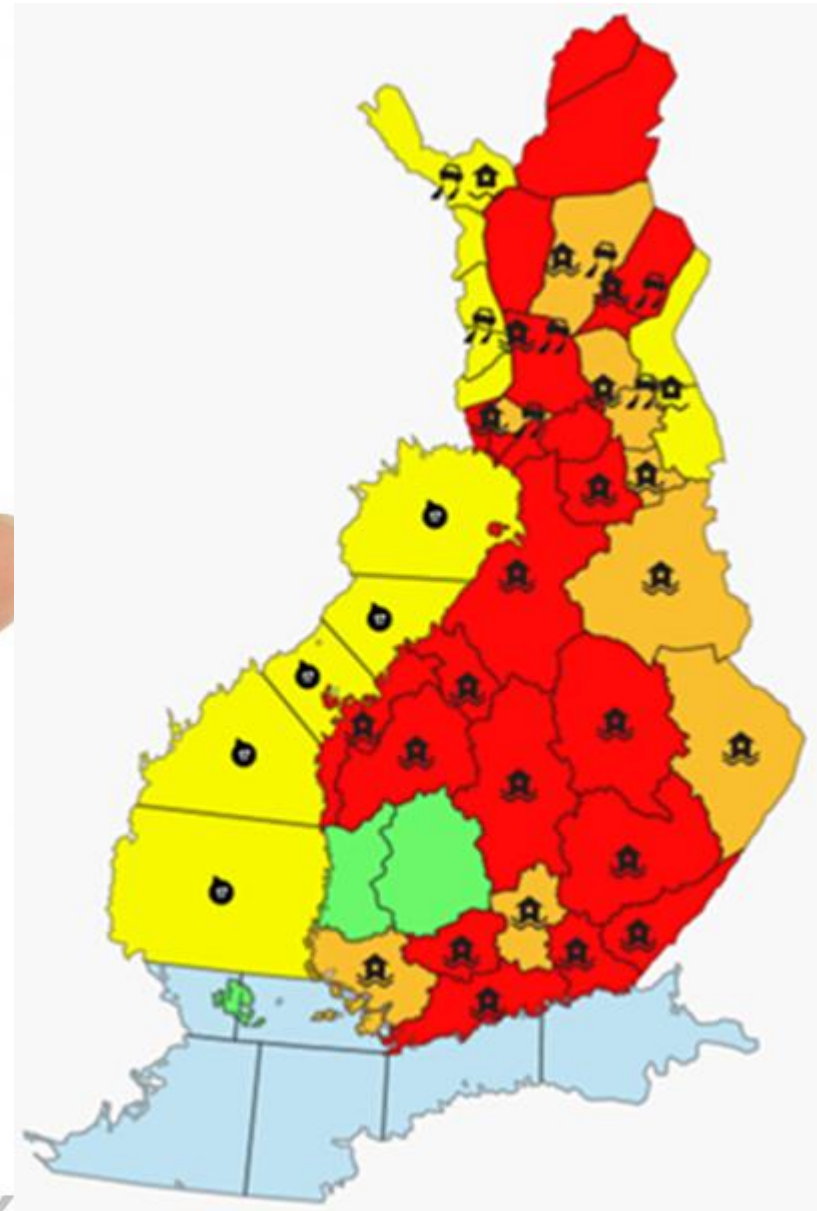

Using COSMO-SkyMed satellite to test flood area mapping on live flood situations

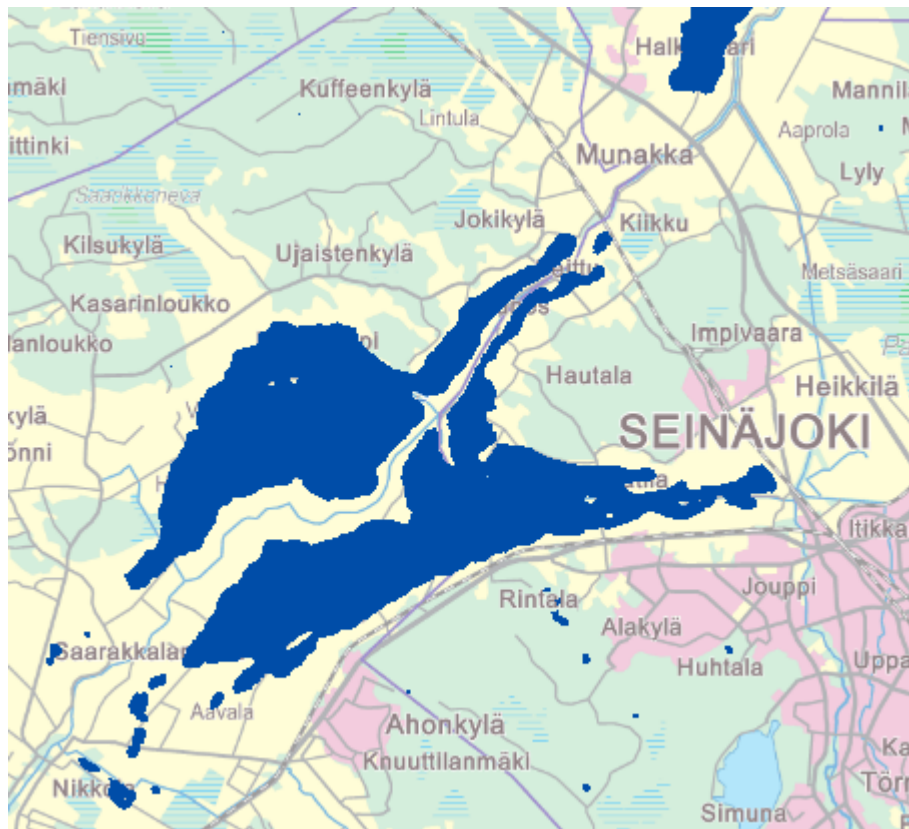

Seinäjoki 23.4.2013 klo 06:45



Kittilä 23.5.2014 klo 05:25

Flood situation meetings

National authorities:

Flood Centre

Ministries

Other possible authorities:

- Lake regulation operators
- Hydropower companies
- Government situation center

Video conferences

- Up-to-date situation picture among all authorities
- Flood forecasts and flood damage forecasts directly from forecasters to end users
- Regional information directly from the flood area
- Custom services (i.e. flood maps from special areas) to regional authorities

Regional authorities at flood area:

Environmental authorities

Rescue departments

Municipals / communities

National flood situation picture (assessment of the situation) – for authorities

- Collects regional and local information and contains information about flood situation, suffered and forecasted flood damages, weather and flood forecast
- Example of flood danger table used in situation picture:

Flood danger level

5%	Very dangerous flood	"Danger to human life and health"
80%	Dangerous flood	"Damages to buildings"
15%	Flood	"Anything which differs flood-wise from normal casual everyday life"
0%	No flood	

Flood Centre operations model

Level of preparedness	Flood service extra actions
Special situation	<p>In addition to raised level actions Flood Centre forms a Special Situation Expert Team</p> <ul style="list-style-type: none">• Status meetings with local flood authorities via video conference whenever needed• On 24/7 alert to help local flood authorities by all means available (e.g. custom made flood risk maps, forecasts and estimates)• Gathers and distributes national flood situation picture• Crisis communications
Raised	<p>In addition to normal level actions:</p> <ul style="list-style-type: none">• Strengthened duty services• Strengthened communications• Secured essential product services• Getting prepared for special situation
Normal	<p>Normal actions:</p> <ul style="list-style-type: none">• Situation monitoring and forecasting• Warnings• Officers on duty co-operation• Daily / bi-weekly status meetings

National water situation online:

<http://www.ymparisto.fi/vesitilanne> (in Finnish)

- Edited, up-to-date information about water situation in Finland
- Flood information during floods
- Written hydrological forecasts for basins
- Overall and detailed versions

6.12.2015

Joet tulvakorkeuksissa Etelä- ja Keski-Pohjanmaalla sekä Lounais-Suomessa (Tulvakeskus 6.12.)

Länsirannikon jokien vedenpinnat ovat paikoin tulvakorkeuksissa sateisen ja lauhan sään johdosta. Lapväärtinjoella, Teuvanjoella, Närpiönjoella ja Maalahdenjoella vesi on noussut tulvakorkeuteen. Vesi on noussut pelloille Loimijoella ja Lapuanjoen Liinamaassa. Tälle päivälle ennustetut sateet kasvattavat jokien virtaamia vielä paikoin Etelä- ja Keski-Pohjanmaalla ja Lounais-Suomessa. Sateiden vaikutukset ulottuvat myös Etelä- ja Itä-Suomen vesistöihin nostaten jokien vedenkorkeuksia. Vesi nousee jokiuomissa paikoin vastaamaan keskimääräistä tulvaa Etelä- ja Keski-Pohjanmaalla sekä Lounais-Suomessa. [Lisää](#)

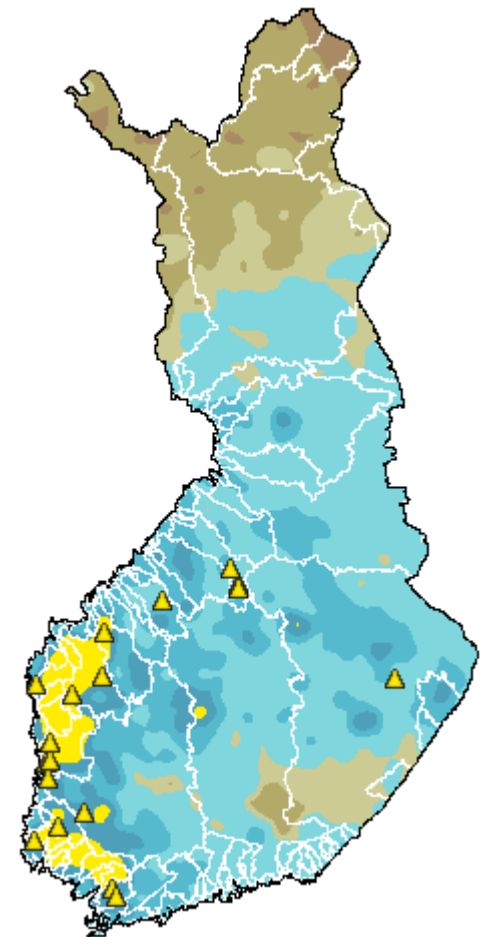
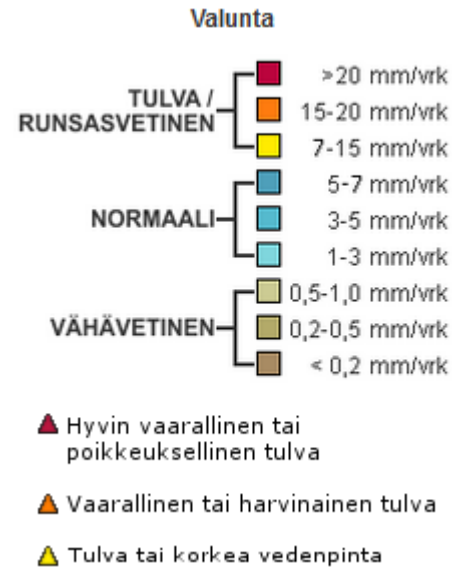

SYKEN hydrologit uudelleentwiittasi

ELY Tulvatpohjanmaa @tulvatpohjanmaa · 14 t

#Närpiönjoki 'en virtaaman nousu näyttää tasaantuneen tasolle 107 m3/s ja aurinko paistaa joen alaosalla [#elykeskus](#)

Vesitilanne ja ennuste 7.2.2014

Tulvakeskuksen vesitilanne ja ennuste 7.- 12.2.2014

Laadittu 7.2.2014

LAATIJAT

Tulvapäivystäjä Juho Jakkila

LUOVA-päivystäjä Helena Laakso/Paavo Korpela

Meripäivystäjä -

VAARATASOJEN TODENNÄKÖISYYDET

[0%] Hyvin vaarallinen tulva

[0%] Vaarallinen tulva

[5%] Tulva

[95%] Ei tulvaa

VESISTÖJEN TILANNE TIIVISTETYSTI

Viikonloppuna lauhtuva sää ja vesisateet lisäävät valuntaa ja rannikkoalueiden pienten jokien virtaamia Etelä- ja Lounais-Suomessa. Rannikkoalueiden lumimäärät ja viikonlopuksi ennustetut sateet eivät kuitenkaan nosta jokien vedenkorkeuksia tulvalukemiin. Mikäli sää jatkuu leutona ja sateisena voi tilanne muuttua ensi viikon aikana.

ARVIOT VAHINGOISTA

Todennäköisesti ei uusia vahinkoja.

EPÄVARMUUSTEKIJÖITÄ

Lauhtuva keli saattaa irrottaa jokien suppokasaumia ja synnyttää uusia jääpatoja, mikä voi aiheuttaa paikallista tulvimista. Tämä ei kuitenkaan ole kovin todennäköistä.

SÄÄ- ja RANKKASADETILANNE TIIVISTETYSTI

Suomessa vallitsee viikonlopun ajan lauha etelänpuoleinen ilmavirtaus. Lauantaina lumisadealue liikkuu Suomen yli. Lounaassa sataa myös räntää, ehkä vettäkin. Sadetta kertyy vedeksi muutettuna 2-10 mm, Pohjois-Lapissa 0-2 mm. Sunnuntaina alkuviikolla tulee paikoin vähäisiä lumitai jäätäviä tihkusateita.

MERIVESITILANNE TIIVISTETYSTI

Ennustejakson aikana ei ole odotettavissa merivesitulvia.

Vesitilanne ja ennuste 29.11.2015

Tulvakeskuksen vesitilanne viranomaisille
29.11. - 1.12.2015

LAATIJAT

Tulvapäivystäjä Tiia Vento

Meripäivystäjä -

Luova-päivystäjä Hannu Valta

LAATIJAT

Tulvapäivystäjä Tiia Vento

VAARATASOJEN TODENNÄKÖISYYDET

Vesistötulvat:

[0 %] Hyvin vaarallinen tulva

[2 %] Vaarallinen tulva

[78 %] Tulva: Pohjanmaa, Etelä-Pohjanmaa

[20 %] Ei tulvaa

VESISTÖJEN TILANNE TIIVISTETYSTI

Sateinen ja lauha sää on kasvattanut virtaamia etenkin Pohjanmaan alueella tällä viikolla. Vaasan eteläpuolisissa pienissä vesistöissä jokien pinnat ovat nousseet korkealle yön ja aamun aikana. Matalapaine tuo lisää sateita Pohjanmaan alueelle ja sadekertymä lähipäiville on ennusteen mukaan 20-30 mm. Jos sateet tulevat vetenä ne nostavat virtaamia nopeasti sillä maaperä on märkää. Vesi voi nousta alaville pelloille ja myös tulviminen paikallisteille on mahdollista.

MERIVESITILANNE TIIVISTETYSTI

Tuulista johtuen merenpinta on viikonvaihteessa paikoin korkealla eritoten Saaristomerellä ja Pohjanlandella.

RANKKASADETILANNE TIIVISTETYSTI

Rankkasateiden todennäköisyys on vähäinen.

Climate change and hydrology

- Effects of climate change on hydrology
 - Floods and droughts
 - Regulation planning
 - Groundwater level
 - Water quality
- Adaptation to climate change impacts
 - Changes in lake regulation
 - Flood risk management

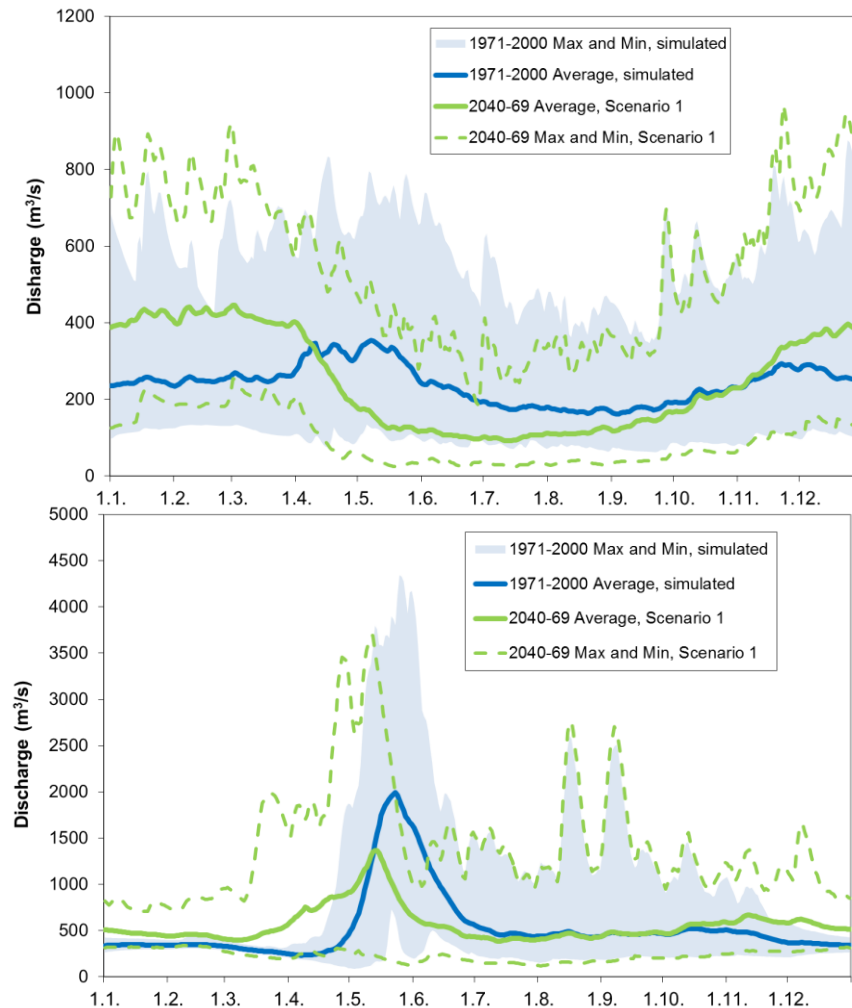

Climate change: methods

- Global and regional climate scenarios
 - European meteorological institutes, ENSEMBLES project
 - European Rossby Centre: RCA3
 - Max-Planck Institute: Echam, REMO
 - Danish Meteorological Institute: HIRHAM
 - METEO-FRANCE: ARPEGE
 - Bergen climate model: BCM
 - The National Center for Atmospheric Research (US): NCAR
 - SRES-scenarios a2, a1b and b1
- Delta change and Bias correction methods
- Co-operation with FMI
- In the future CMIP5

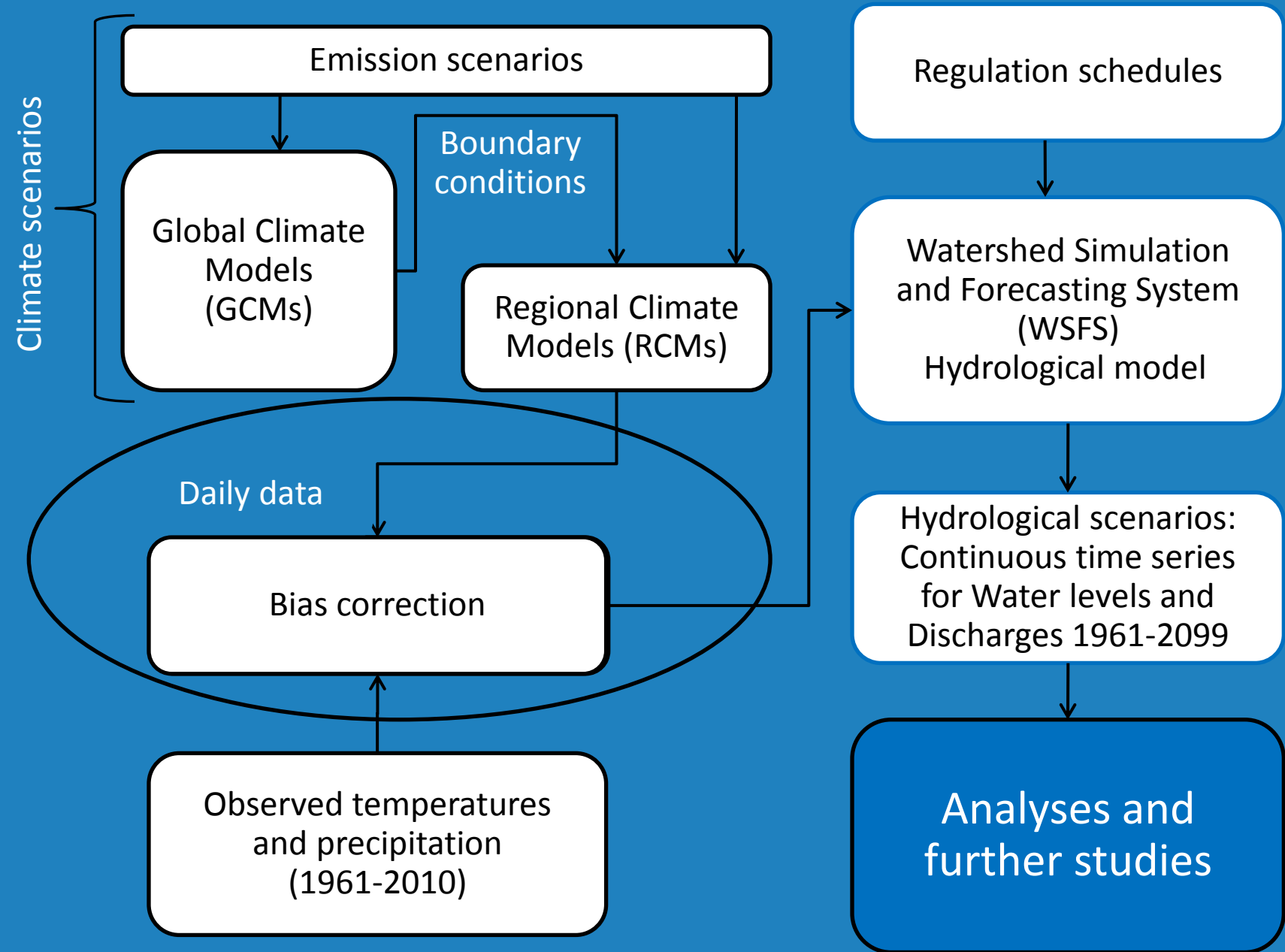

Comparison of the results with delta-change and bias correction methods

- Differences between delta-change and q-q-mapping studied with 4 scenarios in 4 test sites
- Similar results in mean discharges with different methods
- Different changes e.g. in spring in Northern Finland
- Bias correction is expected to improve the estimation of the changes in summer and autumn floods

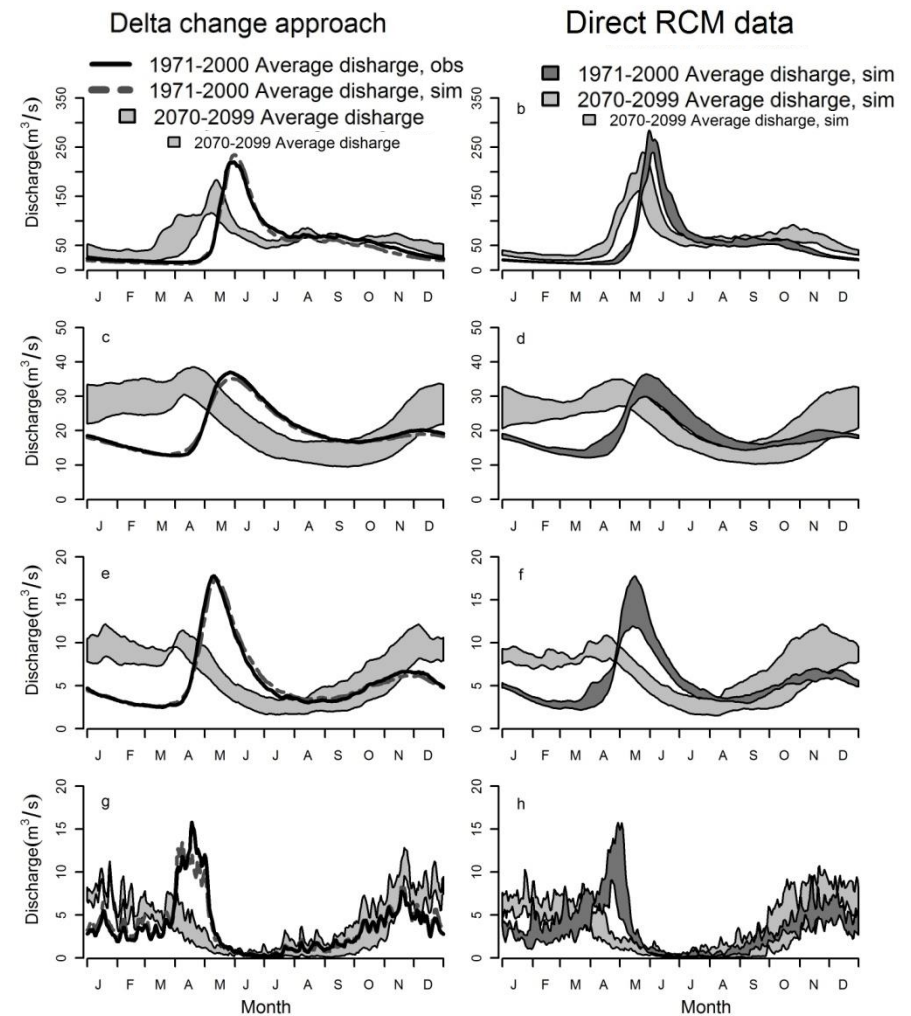

WSFS can be used for planning and rehearsal purposes

- Estimation of design floods for dams
- Tailored made scenarios and forecasts for major flood rehearsals

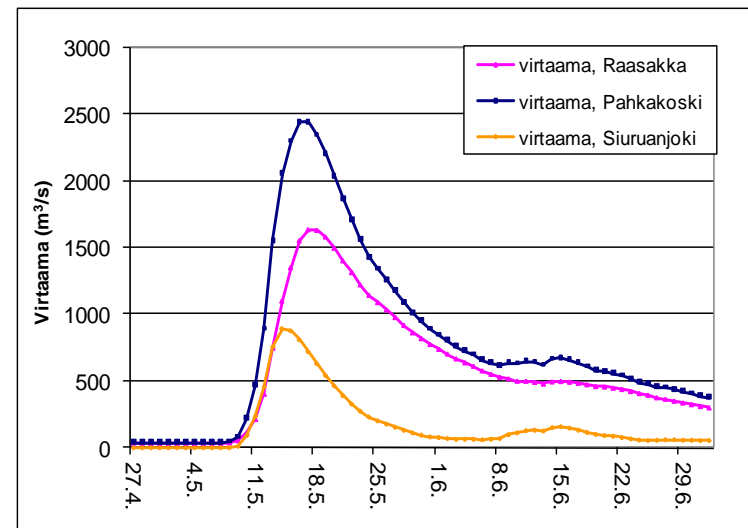
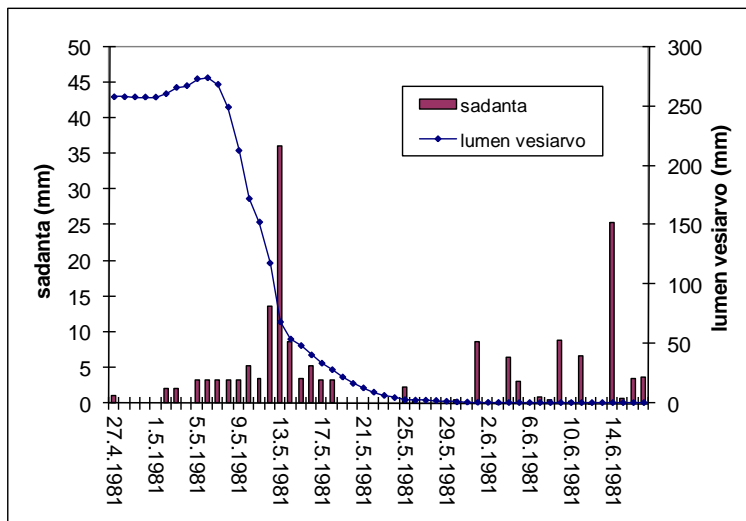
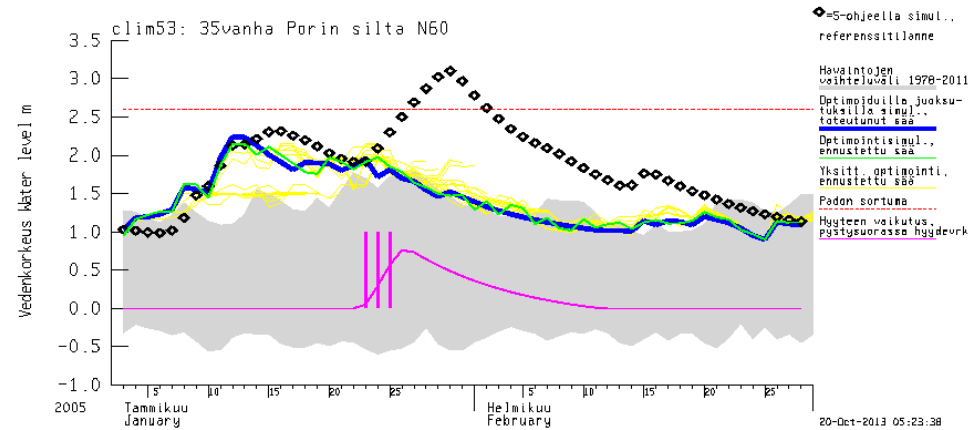

- Water quality process model development

Nitrate leaching model

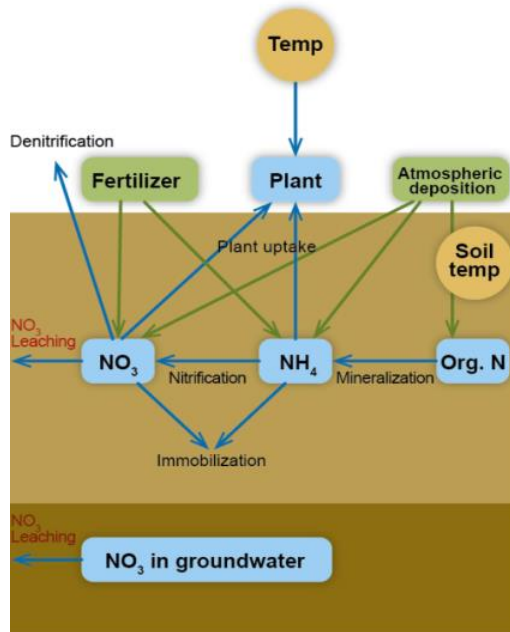

Conceptual hydrological model

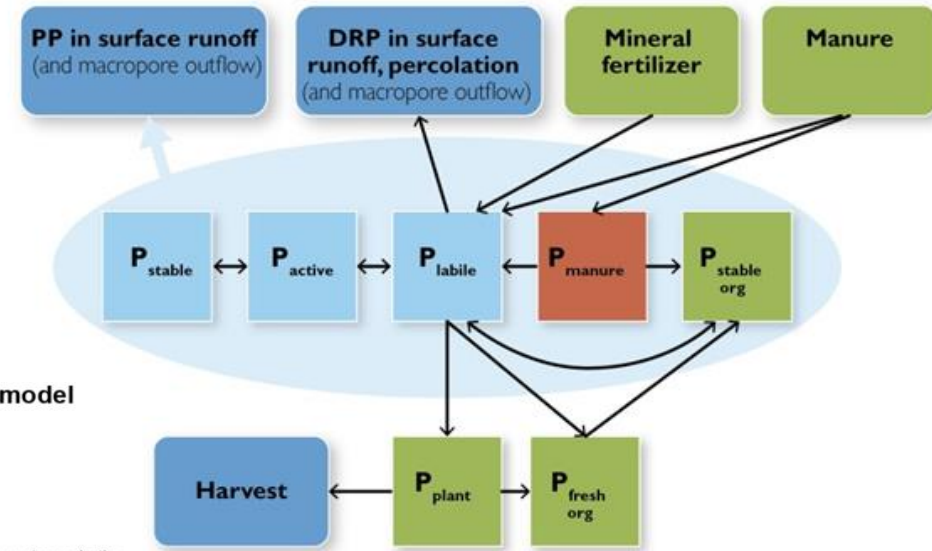
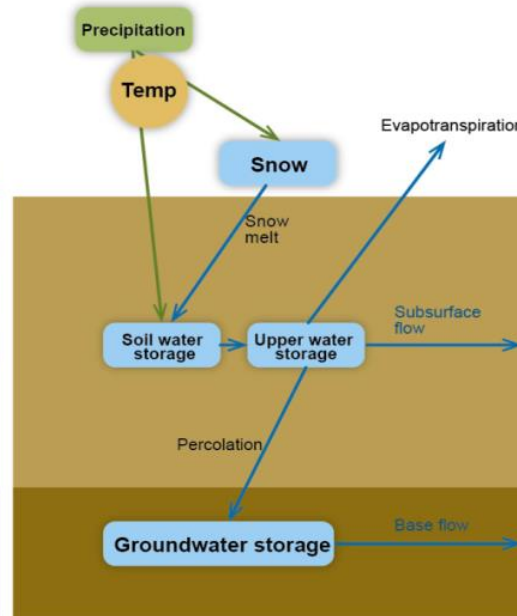

Simulated daily NO_3^- concentration and load

- Example: Aurajoki watershed (874 km²): cultivated land 37 %, from which 47 % is clay
- Simulated NO_3^- concentration
- Simulated NO_3^- load

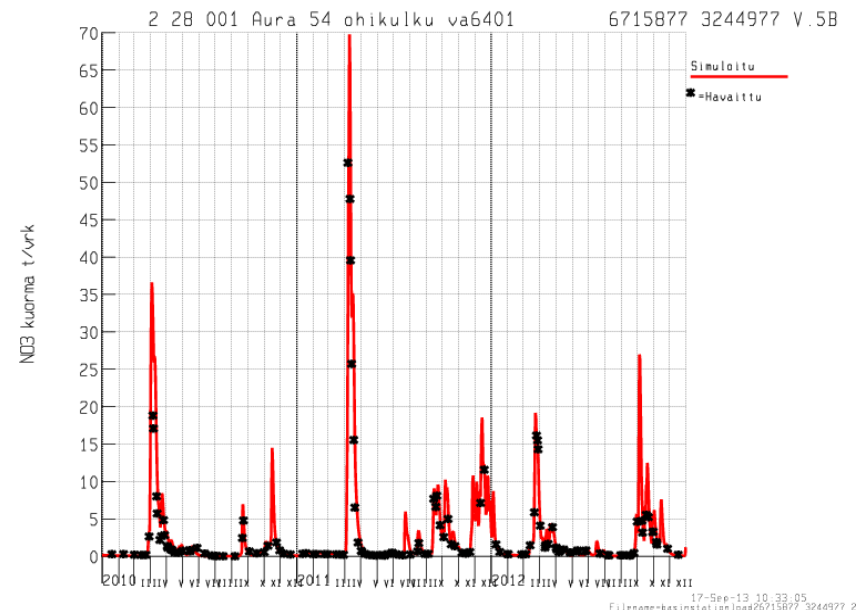
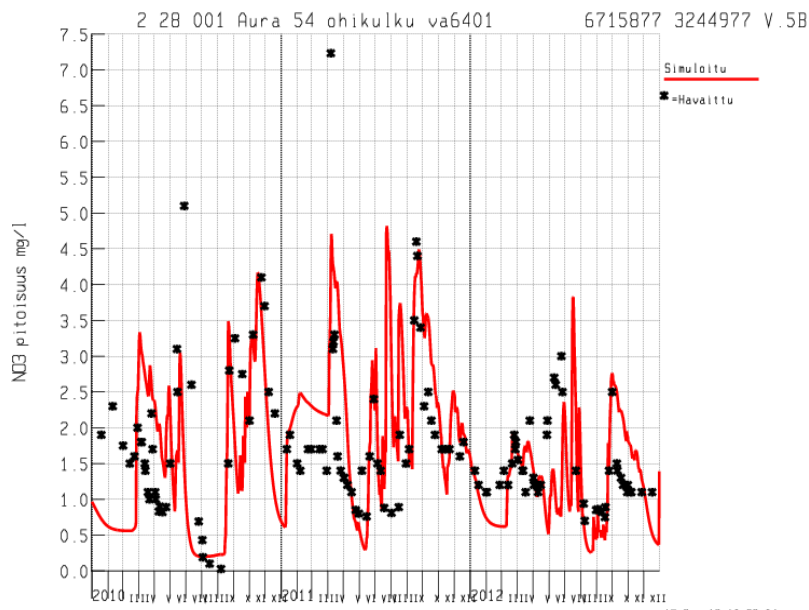
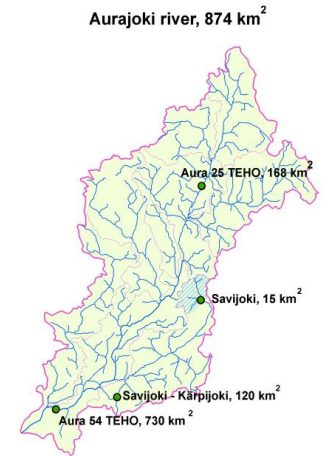

Model can be used to simulate effect of changing crop and fertilization on the nitrate leaching

- Nitrate leaching is the highest for root crops, then spring cereals, grasslands, winter cereals and the least from green fallow

- Amount of fertilizer use and precipitation effects the amount of nitrate leaching

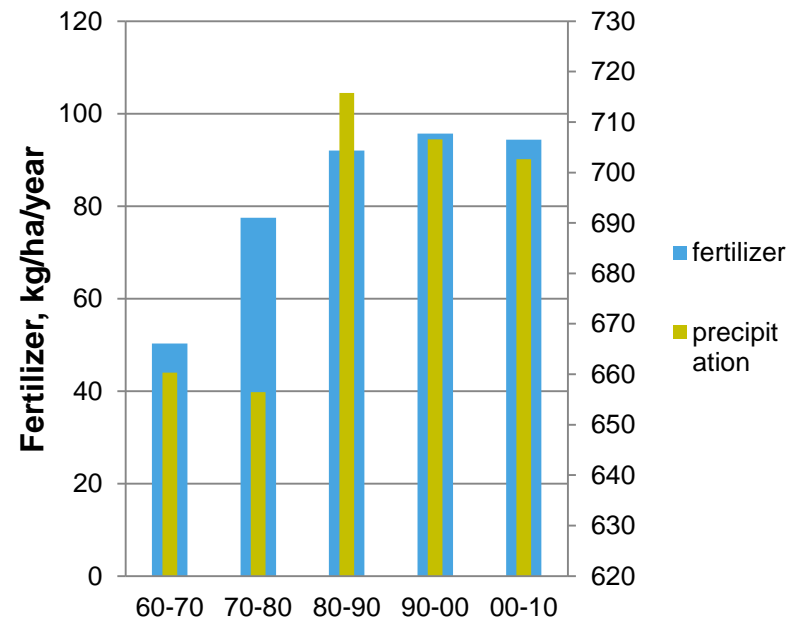
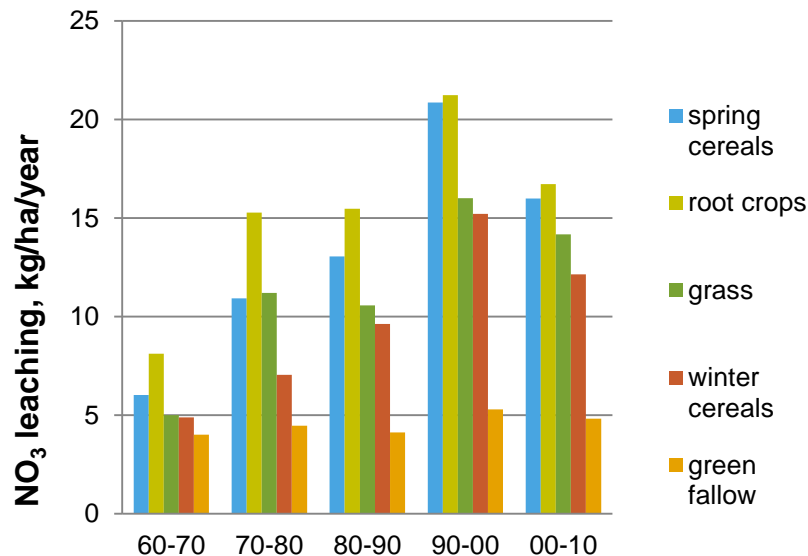

Daily biomass growth based on global radiation (Karvonen and Varis, 1992)

$$G = 10 * E_{rad} * f_{LAI} * 0.48 * R_s * MIN(f_W, f_N, f_P, f_T)$$

$$f_{LAI} = (1 - e^{-k_E LAI})$$

G – daily biomass growth, kg Dry Matter/ha/day

R_s - global short wave radiation MJ/m²/day,

E_{rad} - light use efficiency LUE constant (crop specific), g dry matter/MJ, clover 1.6, spring wheat 1.4-1.8, LUE depends on CO₂ concentration in atmosphere

0.48 – fraction of PAR (photosynthetically active radiation) from total daily global radiation,

f_{LAI} - the effect of incomplete canopy

k_E - radiation attenuation by plants (0.6...0.7)

f_w – soil moisture effect on photosynthesis, f_N - N shortage coefficient, f_P - P shortage coefficient, f_T – temperature effect coefficient

MIN is searching for the limiting factor of the 4 above mentioned factors.

Simulated short wave radiation, max observed at Jokionen around 30 MJ/m²/day

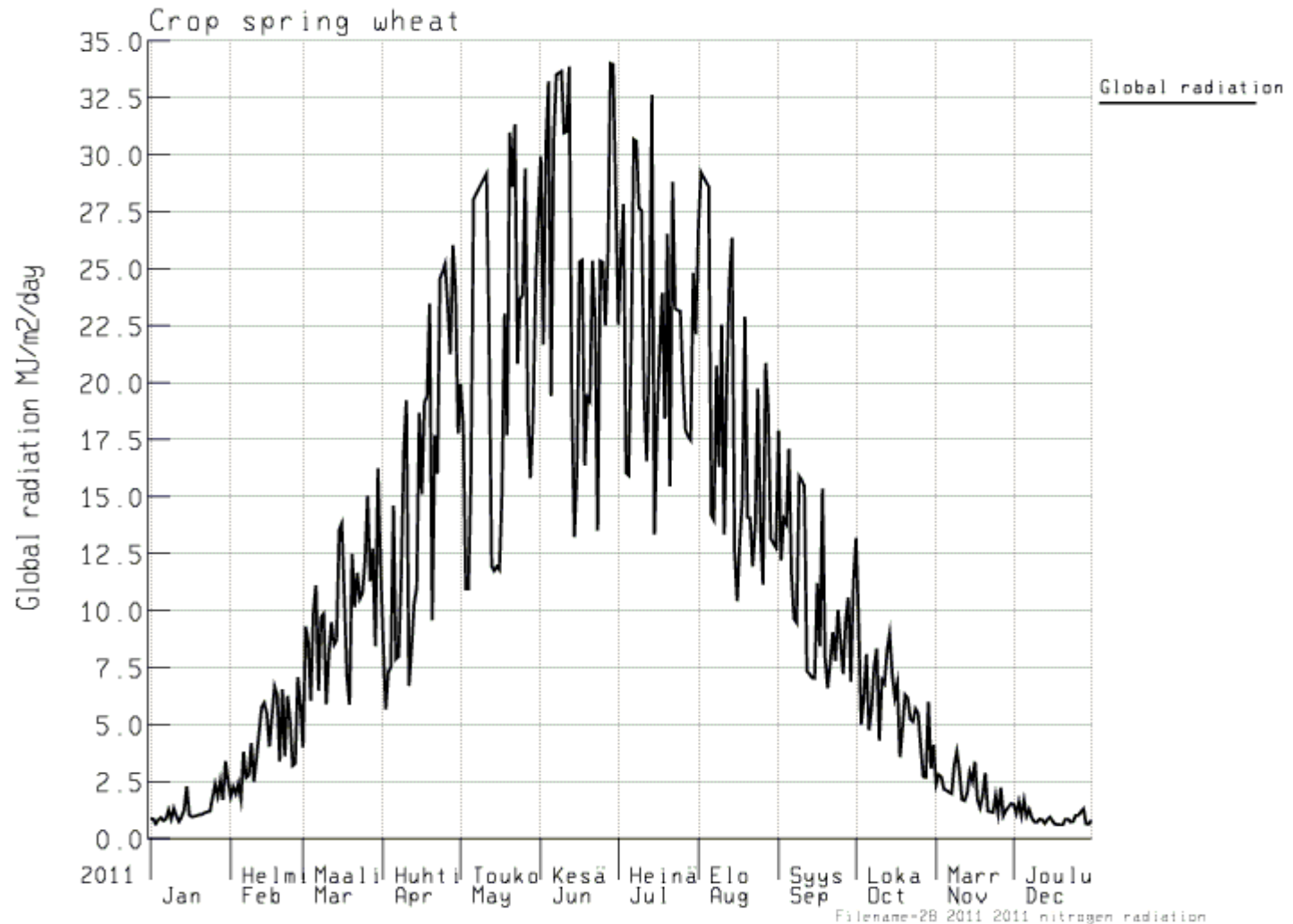

Simulated daily N uptake for spring and winter cereals

- Spring cereals –
N uptake 110 kg/ha,
biomass 7828 kg/ha
- Winter cereals –
N uptake 139 kg/ha,
biomass 9205 kg/ha
- Winter cereals start to grow in autumn and faster is taking nutrients up in spring

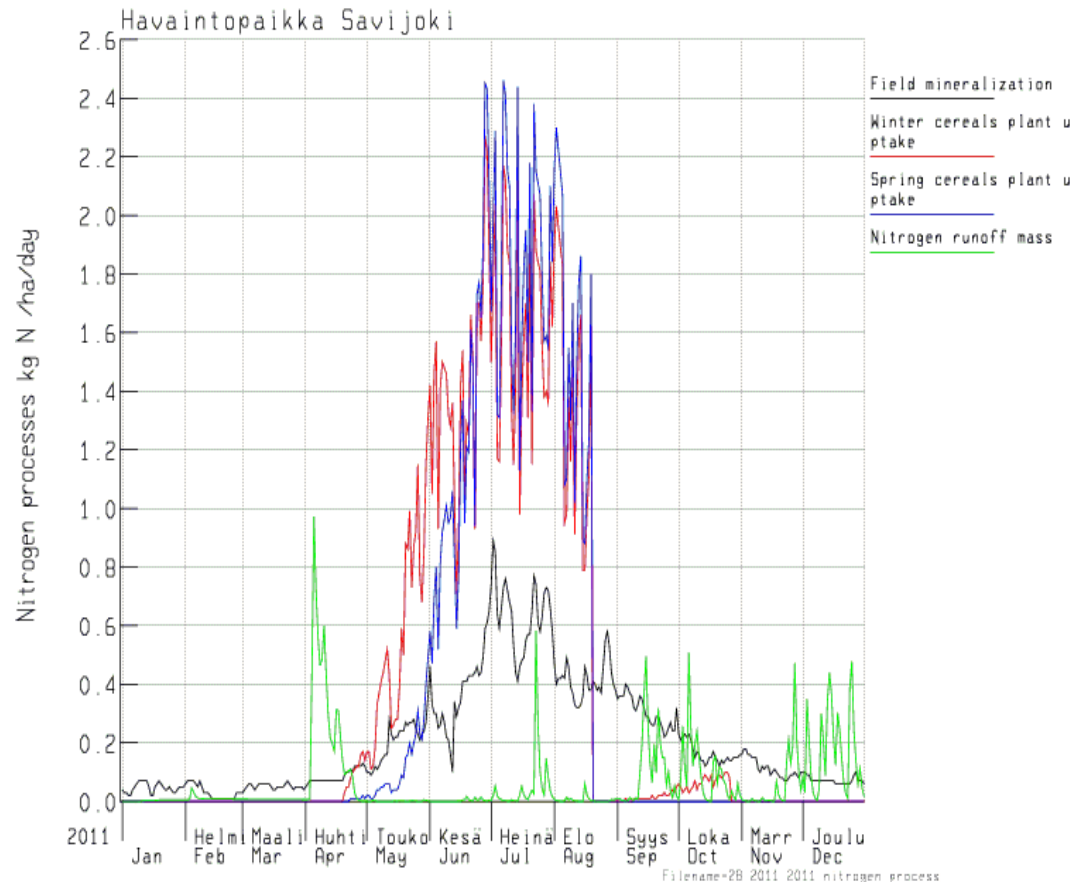

Annual spring cereal yields (VAR-ely) and simulated biomass (Aurajoki)

- Annual spring cereal yields are increasing during the last two decades
- Model can well simulate the effect of dry years on the biomass development (1992, 1999)

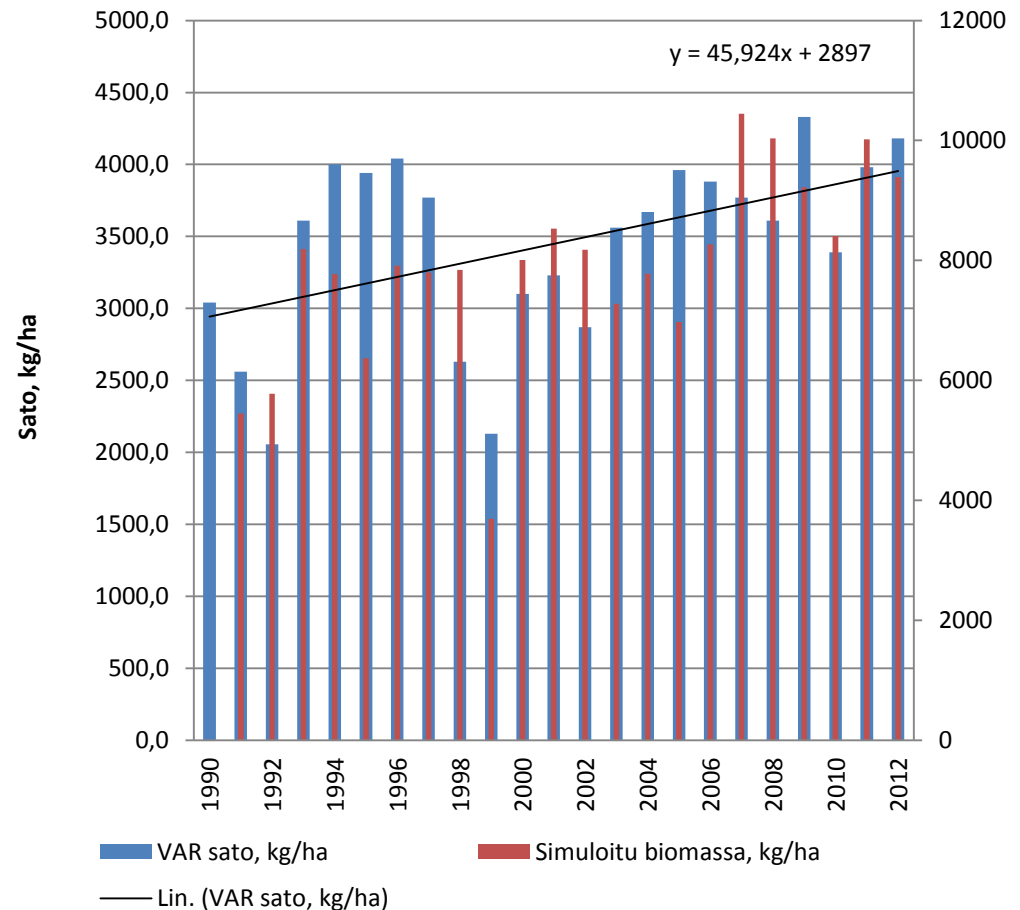

Use of the biomass growth model

- Biomass growth model is used in simulating N demand/uptake
- Biomass growth model simulates Leaf area index (LAI) and it can be used in actual evapotranspiration model development

Introduction

- The VEMALA model is developed towards a more process-based model where the same processes are applied in lakes and rivers but the conditions change (water velocity, depth and mixing)
- The variables included in the future VEMALA model are:
 - Nitrogen (Norg, NO₃, NH₄)
 - Phosphorus (PP, PO₄)
 - Phytoplankton (2 different species)
 - Oxygen
- The modeling of these variables requires the development of:
 - Sediment processes for the nutrient cycling
 - Lake stratification for the nutrients and oxygen cycling

Phytoplankton model based on the **AQUAPHY** model (Lancelot et al., 1991)

- Interaction of nutrients and phytoplankton:
 - Nutrient uptake of dissolved nutrients (NO_3 , NH_4 & PO_4)
 - Sedimentation and lysis provide organic nutrients (Norg and PP)

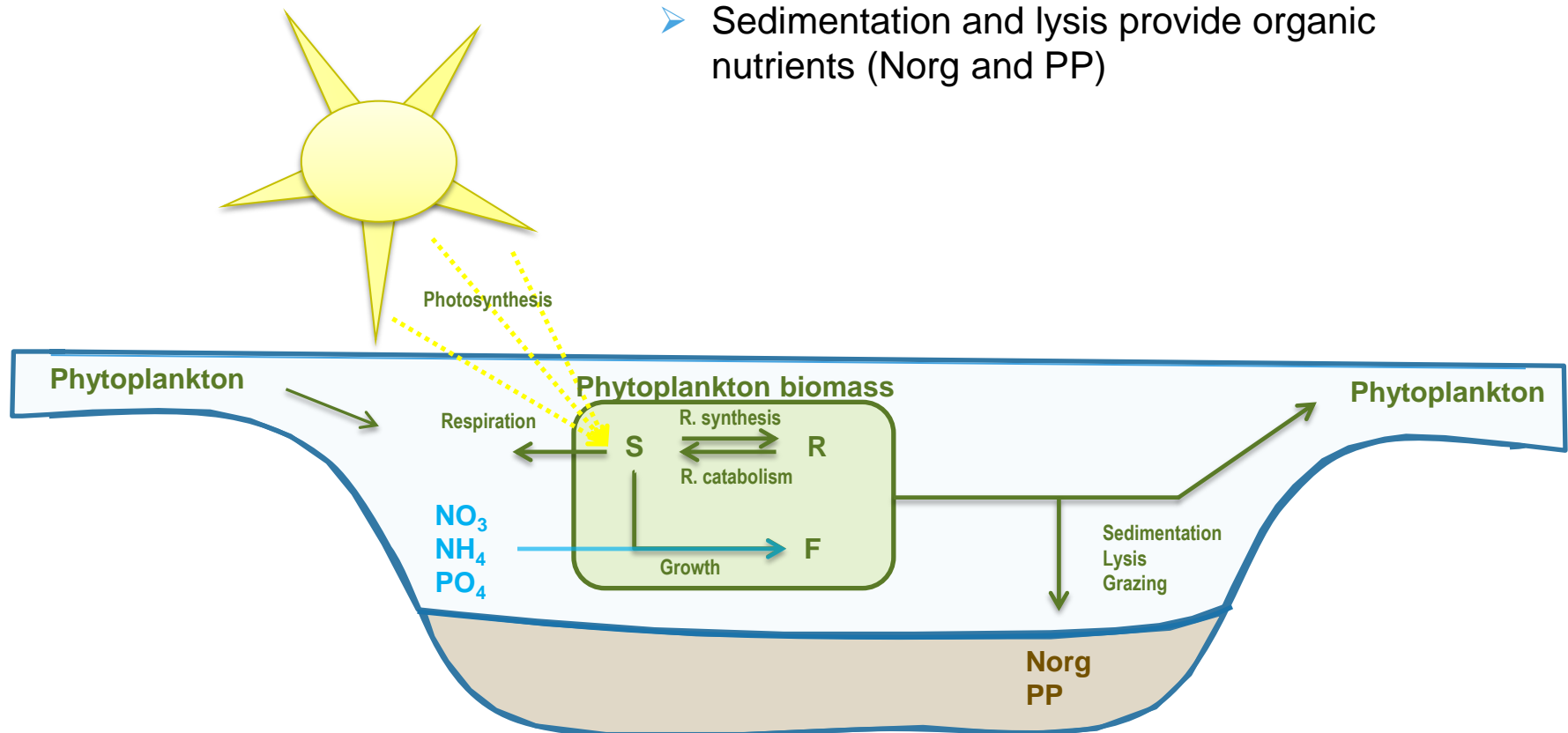

- The phytoplankton model is based on the idea that phytoplanktonic cells synthesize storage material for the future requirement of growth allowing growth to continue in the dark.

Phosphorus cycling: particulate phosphorus (PP) and phosphate (PO_4)

Phosphorus processes in lakes include:

- Transport
- Sedimentation / Resuspension
- Mineralisation
- Adsorption / Desorption
- Phytoplankton assimilation/lysis

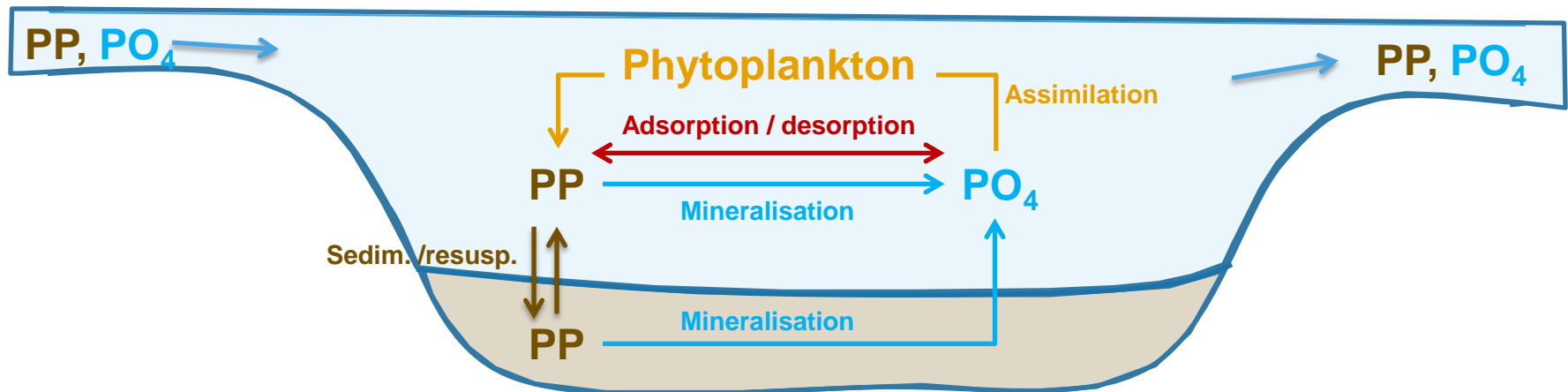

Nitrogen cycling: nitrate (NO_3), ammonium (NH_4) and organic nitrogen (Norg)

Nitrogen processes in the water include:

- Transport
- Sedimentation / Resuspension
- Mineralisation
- Nitrification
- Denitrification
- Phytoplankton assimilation/lysis

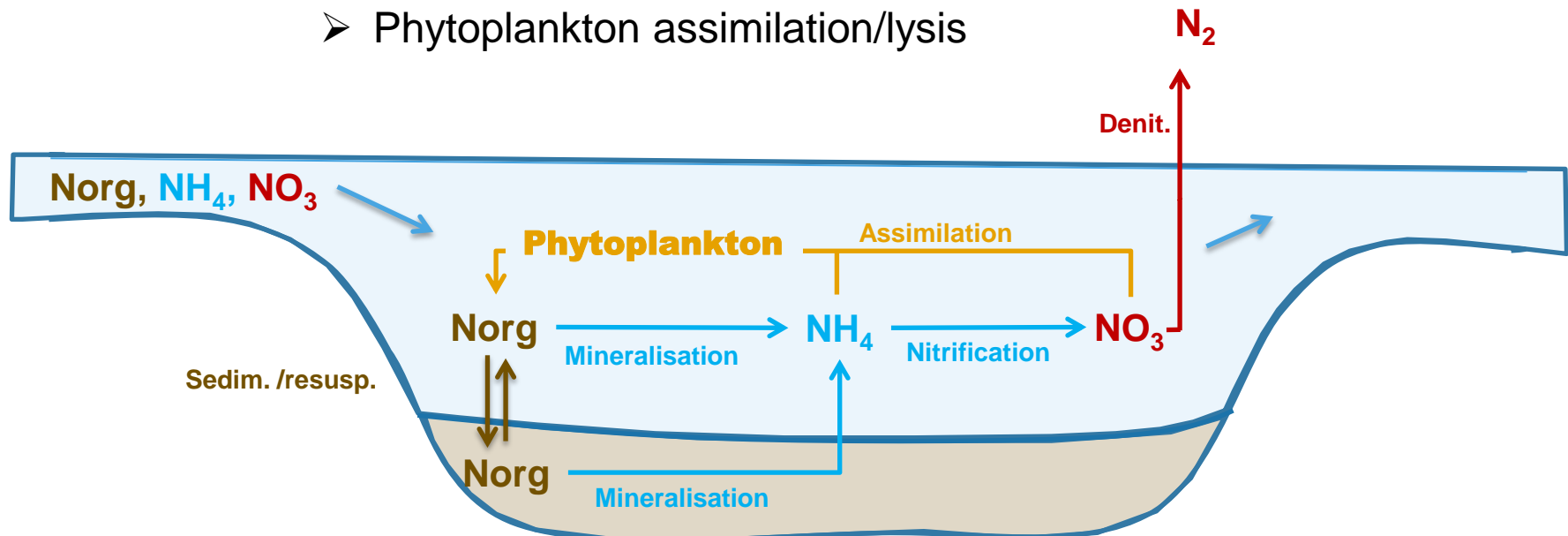

Oxygen (Hanson et al., 2008)

$$\frac{dO_2}{dt} = O_{2t-1} + Photo_{t-1} - Miner_{t-1} + Reaeration_{t-1}$$

- In the oxygen model, oxygen is produced by photosynthesis (gross primary production) and is exchanged with the atmosphere (reaeration). It is also consumed during the respiration process, which includes the mineralisation of the organic matter and the nitrification process.

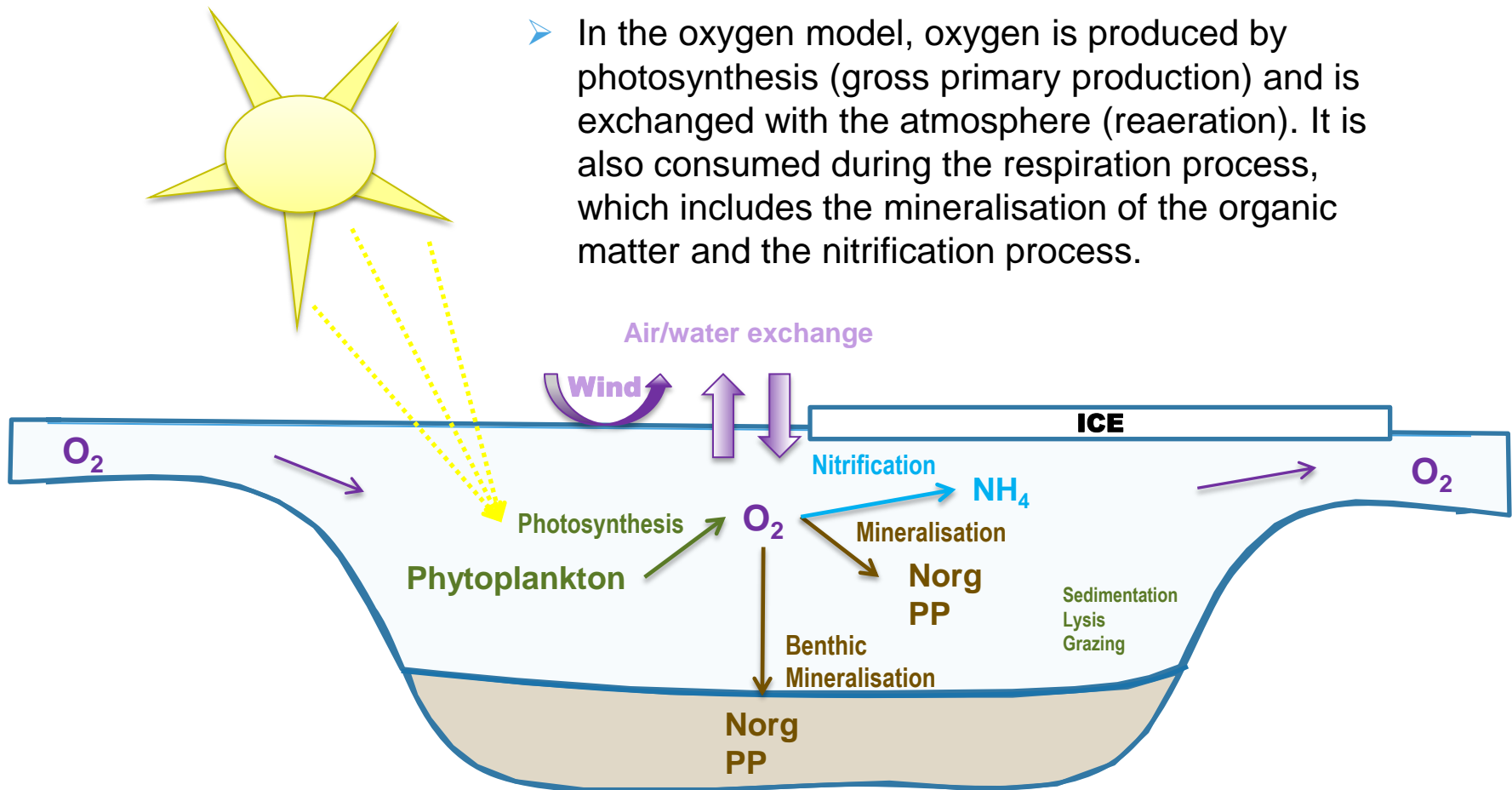

Maankosteuden kaksikerrosmalli

- Operatiivisen maankosteusmallin pohjalta kehitetty fysikaalisempi maankosteusmalli
 - Simuloi maankosteutta maaperän pinta- ja pohjakerroksessa
 - Hyödyntää Suomen maannostietokannan maaperätietoja
 - Kalibroitu käyttäen SYKEN maankosteushavaintoverkkoa
- Edut aiempaan malliin verrattuna
 - Realistisempi maankosteuden alueellinen vaihtelu
 - Mallin tuloksia voidaan verrata suoraan
 - SYKEN maankosteushavaintoihin
 - Maankosteuden kaukokartoitustuotteisiin

15.8.2013
0.26 m³/m³

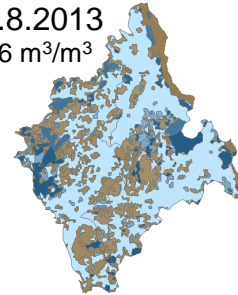

21.8.2013
0.24 m³/m³

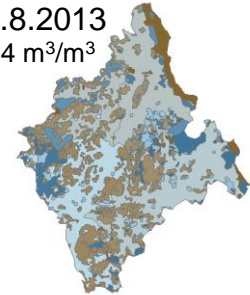

9.9.2013
0.12 m³/m³

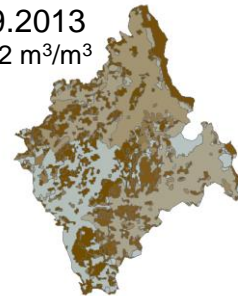

12.9.2013
0.11 m³/m³

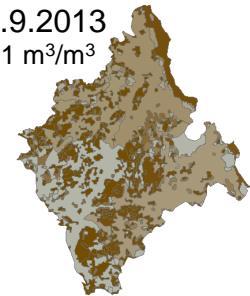

27.9.2013
0.21 m³/m³

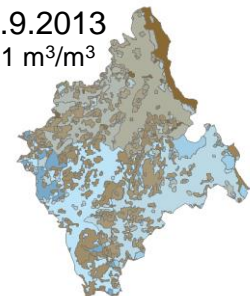

Maankosteuden kaksikerrosmalli

15.8.2013
0.26 m³/m³

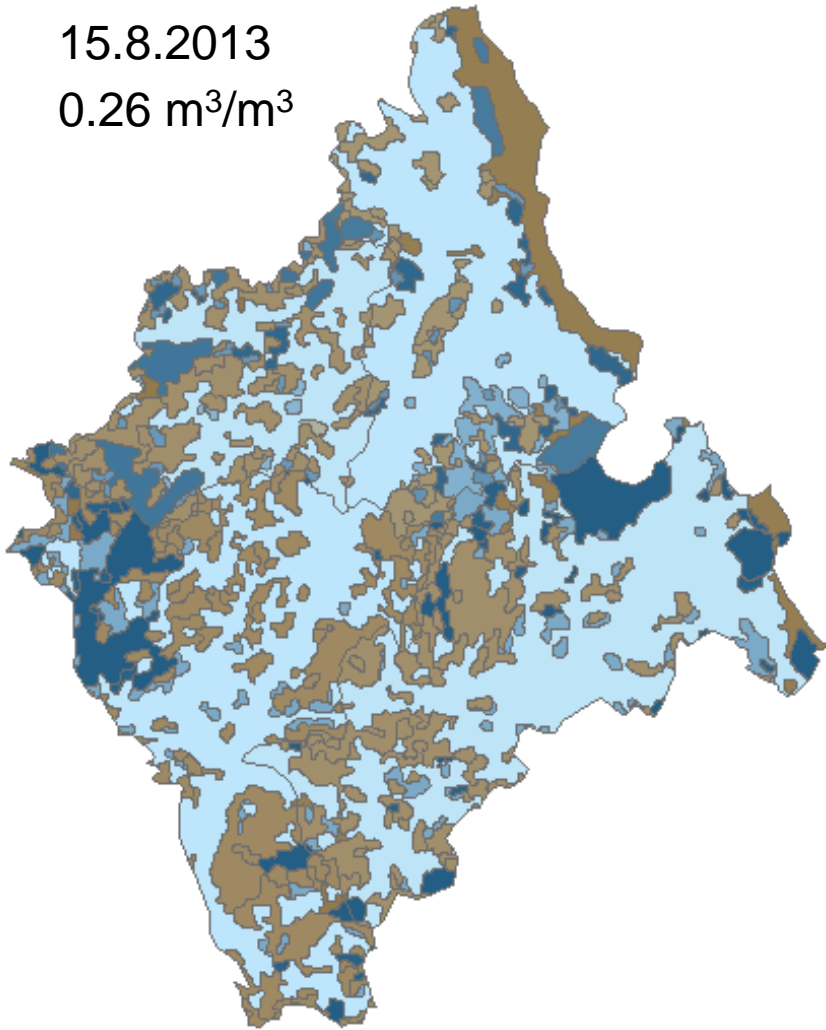

12.9.2013
0.11 m³/m³



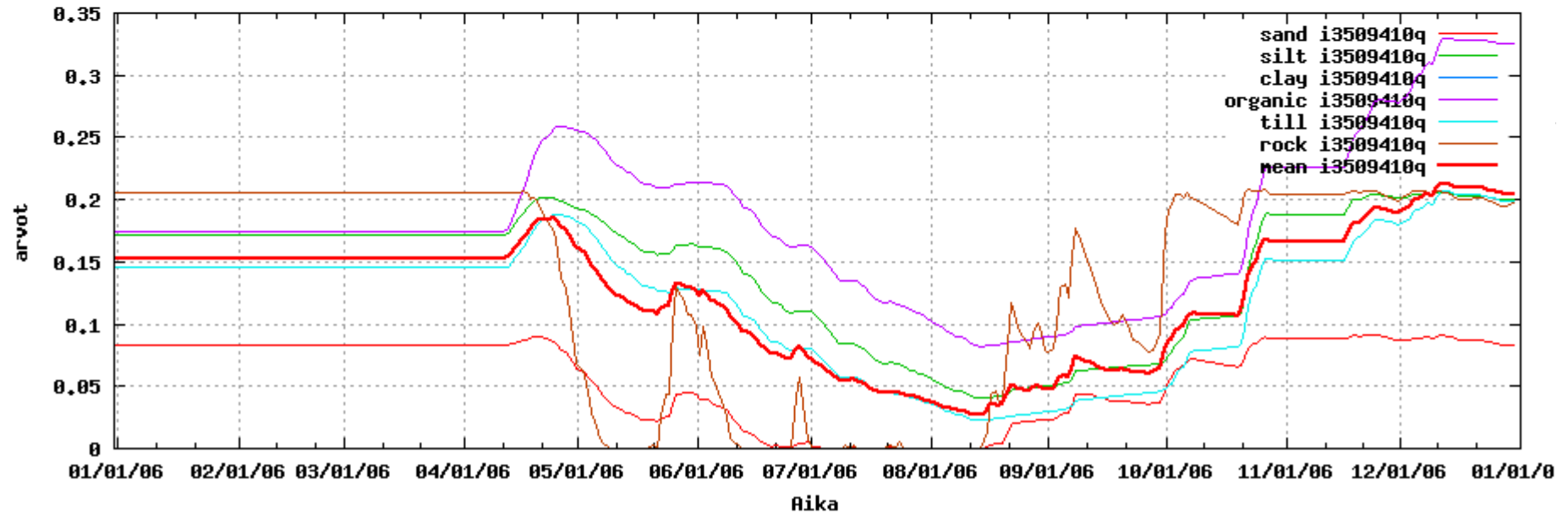
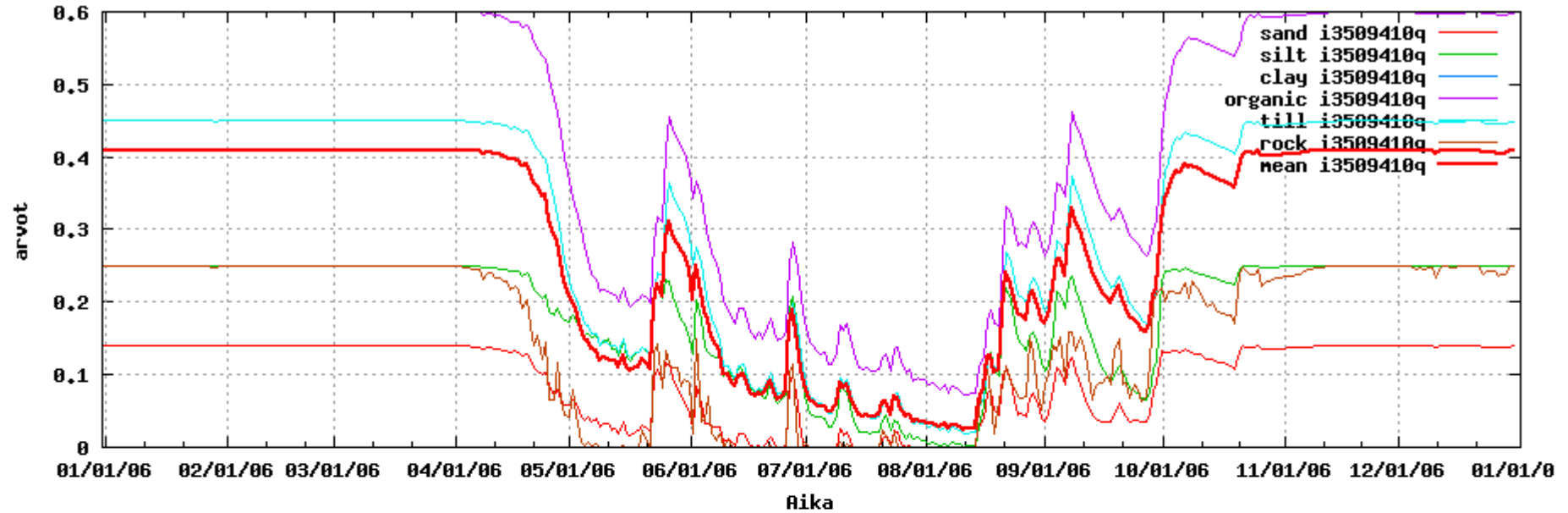

Maankosteuden kaksikerrosmalli

- Testattu neljässä vesistössä
 - Pintakerroksen maankosteuden vertailu SMOS-satelliitin maankosteustuotteeseen
 - Satelliittituotteen käyttö mallin päivityksessä
- Pintakerroksen maankosteuden alueellista vaihtelua vertailtu lentokoneesta tehtyjen HUT-2D-spektrometrin arvoihin
 - Satelliittia tarkempiresoluutioinen kaukokartoitustuote

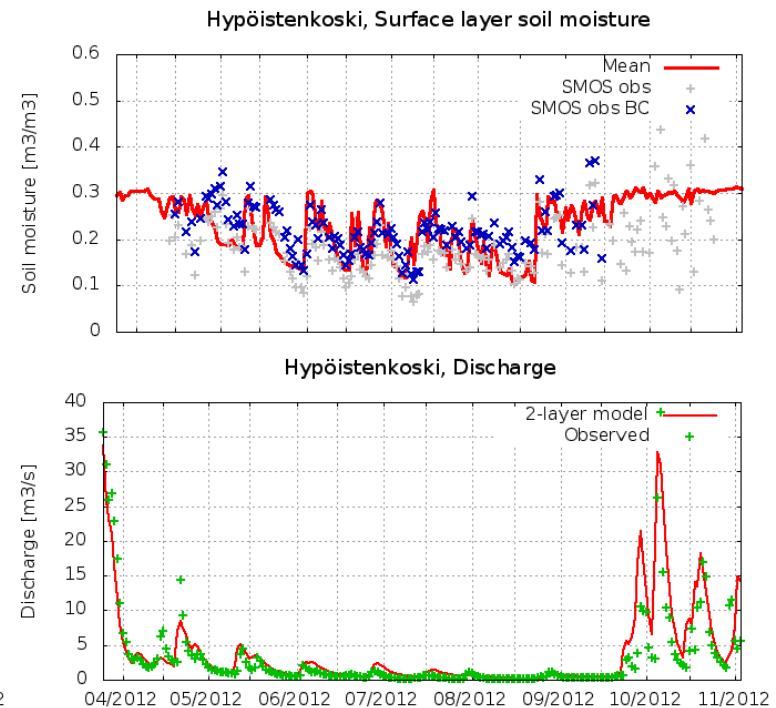
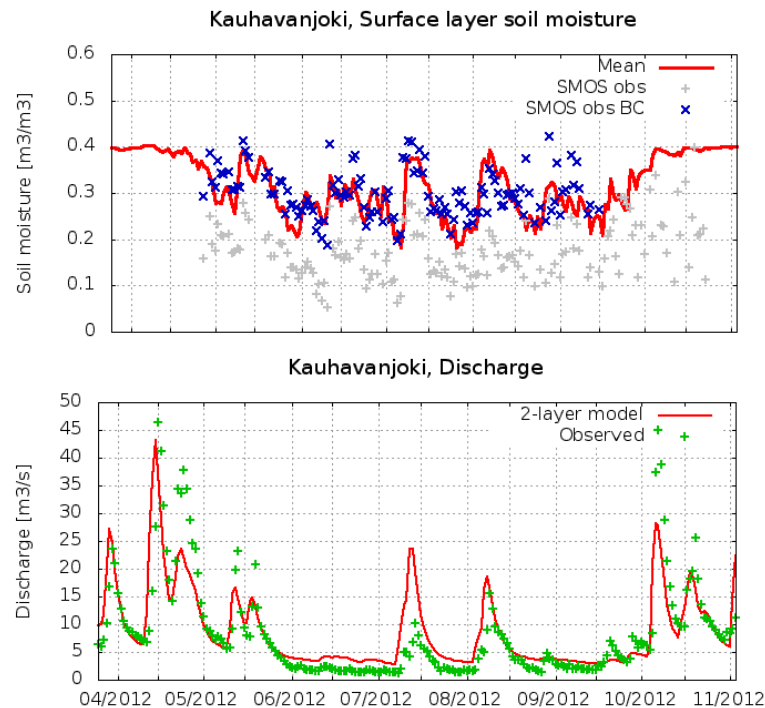

2-layer model updated against SMOS long

Surface layer soil moisture

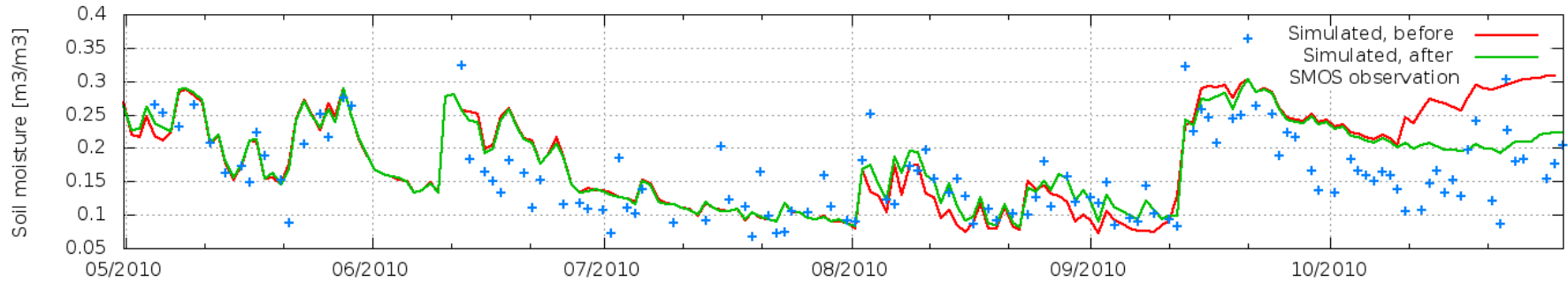

Sub-surface layer soil moisture



Hypöistenkoski discharge

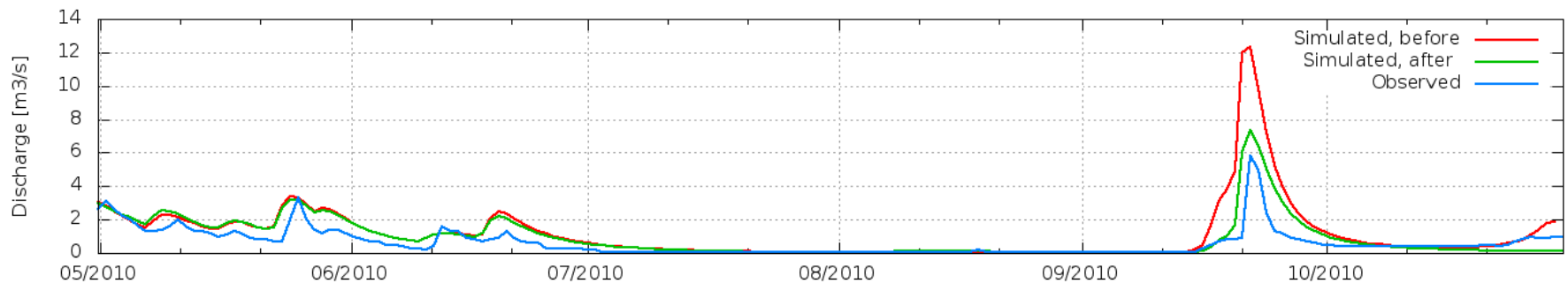

Ground frost modelling

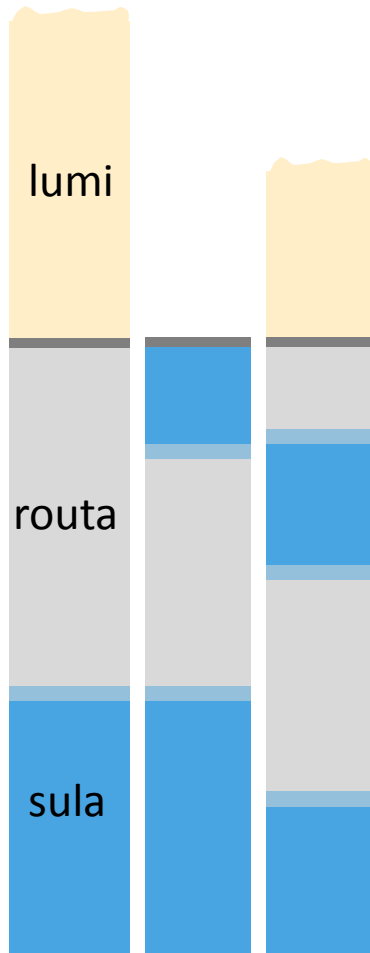

- Tavoitteena on lisätä routamalli operatiiviseen käyttöön.
- Eri aluetyypit huomioidaan erikseen (metsä, aukea, suo)
- Sula-routa kerroksia voi olla useampia

- Malli on yksinkertainen:
 - Kaikki lämpöenergia käytetään sulamiseen / jäätymiseen.
 - Maan lämmönjohtumisen mallintamiseen käytetään sovitettavia parametrejä.

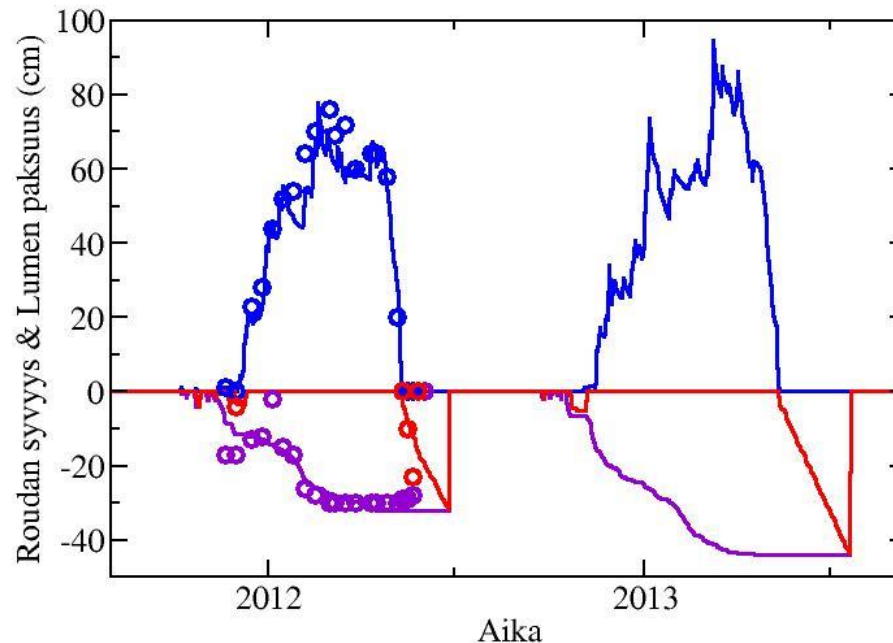

Esimerkki: Suo, Ylitornio Meltosjärvi (alustavia tuloksia)

Lumi
Jäätymisraja
Sulamisraja

Roudan mallintaminen – malli tarkemmin

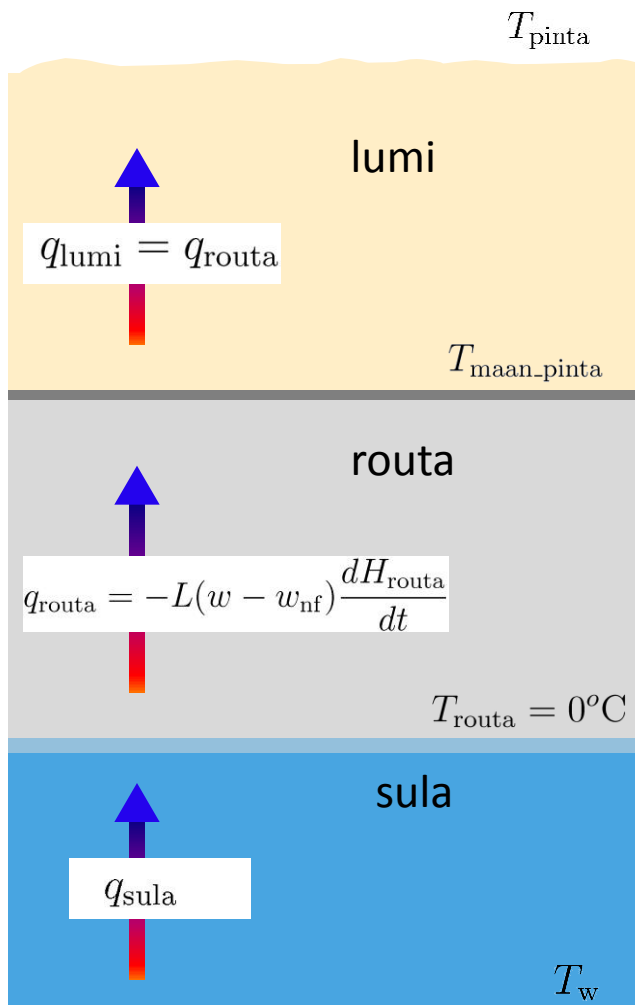

Lähtökohta on lämmön johtumisen yhtälö:

$$q = -k \frac{dT}{dz}, \quad C \approx 0$$

Routakerroksen kasvu:

$$H_{roua,t+\Delta t} = -\frac{k_{roua}}{k_{lumi}} H_{lumi} + \sqrt{\left(\frac{k_{roua}}{k_{lumi}} H_{lumi} + H_{roua,t}\right)^2 - \frac{2k_{roua}T_{pinta}\Delta t}{L(w - w_{nf})}}$$

Vastaavasti sulan maan kerroksen kasvu:

$$q_{sula} \quad H_{sula,t+\Delta t} = \sqrt{(H_{sula,t})^2 - \frac{2k_{sula}T_{pinta}\Delta t}{L(w - w_{nf})}}$$

Lämmönjohtavuudet $k_{lumi}, k_{sula}, k_{roua}$) riippuvat lämpötilasta, maaperän tyypistä, kosteudesta, lumen tiheydestä ja mikrorakenteesta. Tässä käytetään yksinkertaisia kaavoja yhdistettynä sovitettaviin parametreihin niiden laskemisessa.

Lumimalli

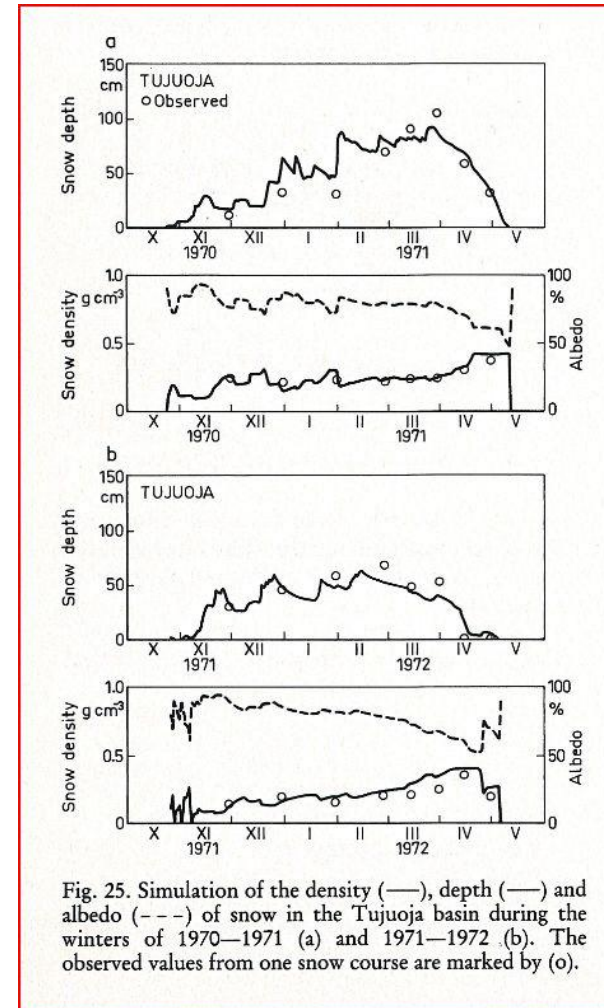
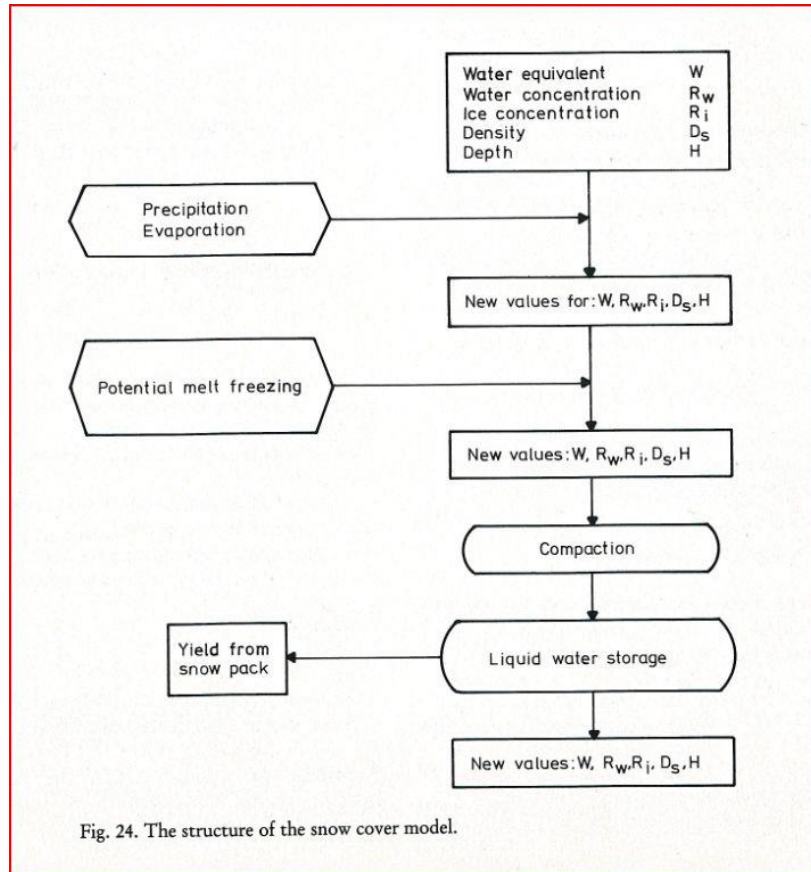

Lumimalli

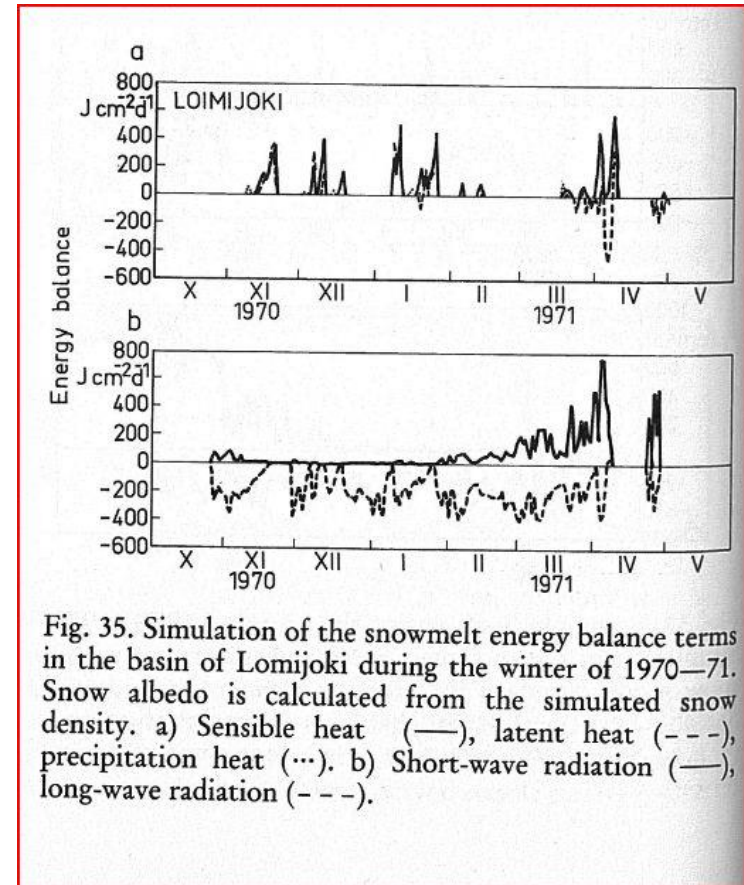
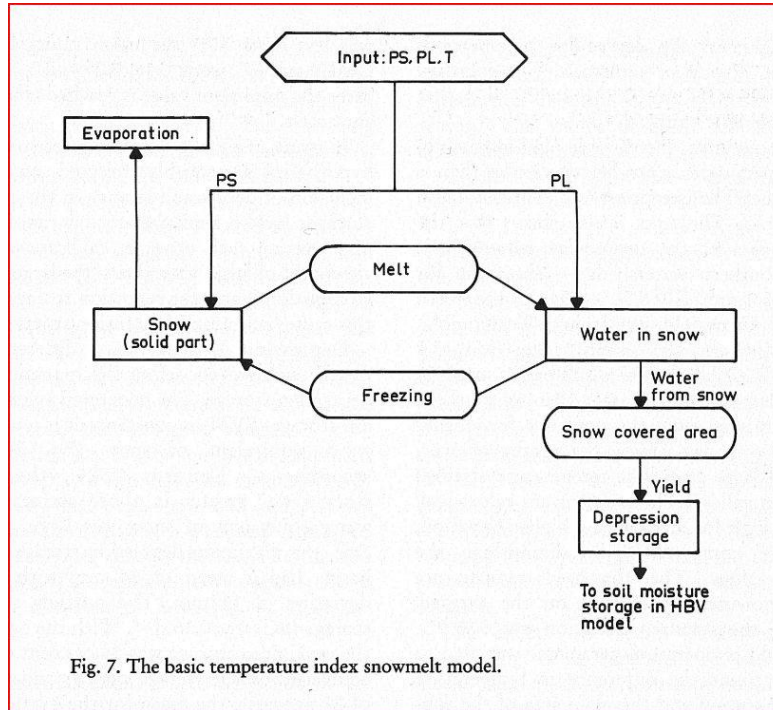

Snow energy balance

- Snow melt simulation is based on energy fluxes affecting to snow layer
- More physical approach to snow melt process compared to simpler day-degree method

- Important factors:
precipitation
heat,
shortwave
and longwave
radiation,
sensible and
latent heat
fluxes

Rutavan alueen (Kokemäenjoki) lumen energiataseen komponentit vuodelta 2010

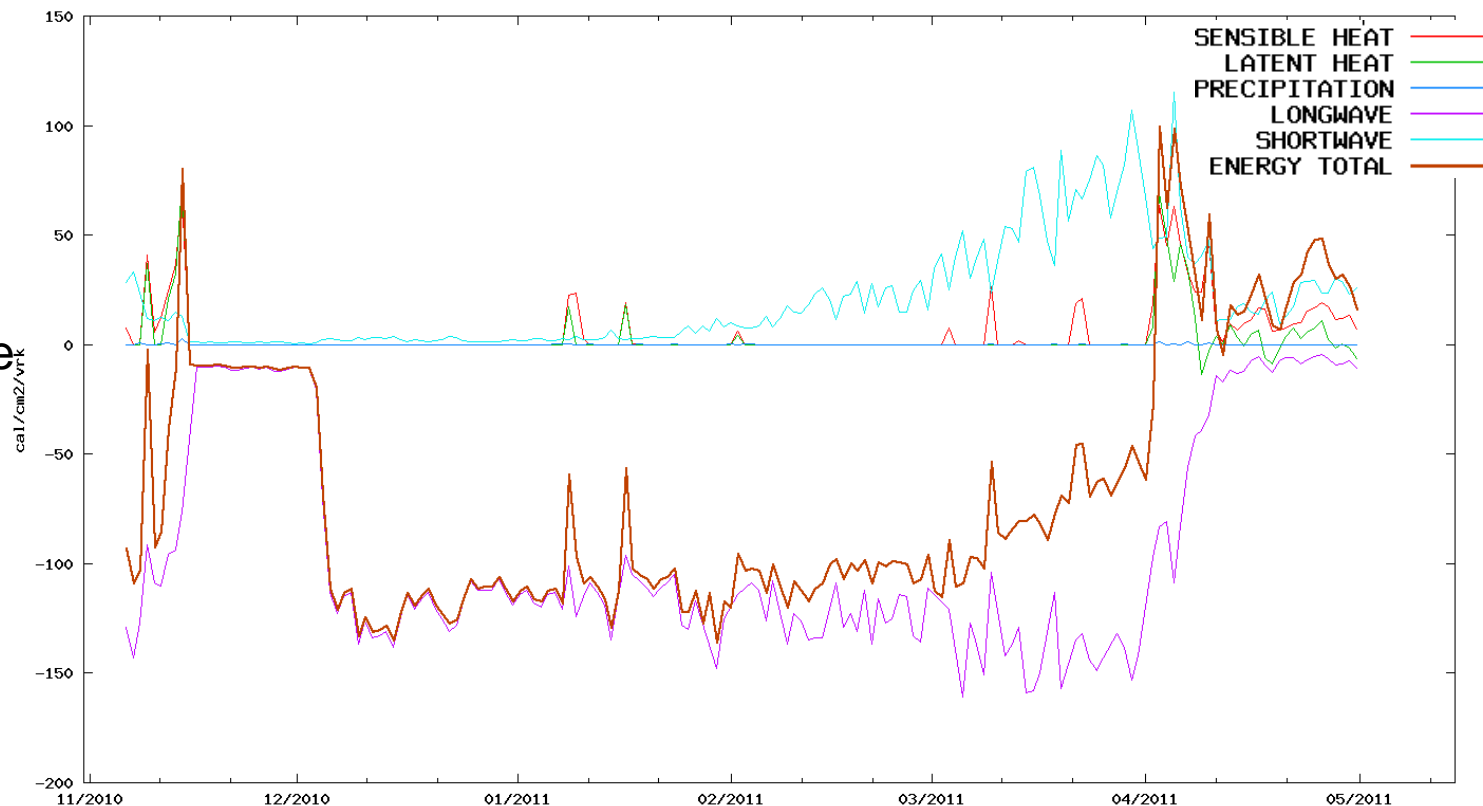

Development

- Implementation to WSFS
 - replaces the current day degree snow melt method
 - Support processes: shortwave radiation simulation using cloudiness observations, snow internal energy
 - Parameter calibration
 - Testing and validation
- Expected to improve snow simulation especially during the spring time due more physically correct method

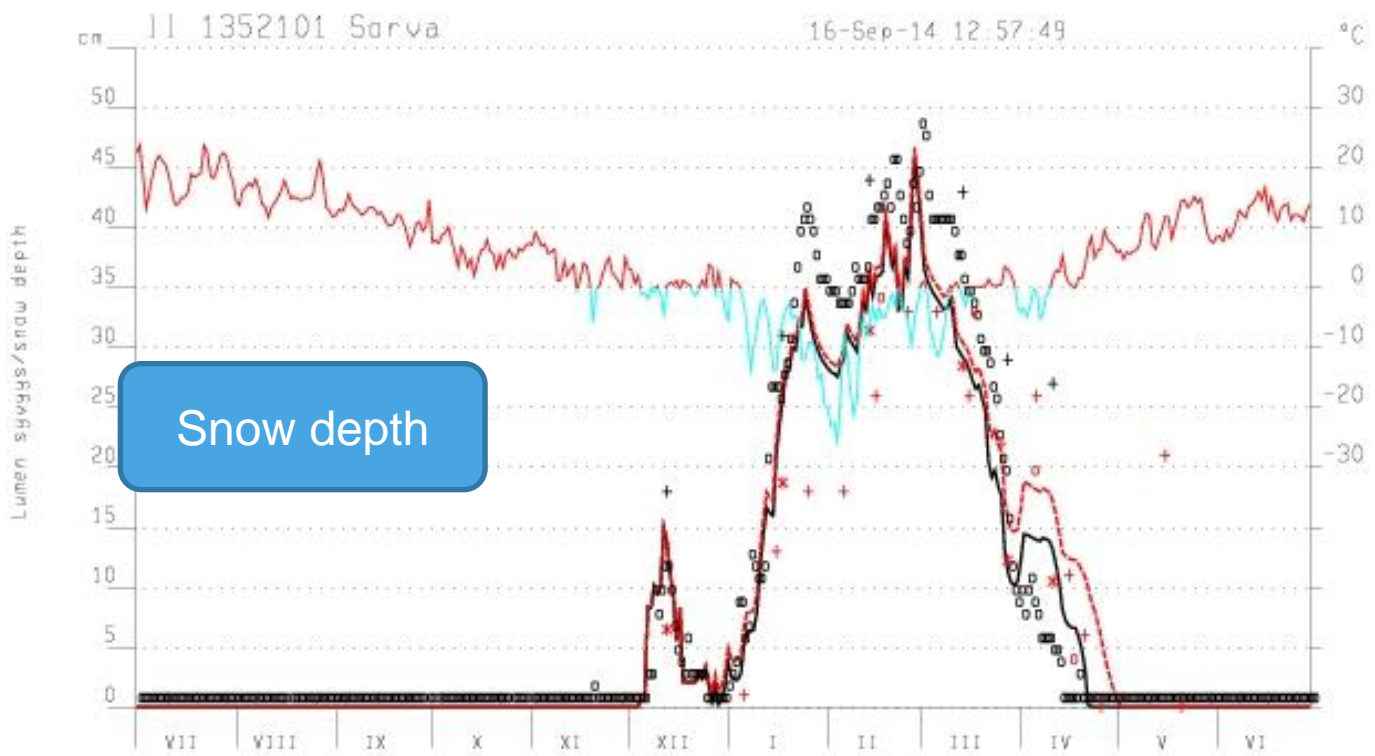

E = ennusteen alku
 Lumen syvyys, aukea (55 %)
 Lumen syvyys, metsä (44 %)
 * = s 1215 Tampere-Pir Hav. aukea (0.458)
 + = l 1352101 Sorva Hav. aukea (0.257)
 o = s 1213 NOKIA TOTTI Hav. aukea (0.129)
 x = 1352101 Sorva H av. metsä (0.788)
 + = RO301sMet PALKAN E: Ht Hav. metsä (0.057)
 o = 1352801 Urjala, H av. metsä (0.033)
 Lämpötila 35 211

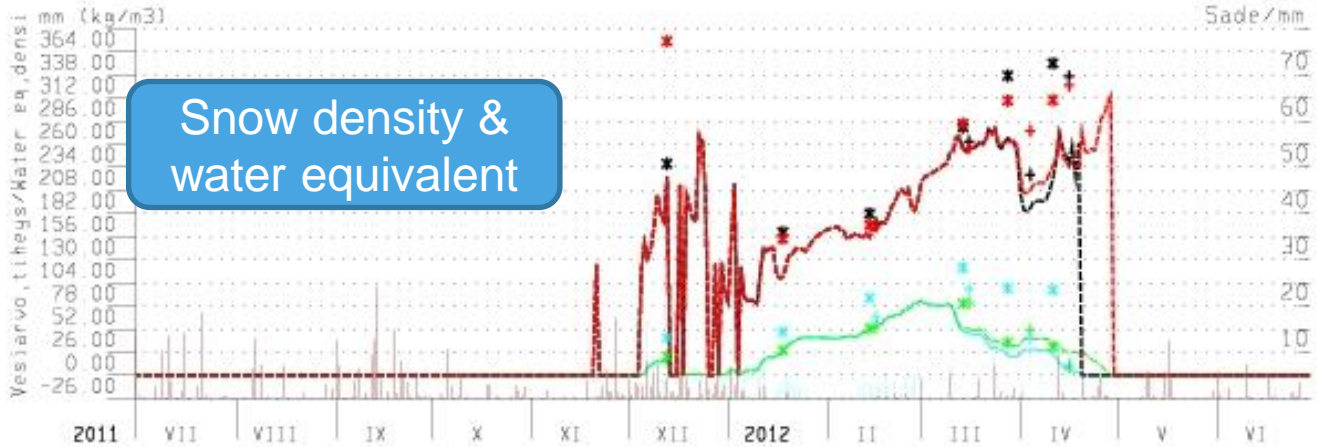

Lumen vesiarvo aukea
 Lumen vesiarvo metsä
 Lumen tiheys aukea (kg/m3)
 Lumen tiheys metsä (kg/m3)
 * = 1352101 Sorva H av. aukea (0.257)
 + = 1352801 Urjala, H av. aukea (0.012)
 o = 1351502 Mouhijär H av. aukea (0.009)
 x = 1352101 Sorva H av. metsä (0.788)
 + = 1352801 Urjala, H av. metsä (0.033)

Roudan ja lumen mallintaminen –esimerkki

Roudan paksuus

Lumen paksuus

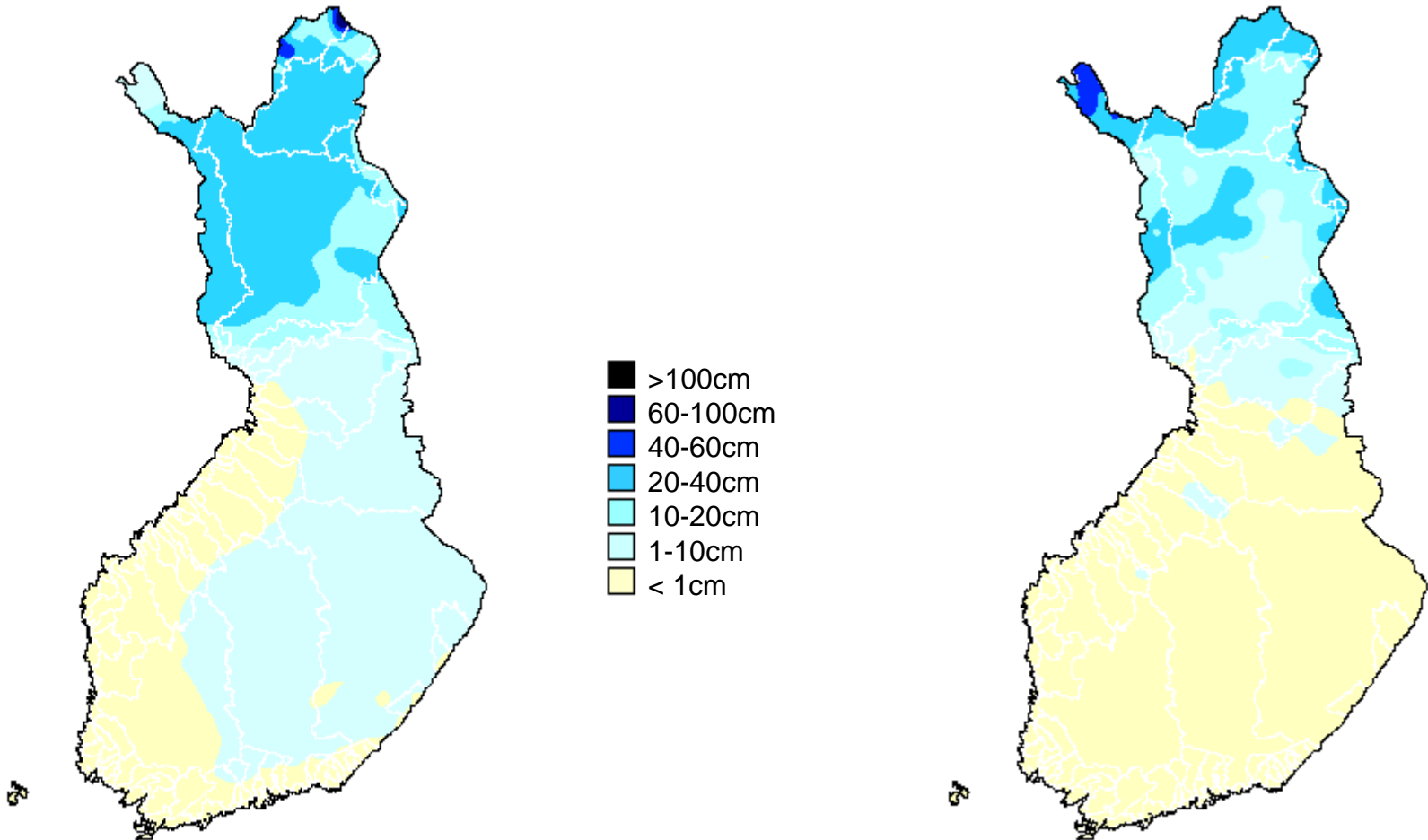

Tailored hydrological modelling solutions

- Minimum data requirements for hydrological model:
 - 1 time series of discharge observations
 - 1 time series of precipitation observations
 - basin information (area, location)
- Other data: we will use all available data for the model
 - Observations
 - Forecasts
 - Radar products
 - Satellite products
- We will provide a **FULL FORECASTING SYSTEM**
 - Automatic forecast simulations (also an option for manual runs)
 - Correction of model state according to the latest observations
 - Online user interface
 - Flood risk maps (additional)

Tailored solutions, daily data flow example

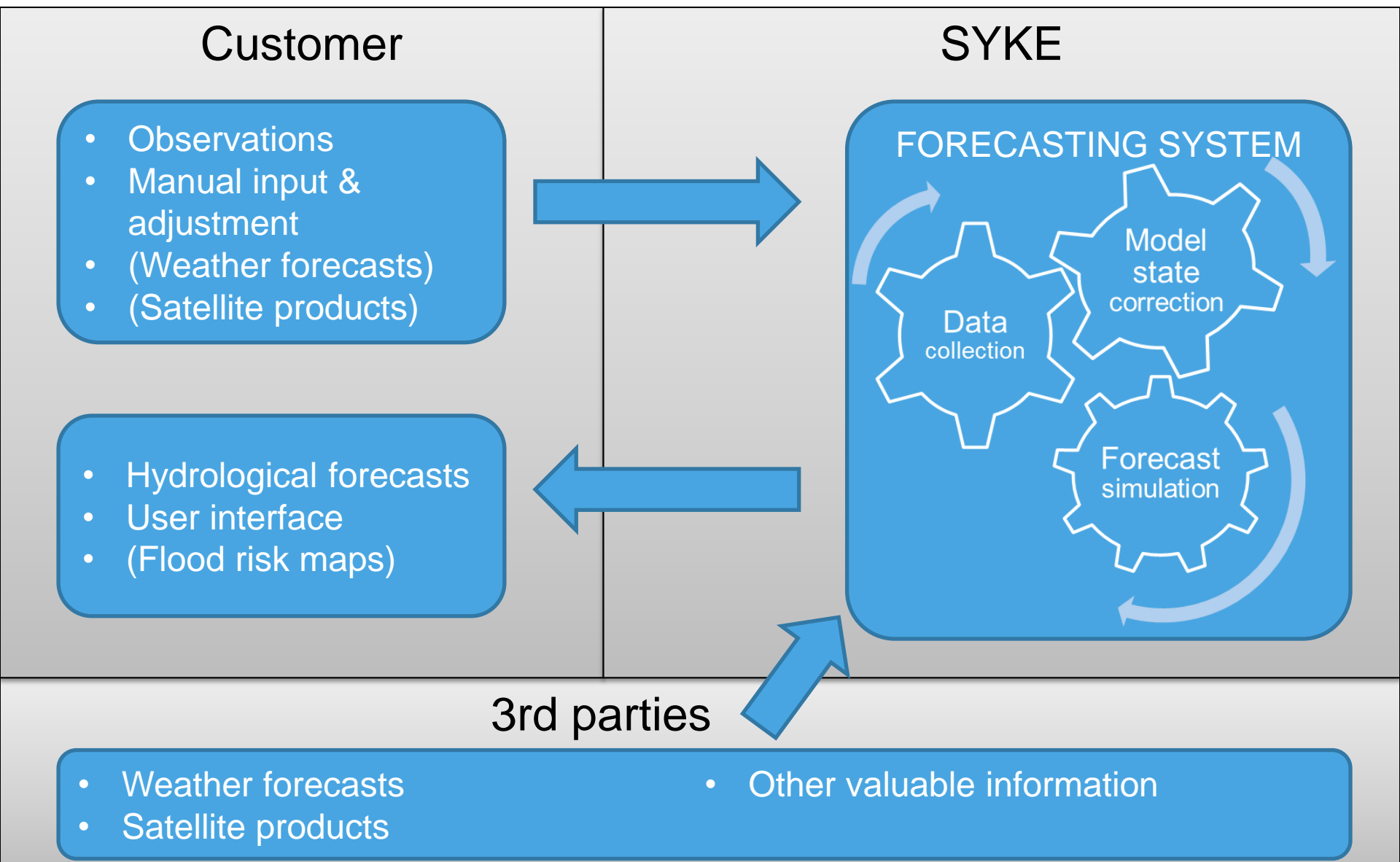

Example in Sweden

- 6 catchments modelled
- Users: Fortum, Vattenregleringsföretagen VRF, Vattenfall

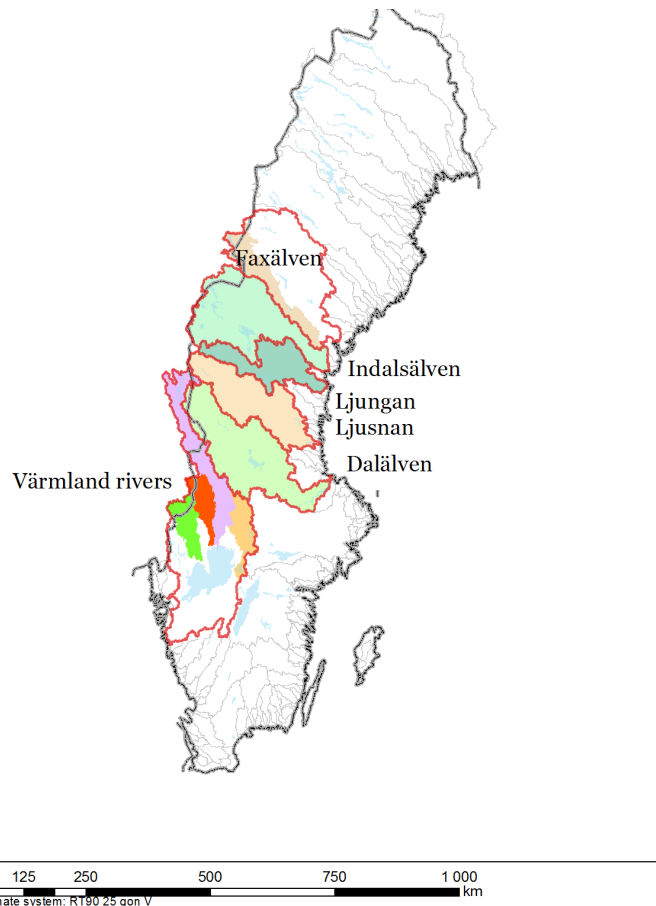

Example in Russia

- Tuloma-river
- User: TGC-1 in Murmansk Oblast
- Tailor-made PC solution in place



Lakes

04 001 001	Sloka floodplain
04 002 001	Kalnciems floodplain
04 003 001	Jelgava floodplain
04 004 001	Stalgene floodplain
04 005 001	Mezotne floodplain
04 002 002	Slokas lake
04 009 001	Babites lake
04 022 001	Viesītes lake

River points

04.001	0473804 Lielupe Lielupesgrīv
04.002	0411202 Zvirbulu Strauts*
04.002	0473803 Lielupe Sloka
04.003	0473802 Lielupe Kalnciems
04.004	0473520 Platone, Lielplatone*
04.004	0473801 Lielupe Jelgava
04.005	0473424 Lielupe Stalgene
04.006	0473422 Lielupe Mezotne

Lielupe watershed



Maps: Gauja Lielupe Venta



Example in Latvia

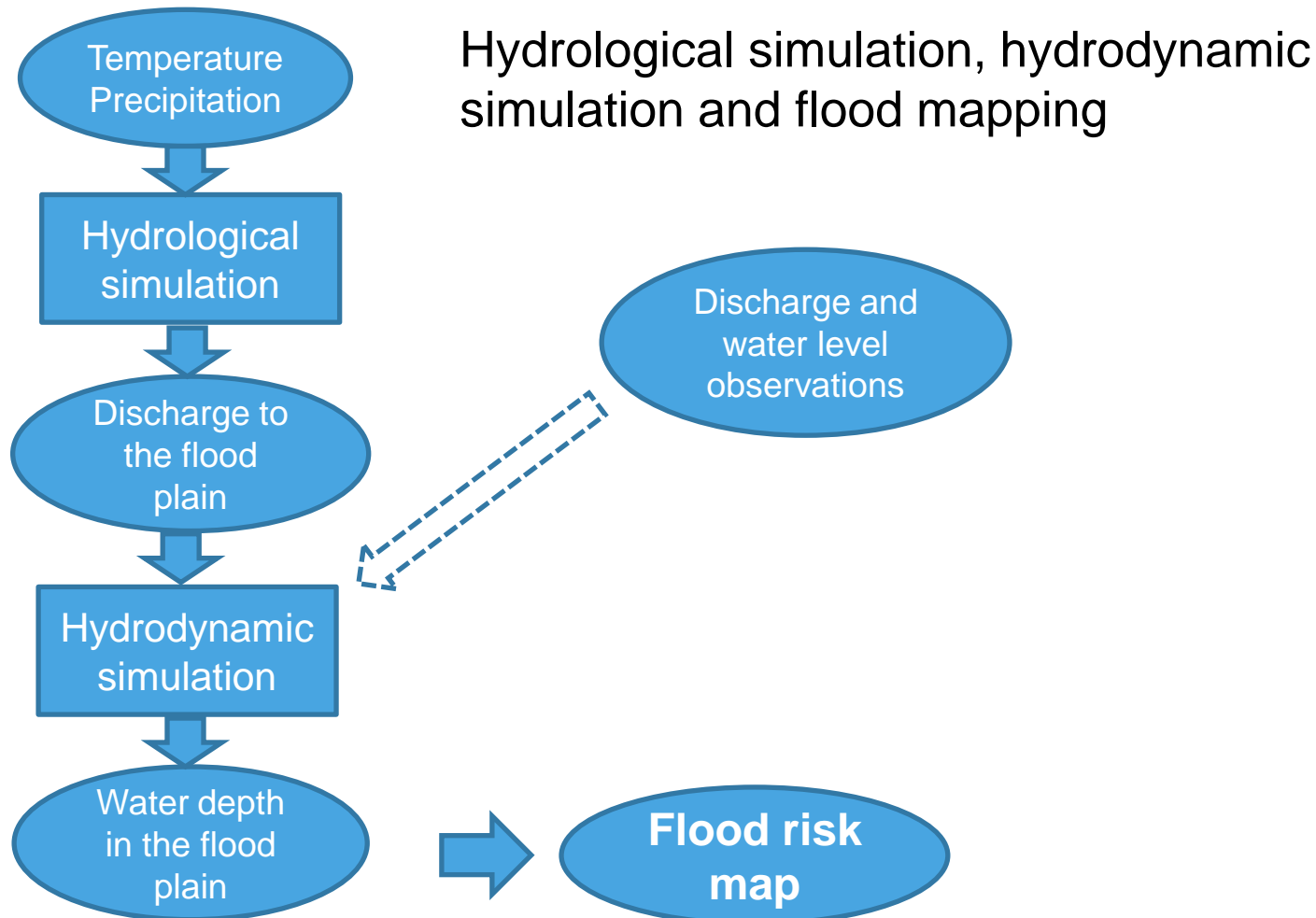

Watersmart: simulating water balance of mining areas

- **Aims to simulate water balance of mining areas**
 - Water level, discharge
 - Ground water
 - Water balance components
 - Real-time forecasts
 - Transport of marker substances
- Currently developed in YARA Siilinjärvi mine
- WSFS modified to mining area
 - Description of watersheds in the area
 - Observations from area (water level, discharge, pumping) or from nearby weather stations

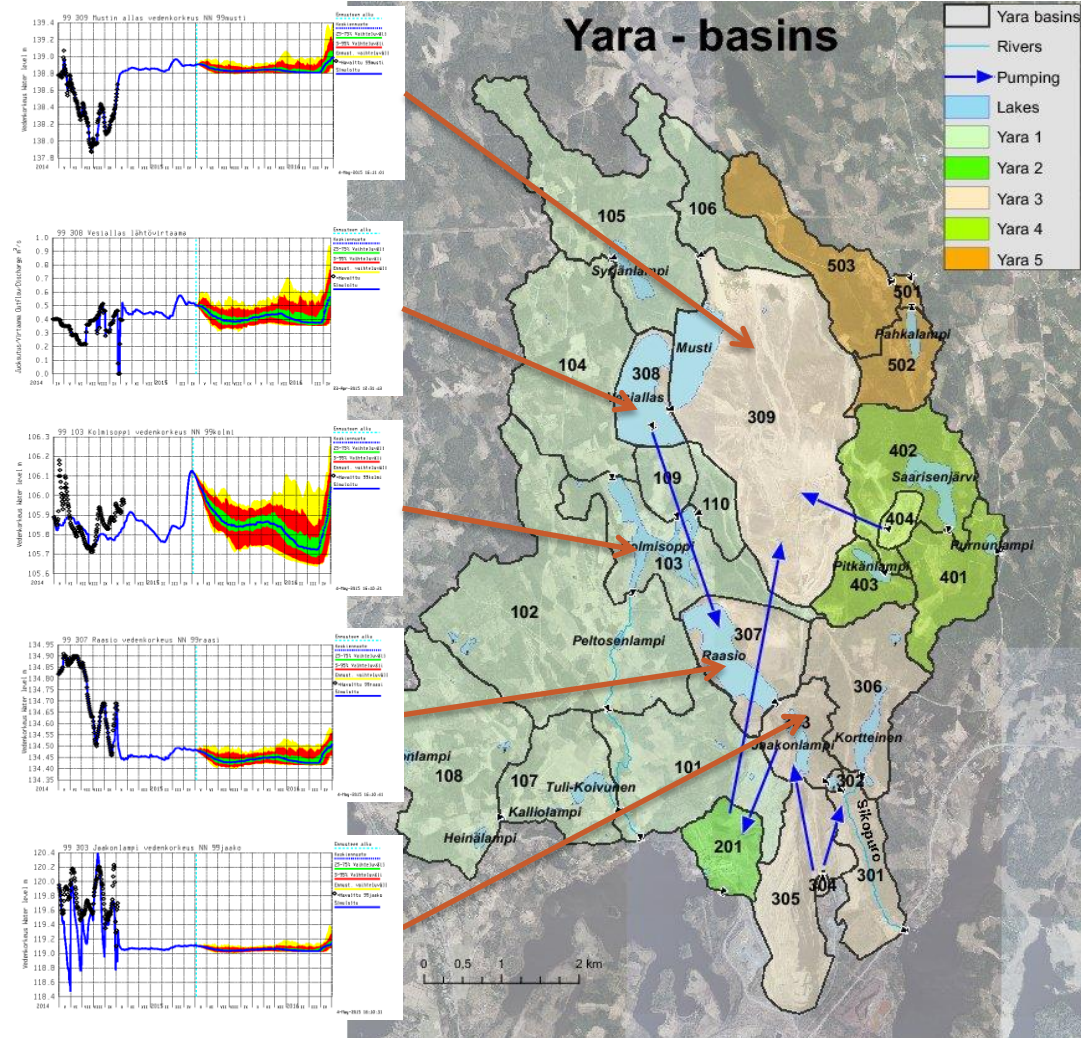

Example:
Yara
mining
area



Example: Yara mining area

Lake / reservoir water levels and outflow discharges

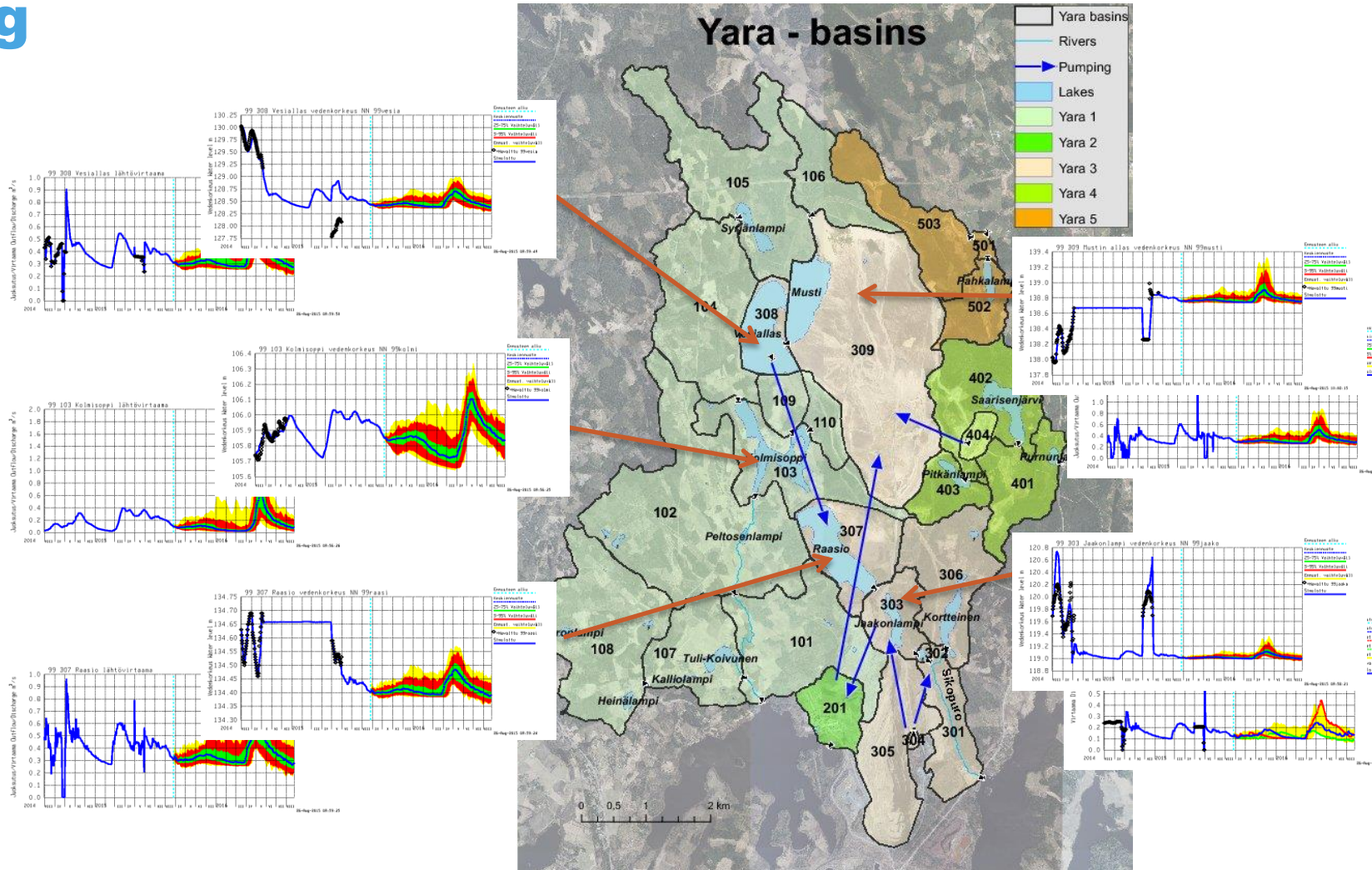

Example: Yara mining area

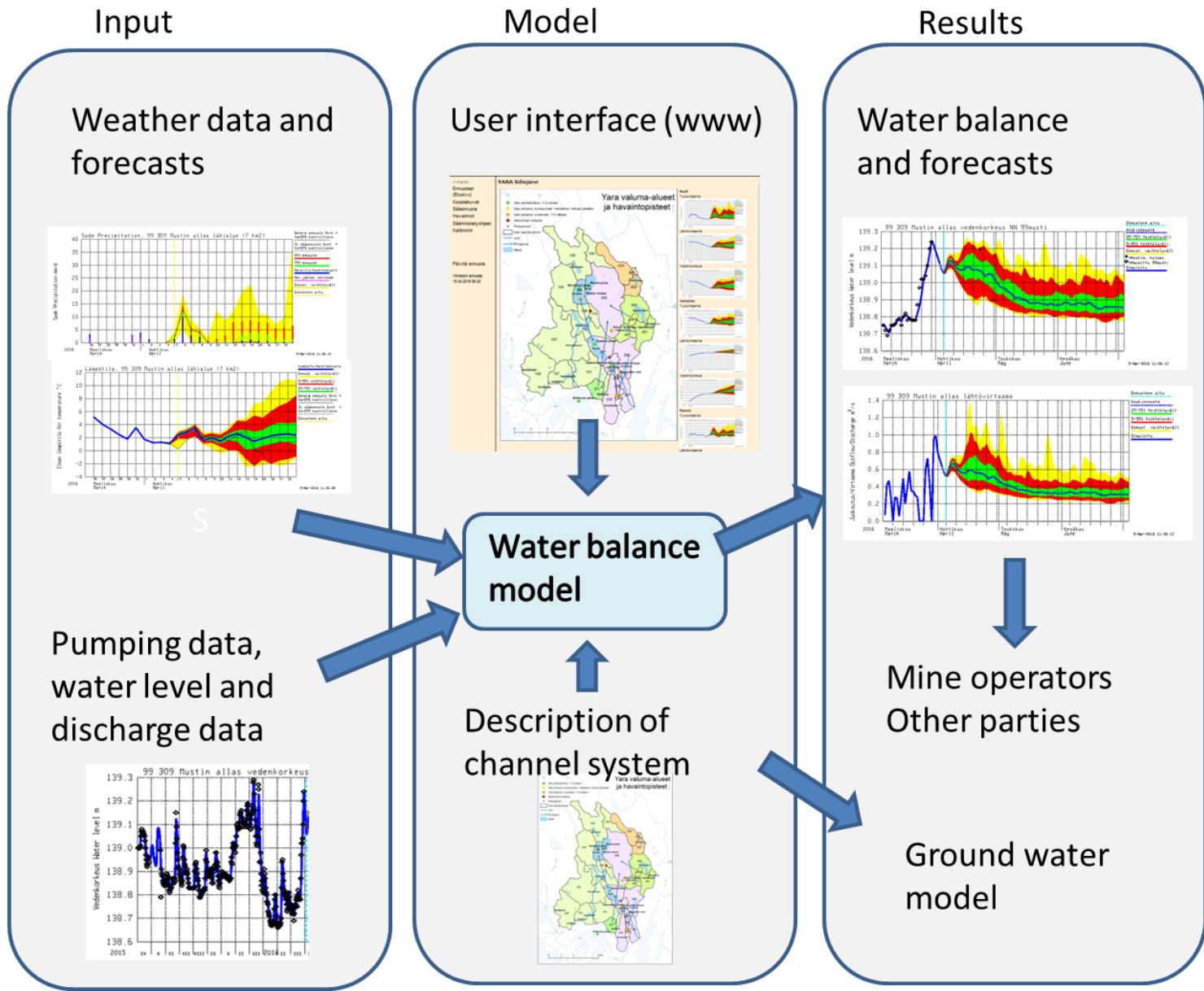

Operative forecasts for Talvivaara mining area

- Main lakes and water flows between them in Talvivaara mining area are in the operative WSFS model
- Forecast also for runoff of Kalliojoki, which is the limiting factor for discharge of Latosuo and Korttelampi
- Forecasts run daily and are sent directly to Talvivaara

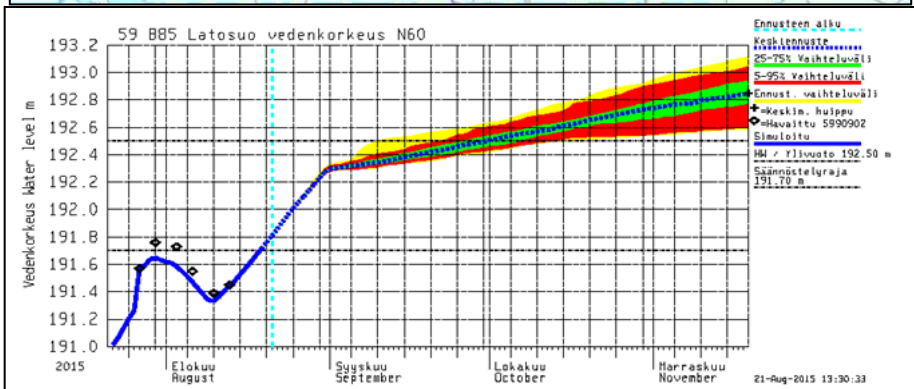
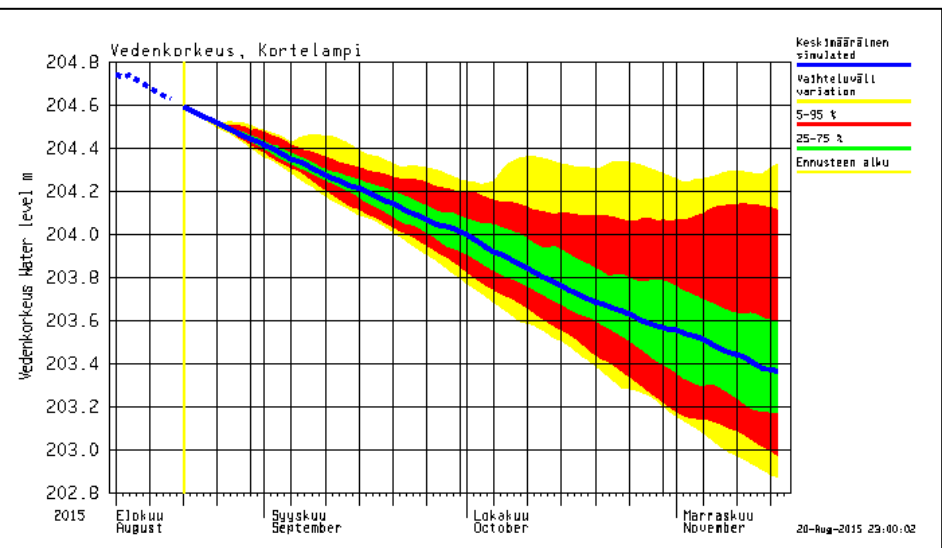
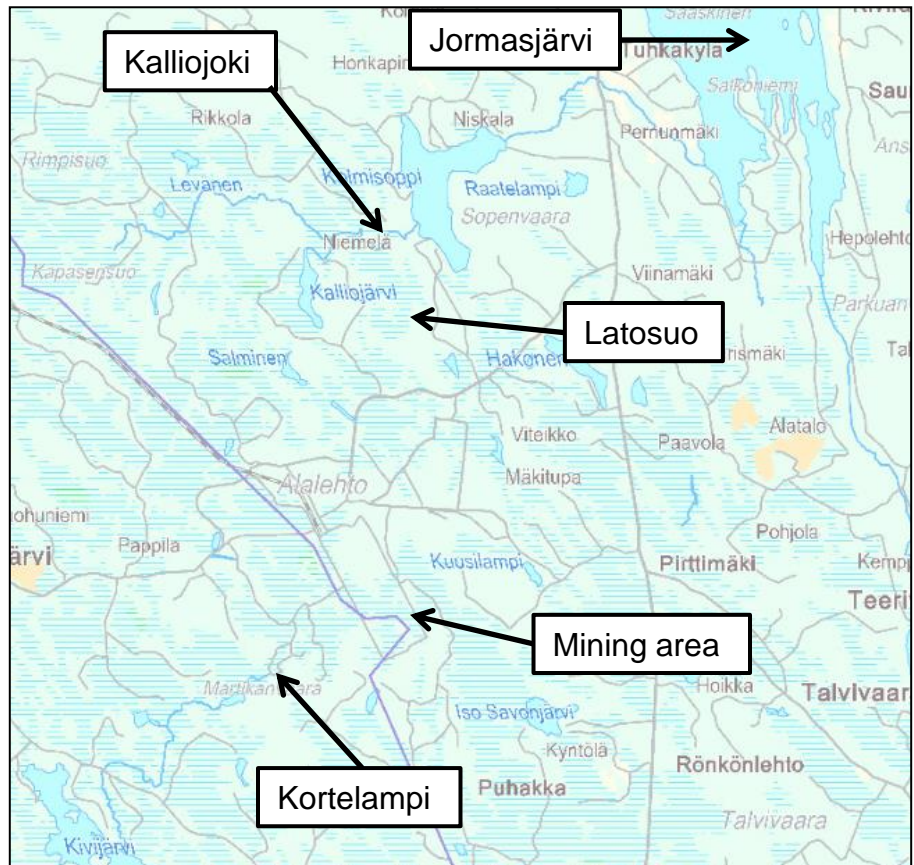

Operative forecasts for Talvivaara mining area

- Weekly reporting of Talvivaara water situation (also daily reporting if needed)

Talvivaaran patoaltaiden vesitilanne ja ennusteet

Raportti 21.8.2015

Harri Myllyniemi
Juho Jakkila

Ennusteet tiivistetysti

Kortelammen vedenkorkeus ylittää ylärajan 204.20 m viimeisimmän havainnon (13.8.) mukaan 52 cm:llä. Ennustemallin mukaan vedenkorkeus on laskenut tämän jälkeen 10-15 cm. **Kipsisakka-altaiden vedet eivät mahdu Kortelammen altaaseen ja Lumelan allas on edelleen ylärajan 207.00 m yläpuolella.** Tämänhetkisen luvan mukaan konkurssipesä ei saa jatkaa juoksutuksia etelään. **Konkurssipesä on aloittanut heinäkuun puolivälissä pumppaukset Kortelammen ja Lumelan altaista Tammalammen jälkikäsittely-yksikköön. Pumppauksen suuruus on tällä hetkellä 500 m³/h, mikä riittää ennusteen mukaan pitämään Kortelammen vedenkorkeuden laskussa.**

Latosuon tuorein vedenkorkeushavainto on 13.8., vedenkorkeuden ollessa tasolla 191,46 eli 24 cm säännöstelyn ylärajan alapuolella. Mallin mukaan **pinta on ylittänyt 10 cm säännöstelyn ylärajan.** Latosuon vedenkorkeus on ollut nousussa siitä lähtien kun juoksutus Kuusilammelta aloitettiin 10.8.. **Latosuolta juoksetetaan vettä luontoon Kalliojoen virtaamaan suhteutettu määrä ainakin elokuun loppuun asti.**

Vesienhallinnan kannalta **suosittelemme automaattiasemien perustamista** ainakin tärkeimmille altaille, kuten Kortelammelle ja Latosuolle. Ilman reaaliaikaisia havaintoja vesitilanteen ennustaminen on kriittisessä tilanteessa vain suuntaa-antavaa. Tulvan ja muiden ääritilanteiden yhteydessä ennustaminen riippuu enemmän havainnoista kuin tavanomaisessa tilanteessa.

Muutos edelliseen raporttiin

Kortelammen pinta on laskenut viikossa noin 10-15 cm, mutta vastaavasti Latosuon allas on täyttymässä. Kulunut viikko on ollut sateeton ja ennusteen mukaan myös lähipäivien sää jatkuu sateettomana, joten Kortelampi saataneen elokuun loppuun mennessä tasolle jolla kipsisakka-altaan vedet mahtuvat sinne tarvittaessa. Mikäli pumppauksia Tammalampeen jatketaan nykyisellä tasolla vedenkorkeus laskee todennäköisesti ylärajan 204.20 m alapuolelle syyskuun puolivälissä, jollei syyskuun alussa tule runsaita sateita.

Work flow for water balance simulation for mines

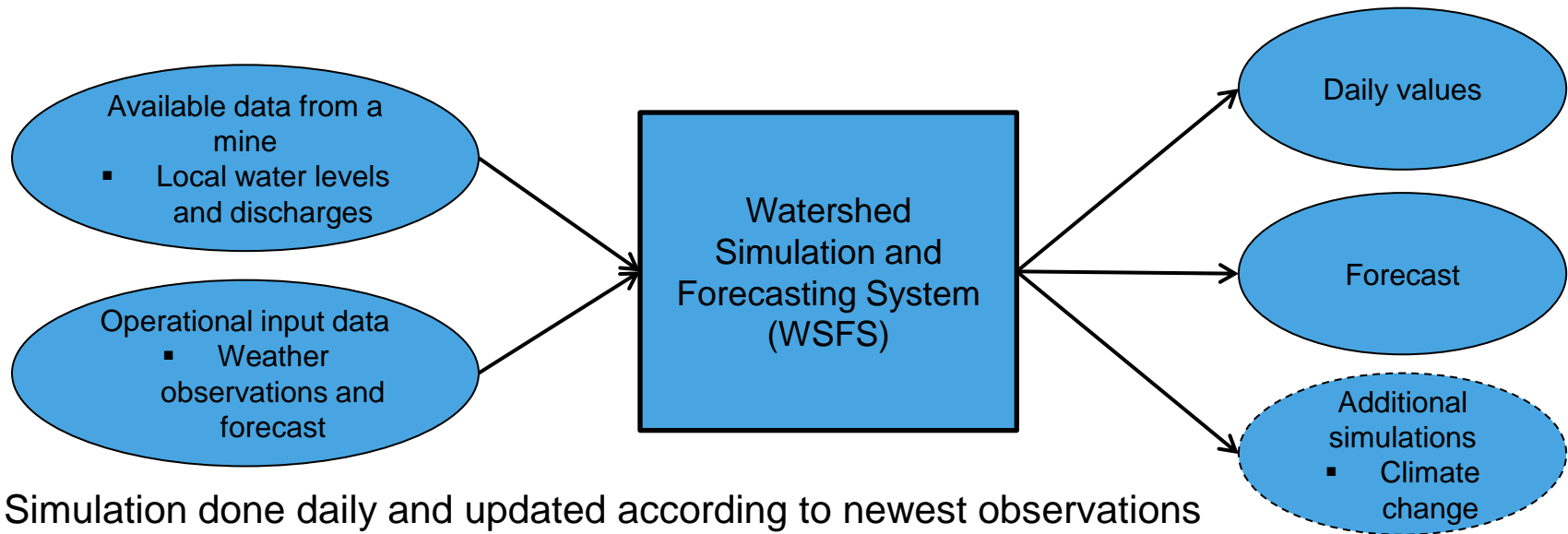

Simulation done daily and updated according to newest observations

Case Kittilä mine in SAM project

- Areal water balance simulation of Kittilä mine local area as a case subject
- A part of the operational system
- Results and forecasts presented in the webpage for easier accessibility
 - Daily updates
 - Figures and numerical forecasts

DEMOLA can simulate the transport of inert components in rivers downstream of an industrial leak for determining toxicity risks (MINEVIEW project):

- Simulation of a hypothetical 1 tonne of Nickel discharged on the 09/11/2014 into the freshwater ecosystem from Talvivaara

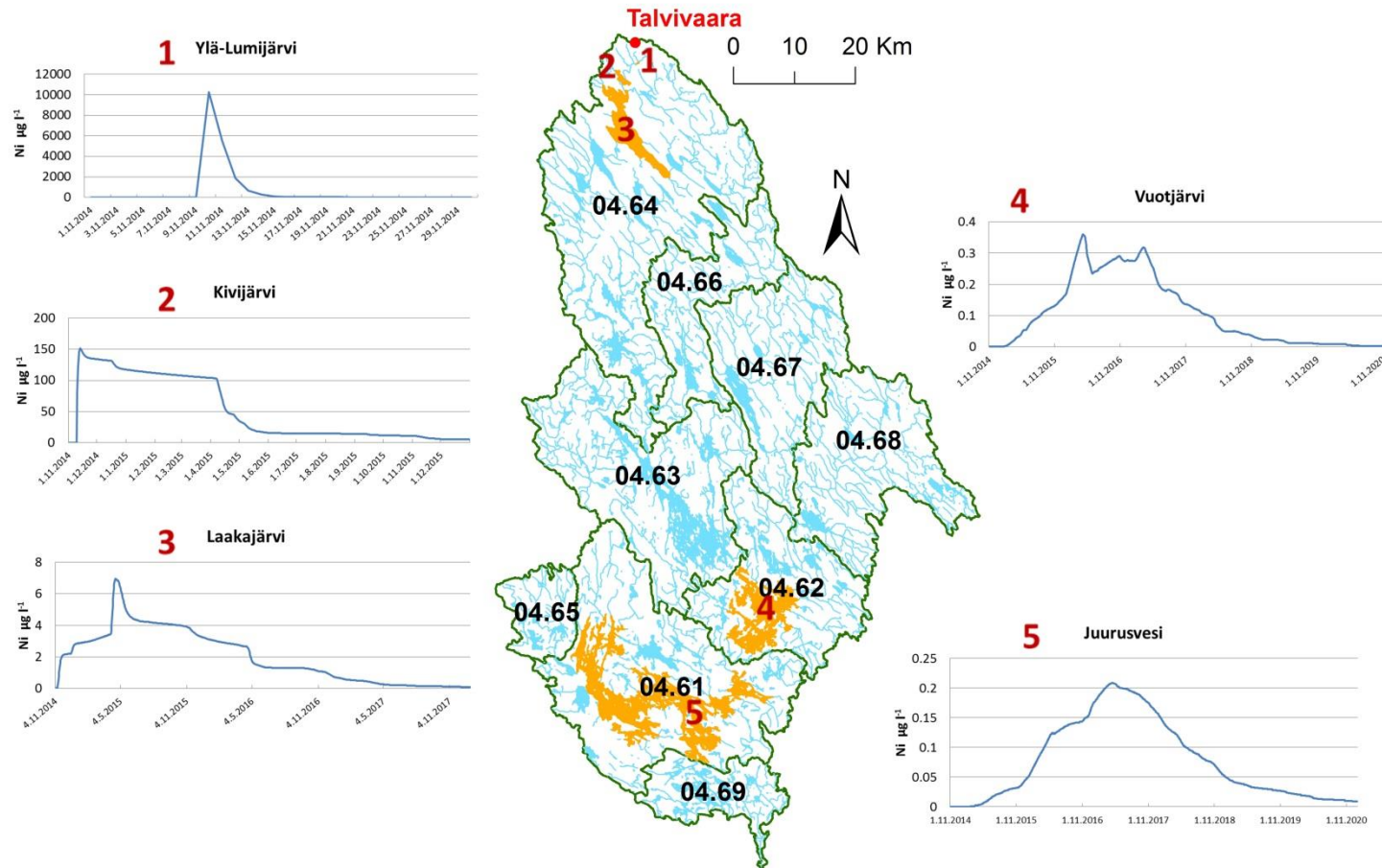

- In real life, regulated lake outflows are decided by regulation operators (human beings making decisions)

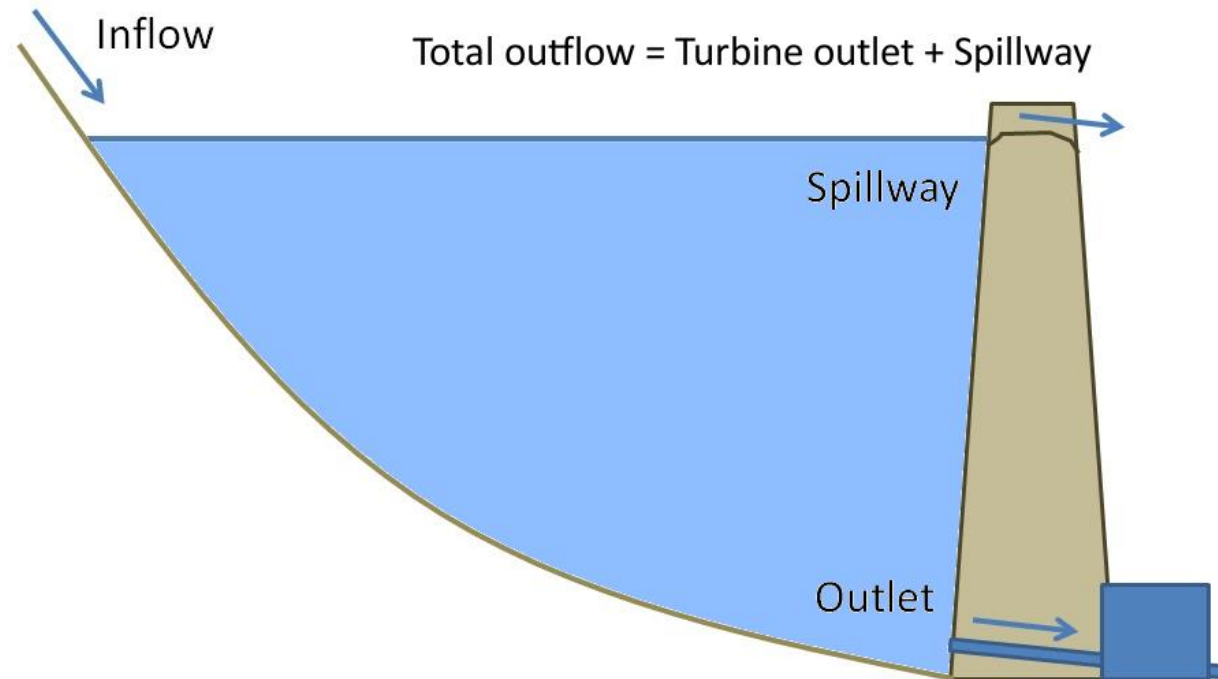

- When forecasting future, it is impossible to know what decisions the real-life operators are going to make in the future
 - We have to "guess" their future decisions, because otherwise we wouldn't be able to make forecasts

- Traditionally in the SYKE Watershed Forecasting and Simulation System, the "guessing" of the future regulation decisions is done with *lake outflow tables* (finnish "säännöstelyohje")
- Lake outflow tables define the outflow based on *water level* and *date*

		Juoksutus			
		2.00	14.00	14.00	16.00
kk	pp	Vedenkorkeus			
1	1	68.80	69.30	69.50	69.70
3	27	68.80	69.15	69.20	69.25
4	1	68.80	69.10	69.20	69.25
4	5	68.80	69.05	69.10	69.50
4	9	68.80	69.30	69.40	69.50

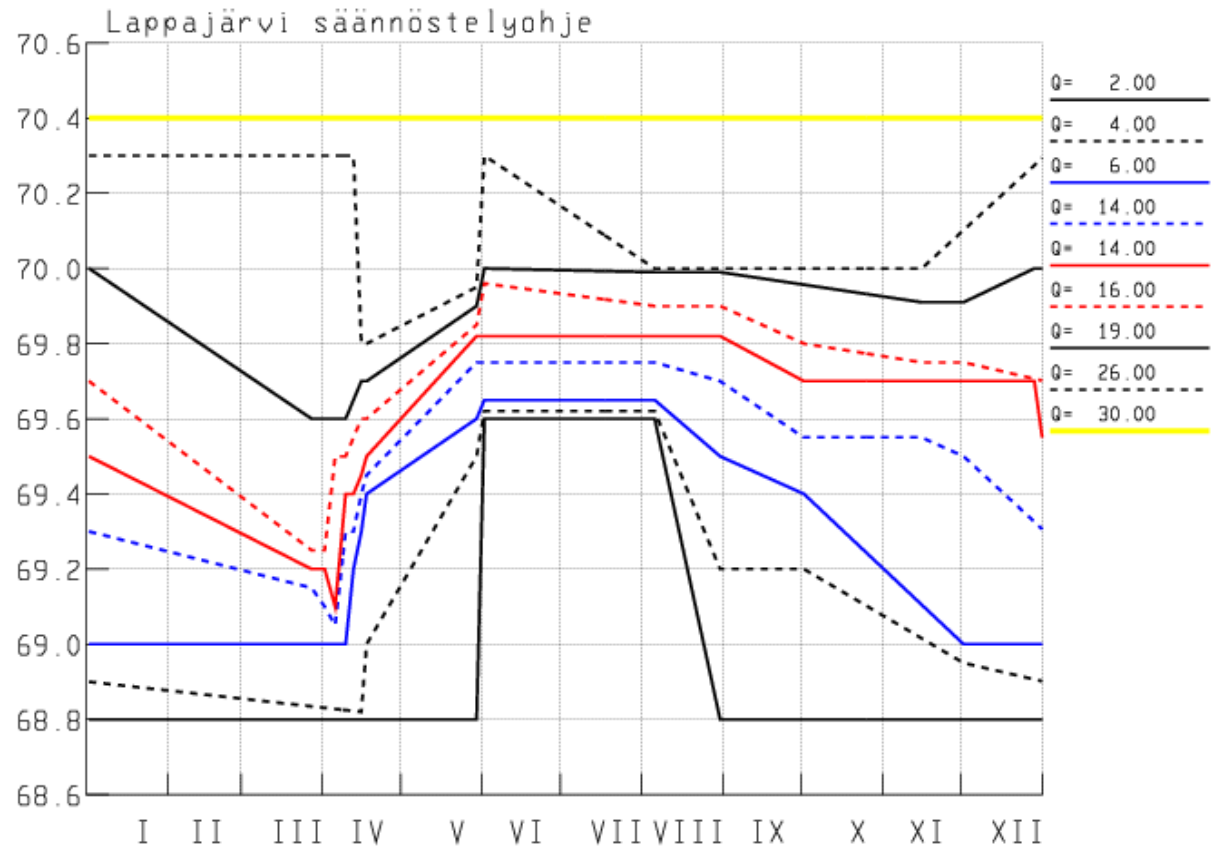

- Forecasting future with lake outflow tables is like *simulating a "blind operator who doesn't look around"*

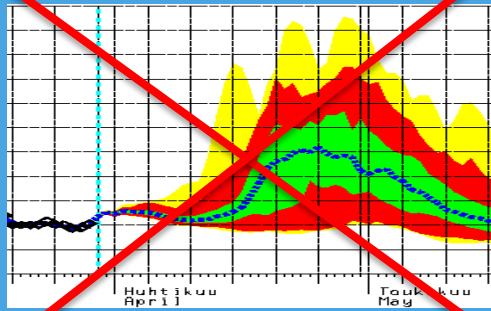

I am not looking current snow situation or weather forecasts, I only look calendar and water level when I decide outflow

WATERSHED SIMULATION AND
FORECASTING SYSTEM
WSFS-VEMALA

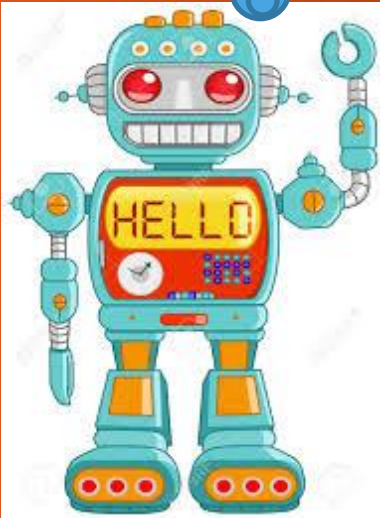

- We *should* simulate operators in the forecasts like this:

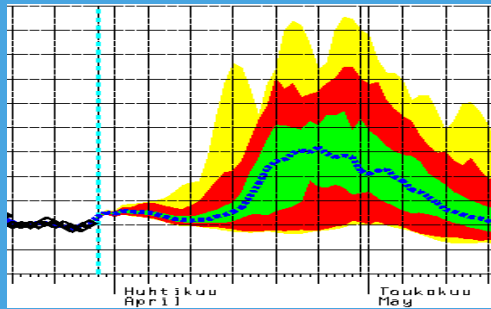

I see there will be great inflow in the future, so I will lower the water level in advance to make room for the flood water

WATERSHED SIMULATION AND FORECASTING SYSTEM WSFS-VEMALA



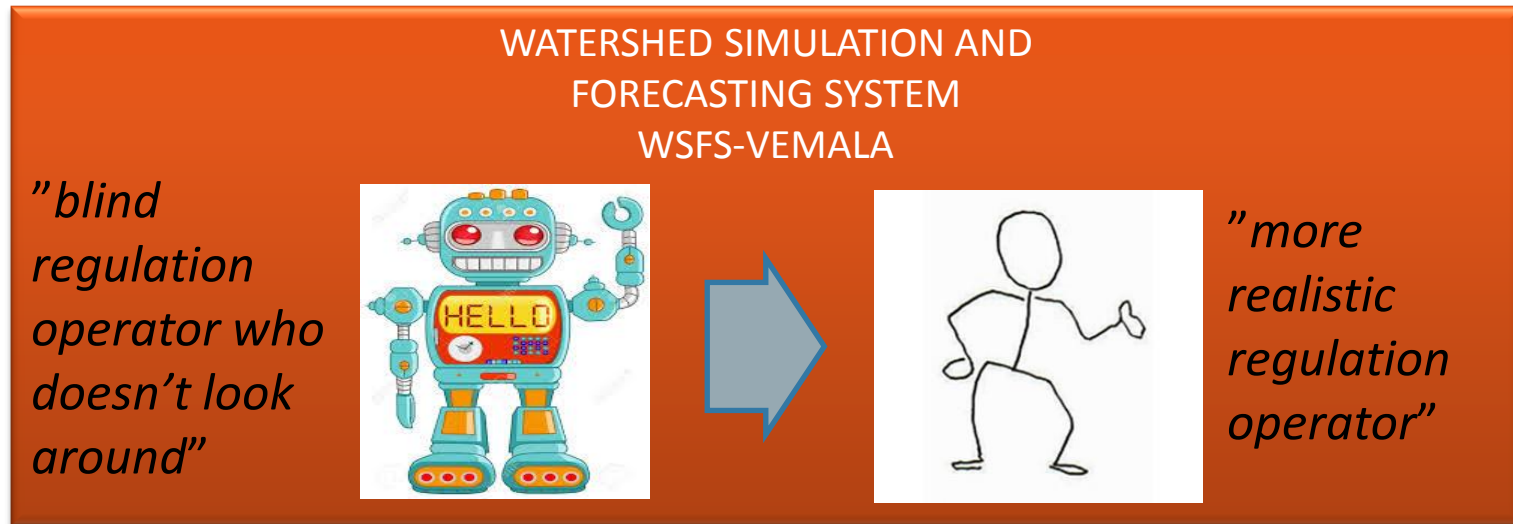

We are developing adaptive lake outflow calculation in order to:

- make better **watershed forecasts**
- make better **simulations** for climate change research, regulation development studies, etc...

How adaptive lake outflow calculation is done? (the next sentences and slides might be difficult to explain so please forgive the presenter all that is not understandable... 😊)

Simulation world is NOT the same thing as real world:

- For example, if today in the real world is January 1st, and we are simulating the period from Jan 1st to Jan 21st, the today of the simulation world can be any day from Jan 1st to Jan 21st.

For one day in the simulation world:

- 1) ONE TIME SERIE of future daily inflows is generated
- 2) One LAKE OUTFLOW TIME SERIE is calculated to match that one inflow time serie
- 3) Lake is simulated for THAT ONE DAY

And for the next day in the simulation world, steps 1-3 are done according to that day.

Generating the time serie of future inflows is not straightforward:

- The today of the simulation world is in the future of the real world
- The future of the simulation world is in the "future of the future" of the real world

And usually we simulate ENSEMBLE instead of just one time serie:

- Ensemble consists of many time series, which are all alike in statistical probability

So how to generate that one time serie of future inflows? The next slide tries to answer..

How to generate appropriate inflow for forecasting horizon of the reservoir operator simulator?

An example: If we are doing forecast today, and in that forecast we are simulating the actions of reservoir operator 2 months ahead from now, how can we generate the artificial forecasting horizon beginning 2 months from now and ending 2 months + N days from now?

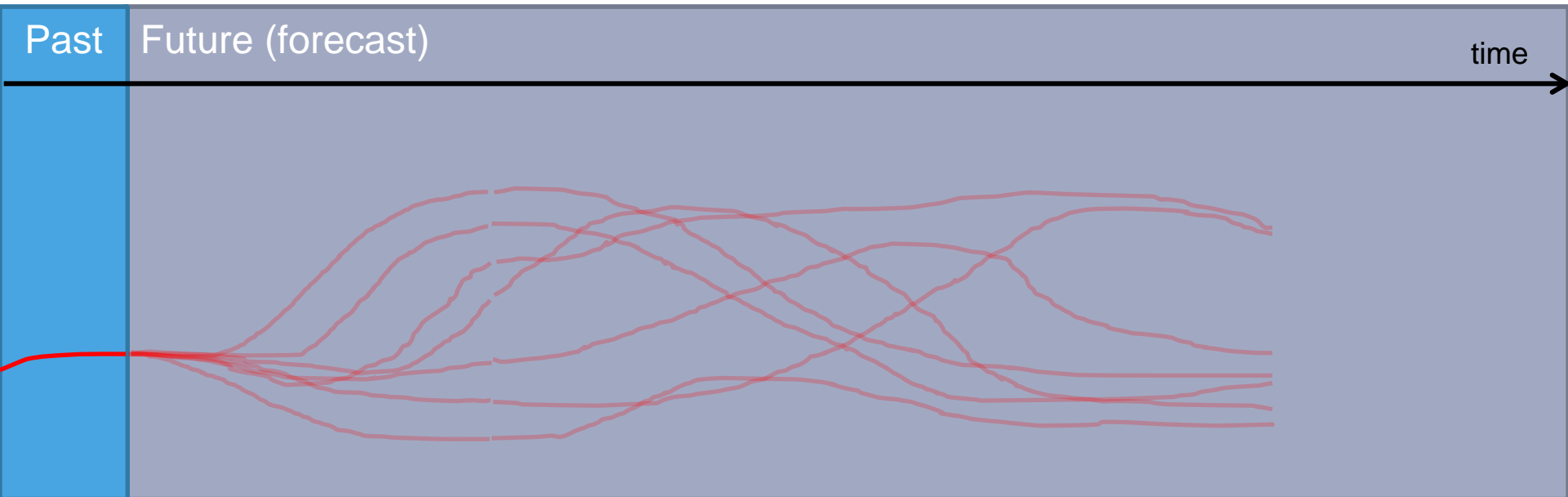

- Forecast ensemble member currently under simulation
- Forecast ensemble member currently not under simulation (other ensemble members)
- Inflow of the current member ("going to happen")
- Inflows of the other members ("not going to happen")
- - - - Generated inflow for forecasting horizon based on current hydrological state (snow water equivalent) and ensemble

Inflow for forecasting horizon is generated as a weighted combination of

- Current ensemble member ("Going to happen")
- Selected ensemble members, which have similar snow water equivalent to current ensemble member
- Median of all ensemble members

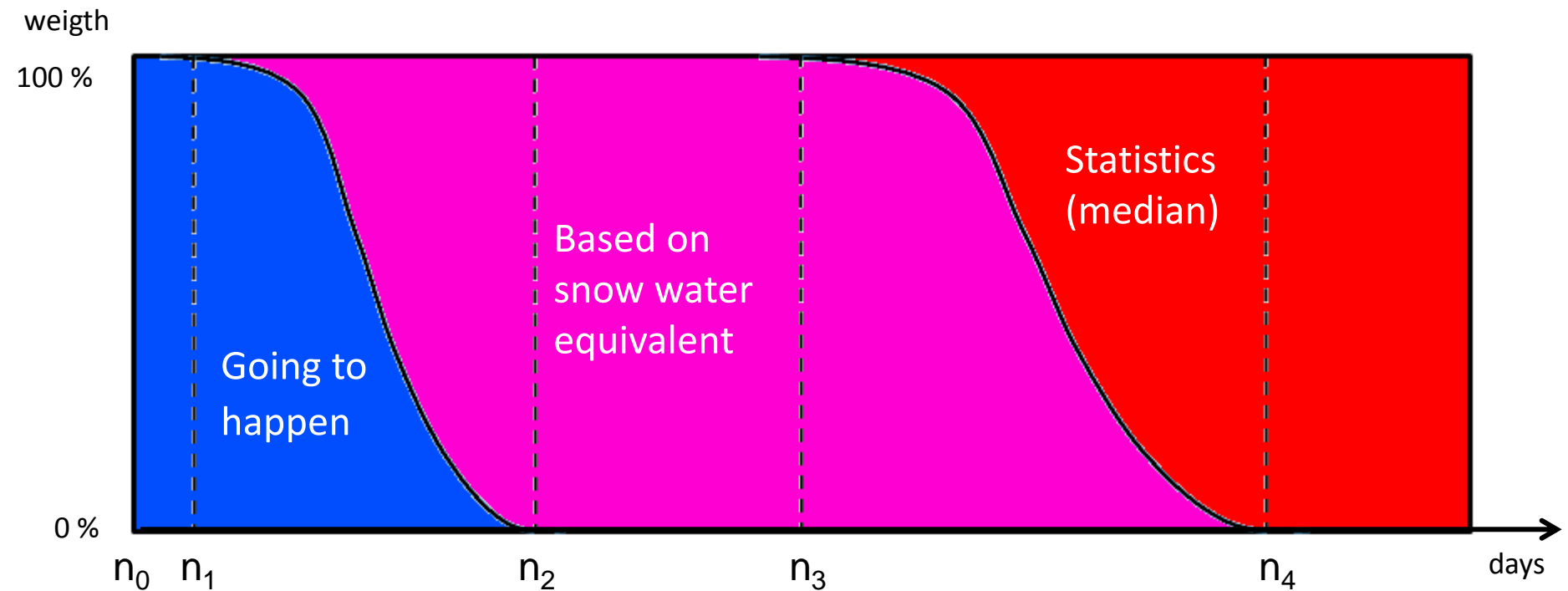

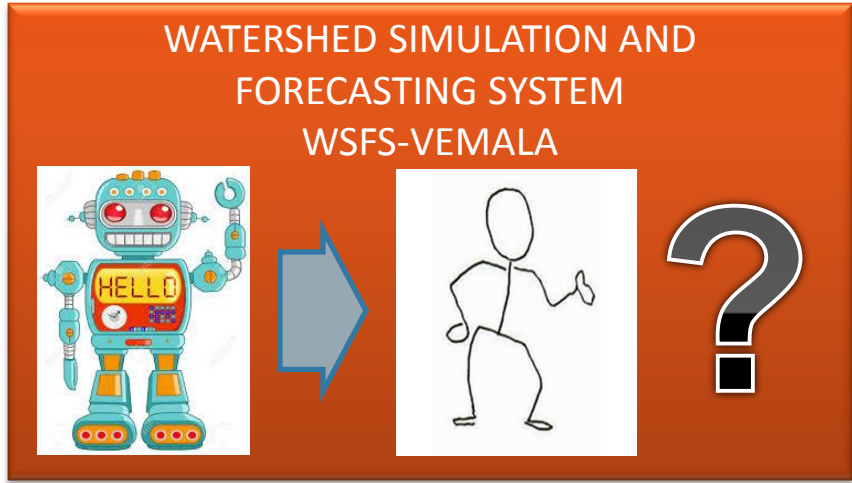

THE PRINCIPLES

1. Acquisition of inflow data
 - o Time series of inflow
2. Calculation of inflow forecast
 - o Current inflow
 - o Regulated inflow
 - o ...
 - o ...
3. Lake simulation and outflow calculation

This is the inflow that WILL HAPPEN in the simulation.

It would be unrealistic to use that inflow as a basis of the outflow calculation, because in real life, the regulator operator DOESN'T KNOW EXACTLY the future inflow.

That's why we must add UNCERTAINTY into the inflow forecast we are using.

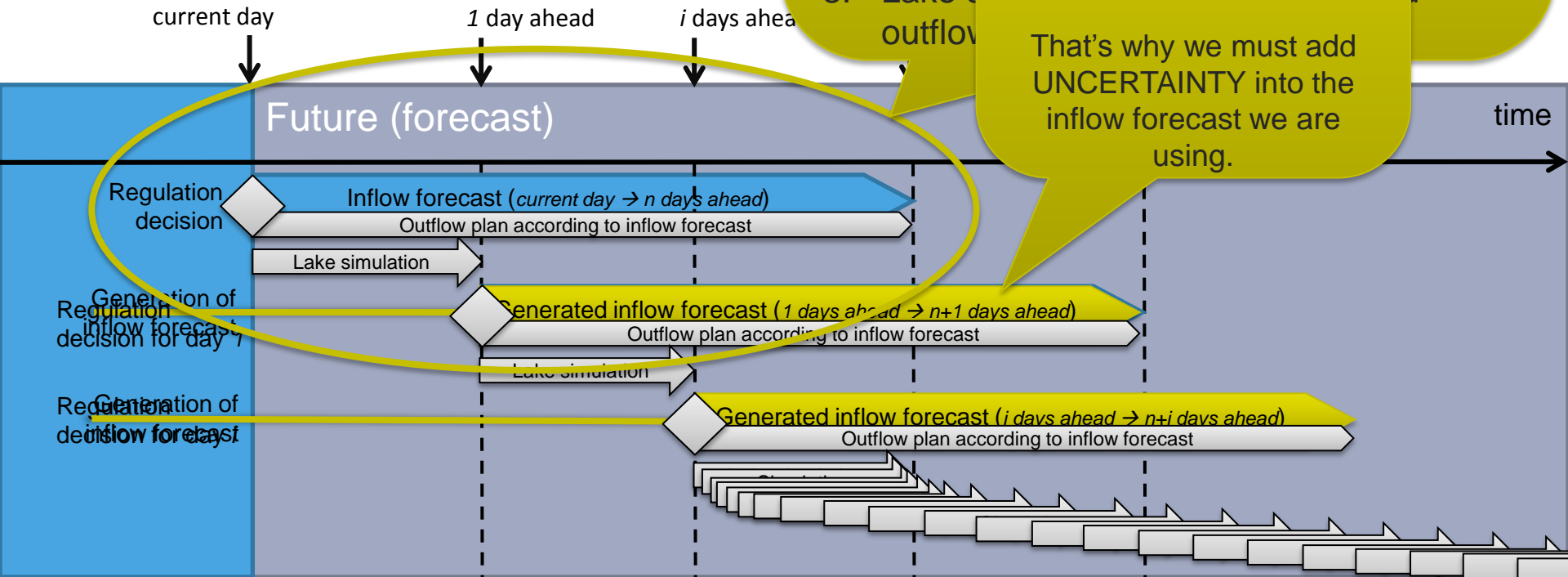

1-hour timestep forecast model

- Simulation time-steps
 - Operative flood forecast model: 1 day
 - Flood forecast model under development: 1 hour
- Reasons for one-hour-time-step development:
 - One-day-time-step is not enough for quick rivers
 - Temperature, precipitation, discharge, ..., they change during the day

→ Using 1 hour time-step is essential for making good forecasts in small rivers with significant changes during day
- Test case: Uskelanjoki watershed
 - Test model is underway for valuation
 - Calibration of model parameters continues
 - Later on: 1 hour time-step for whole country model

Kaukolankoski, Uskelanjoki

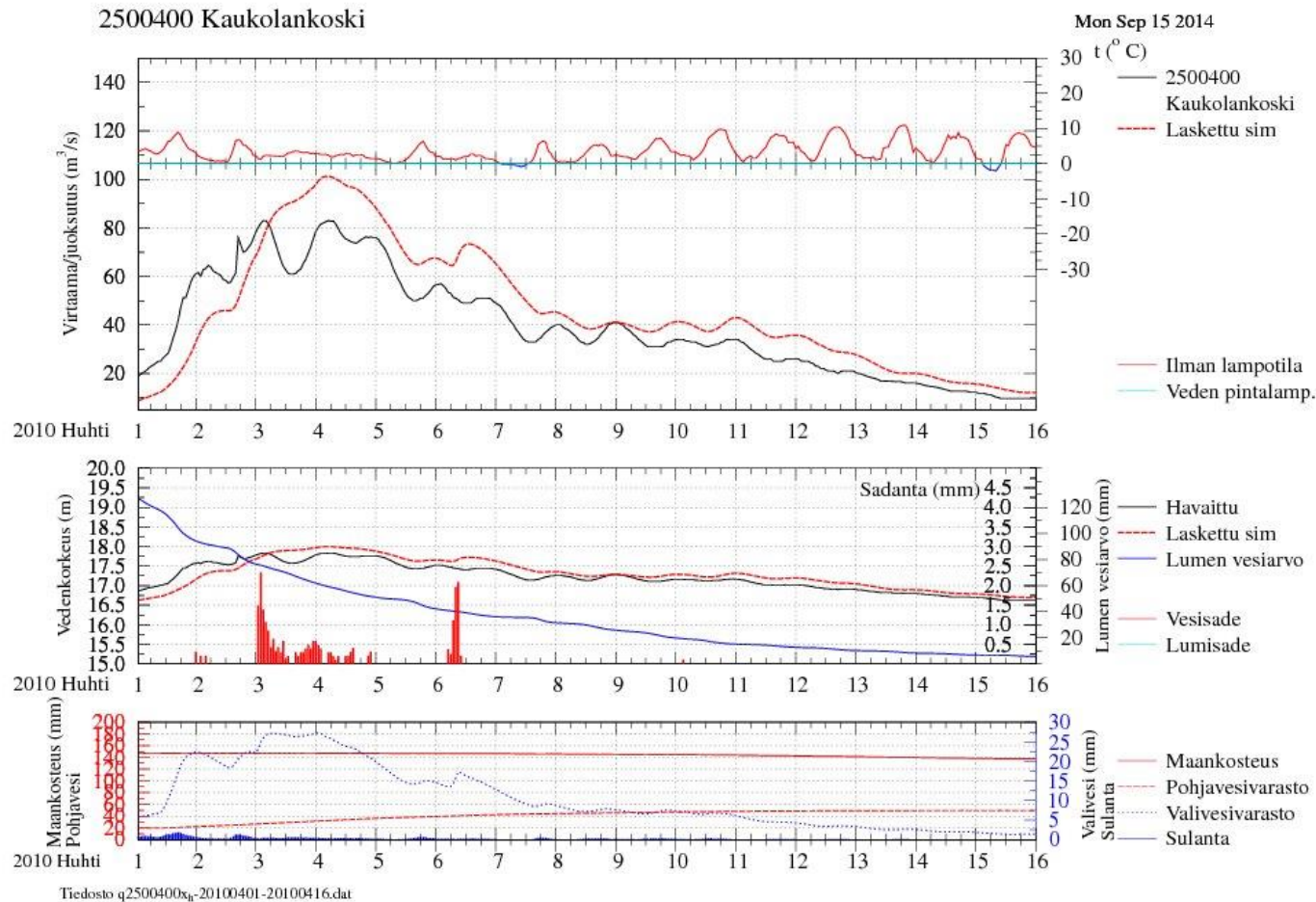

High temporal simulation: 1 h timestep and hourly data

2500400 Kaukolankoski

Tue Sep 16 2014

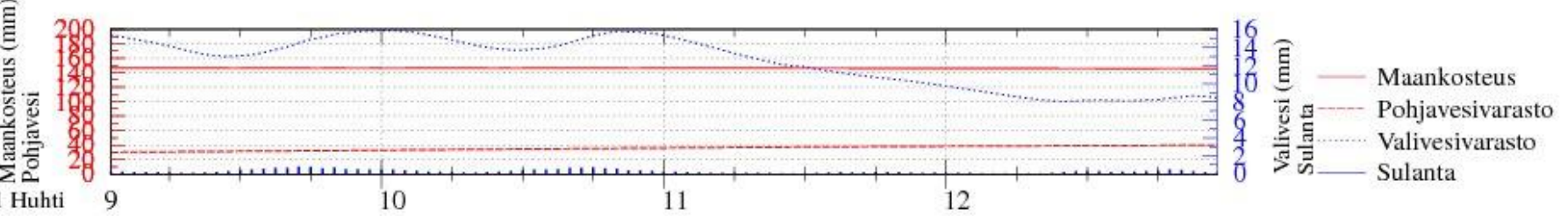
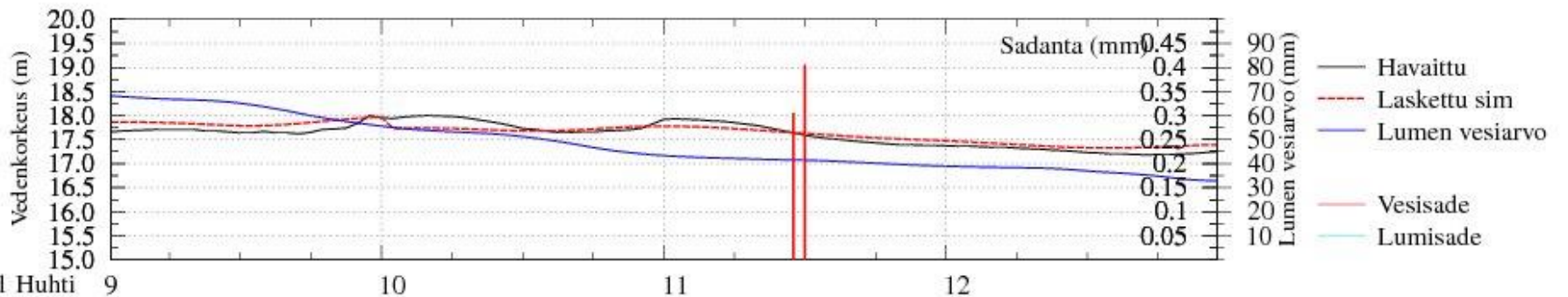
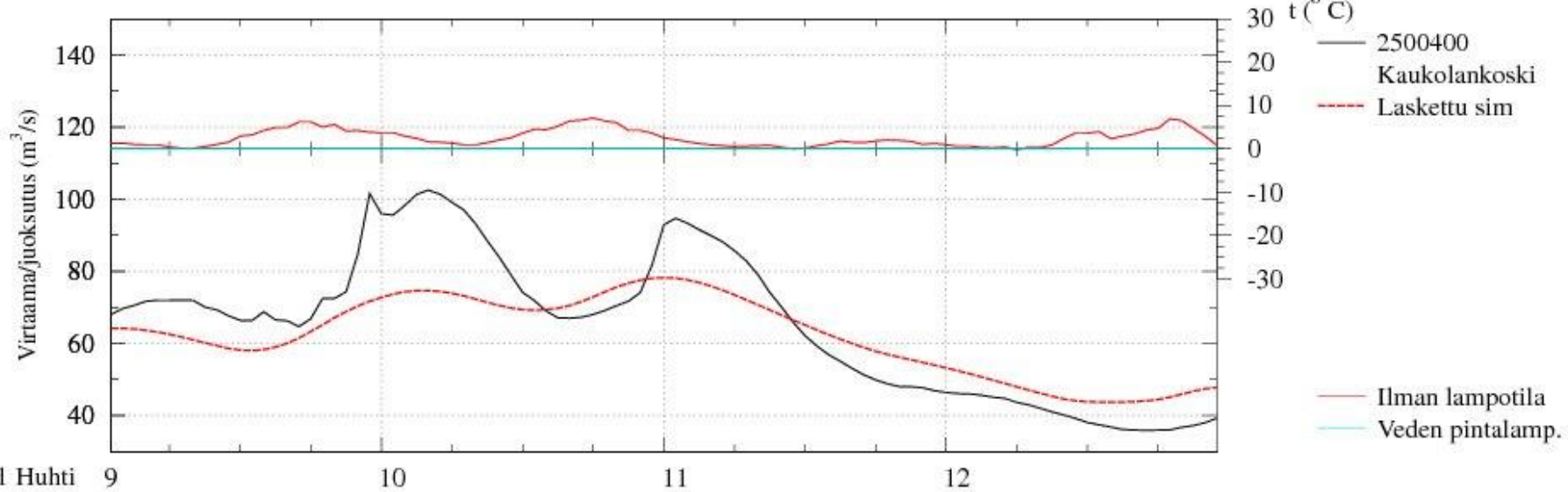

Kaukolankoski, Uskelanjoki

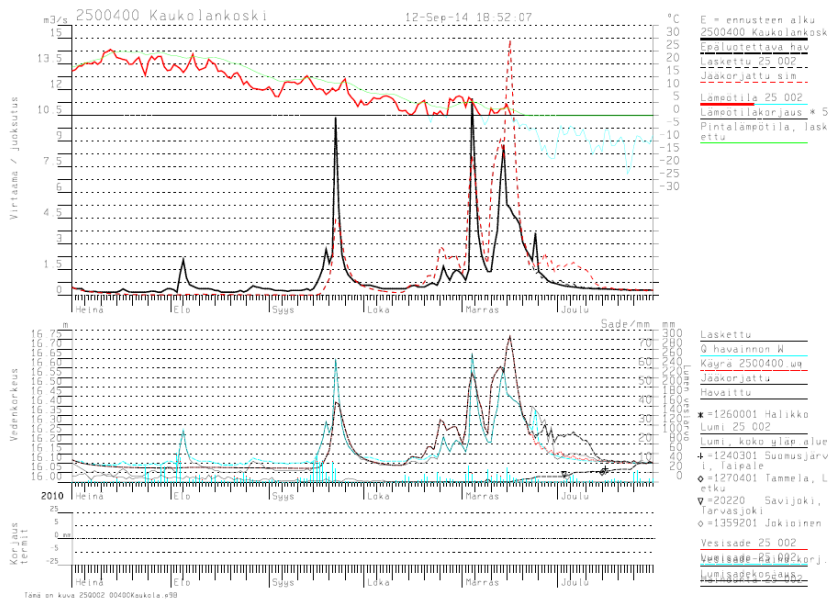

Operational forecast version
Daily values

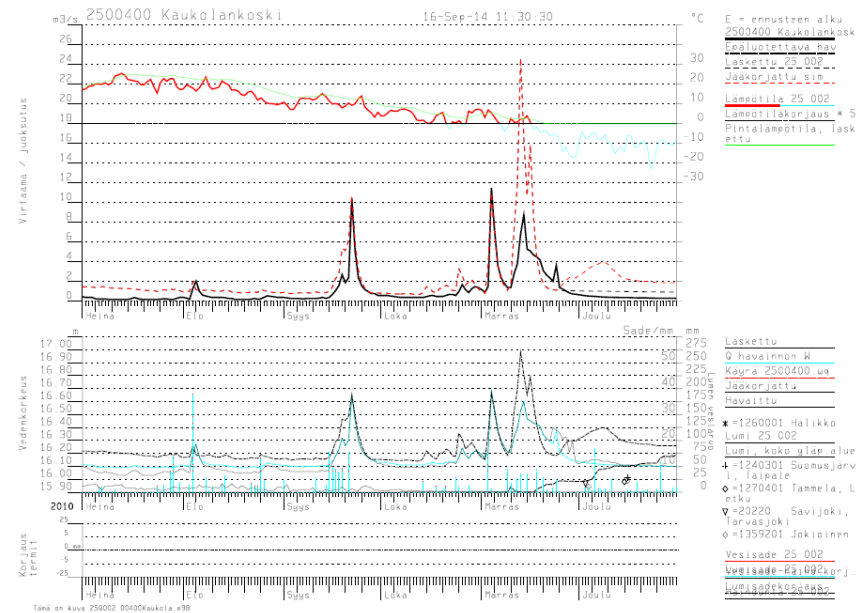

1h timestep version
Daily averages, 1 h simulation step

Temperature and precipitation

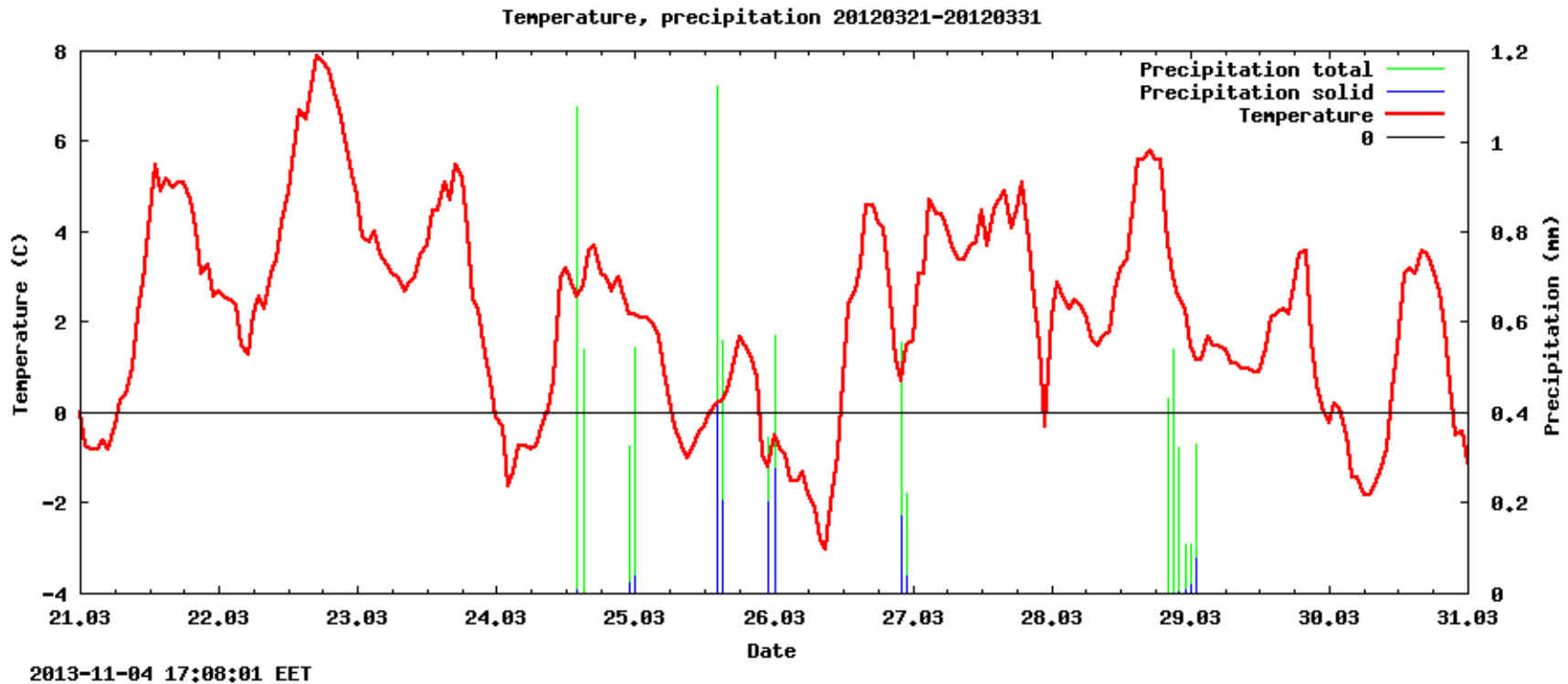

Model input: hourly observations of precipitation (snow, total) and temperature.

Wind effect on precipitation gauge measurements

- Areal precipitation is based on gauge measurements, which have systematic errors due to measurement techniques

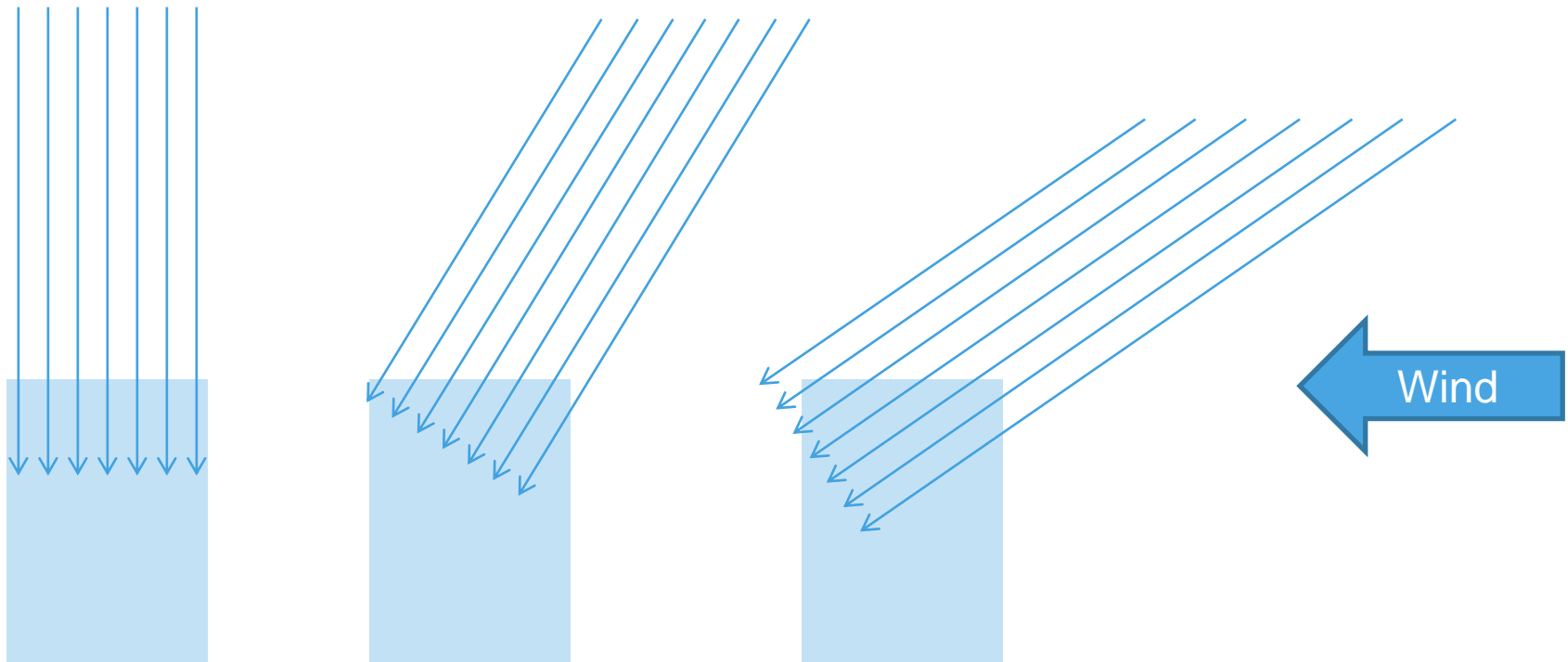

Precipitation Gauge with Nipher Shield



Tretjakov wind shield



Nordic gauges

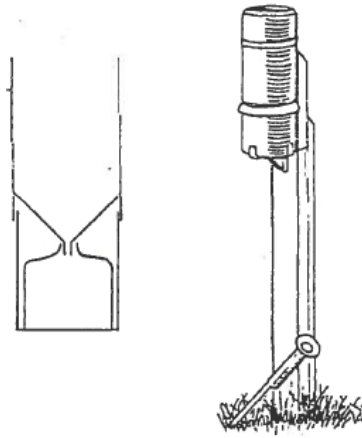

*Gauge 15: Hellmann
(Denmark)*

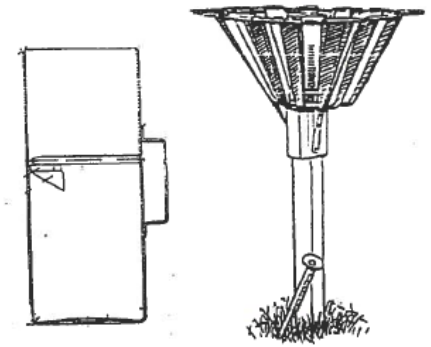

*Gauge 22: Finnish H&H-90
(Finland)*

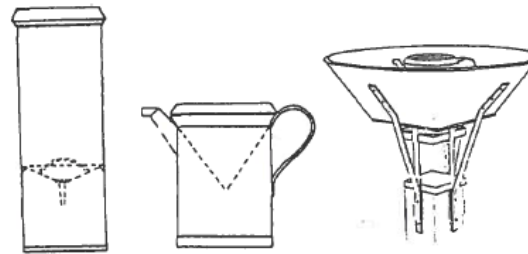

Winter Summer

*Gauge 8: DNMI
(Norway)*

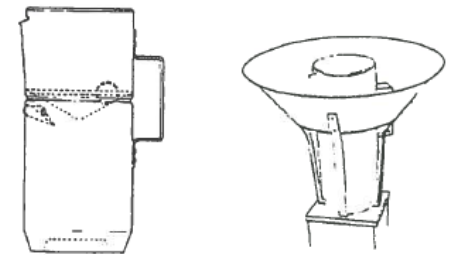

*Gauge 11: SMHI
(Sweden & Norway)*

Alter wind shield



Examples of precipitation gauge catch ratio

- Rain gauge measurements have systematic errors due to measurement techniques
 - Aerodynamic correction
 - Evaporation correction (manual measurements)
 - Wetting correction (manual measurements)
- Annual precipitation correction
 - Snow: at least +20 – +30 %
 - Rain: +3 – +4 %

Examples of precipitation gauge catch ratio

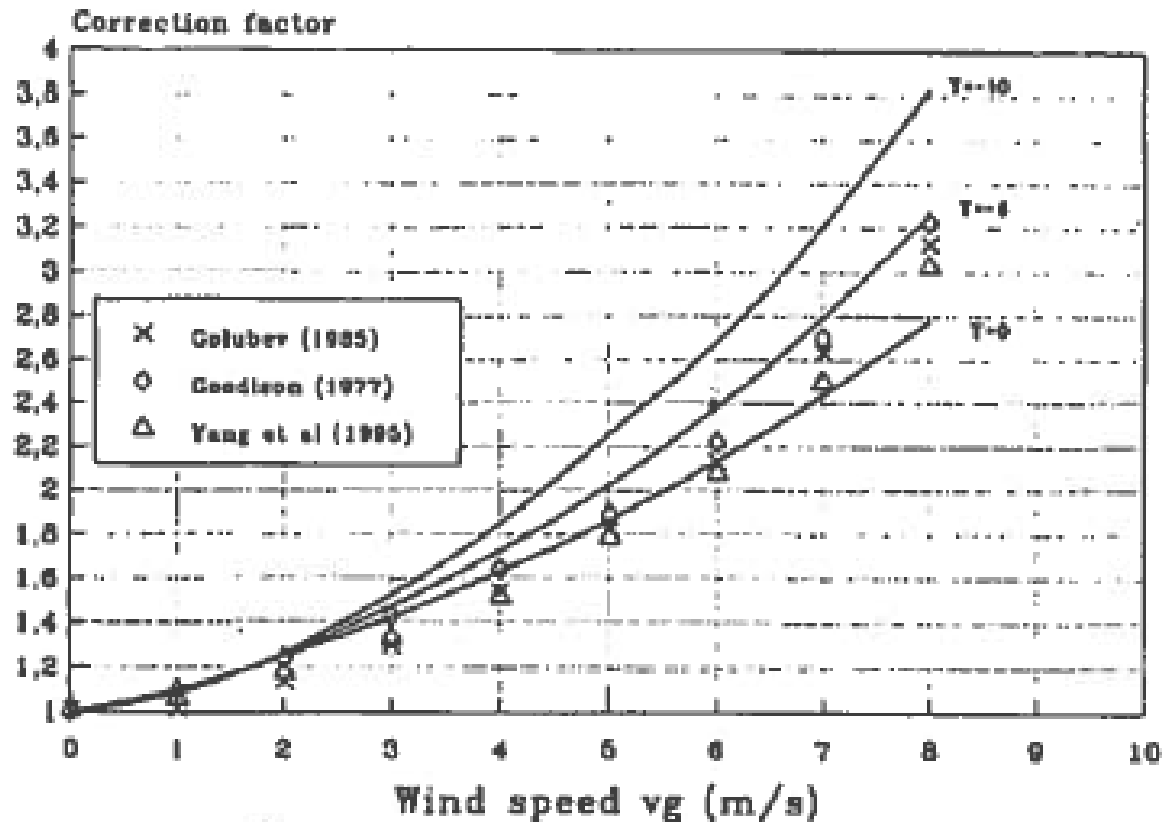

- 3 *Correction factors for solid precipitation in shielded Tretyakov gauge.*
Full drawn lines are based on eq. 4.12. Correction factors for three earlier studies (see also included)

FINNISH H&H-90 GAUGE

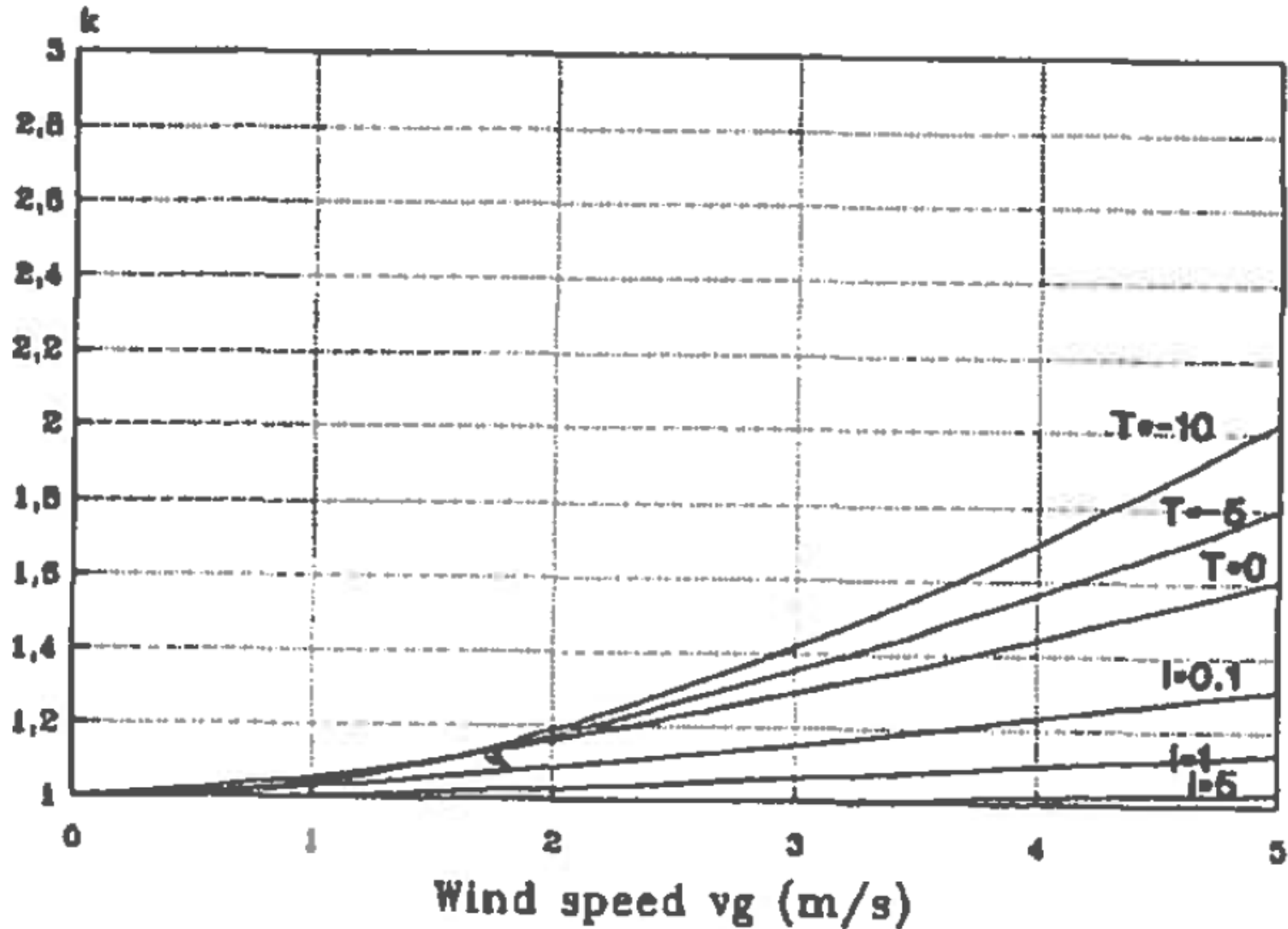

Calculating wind at gauge

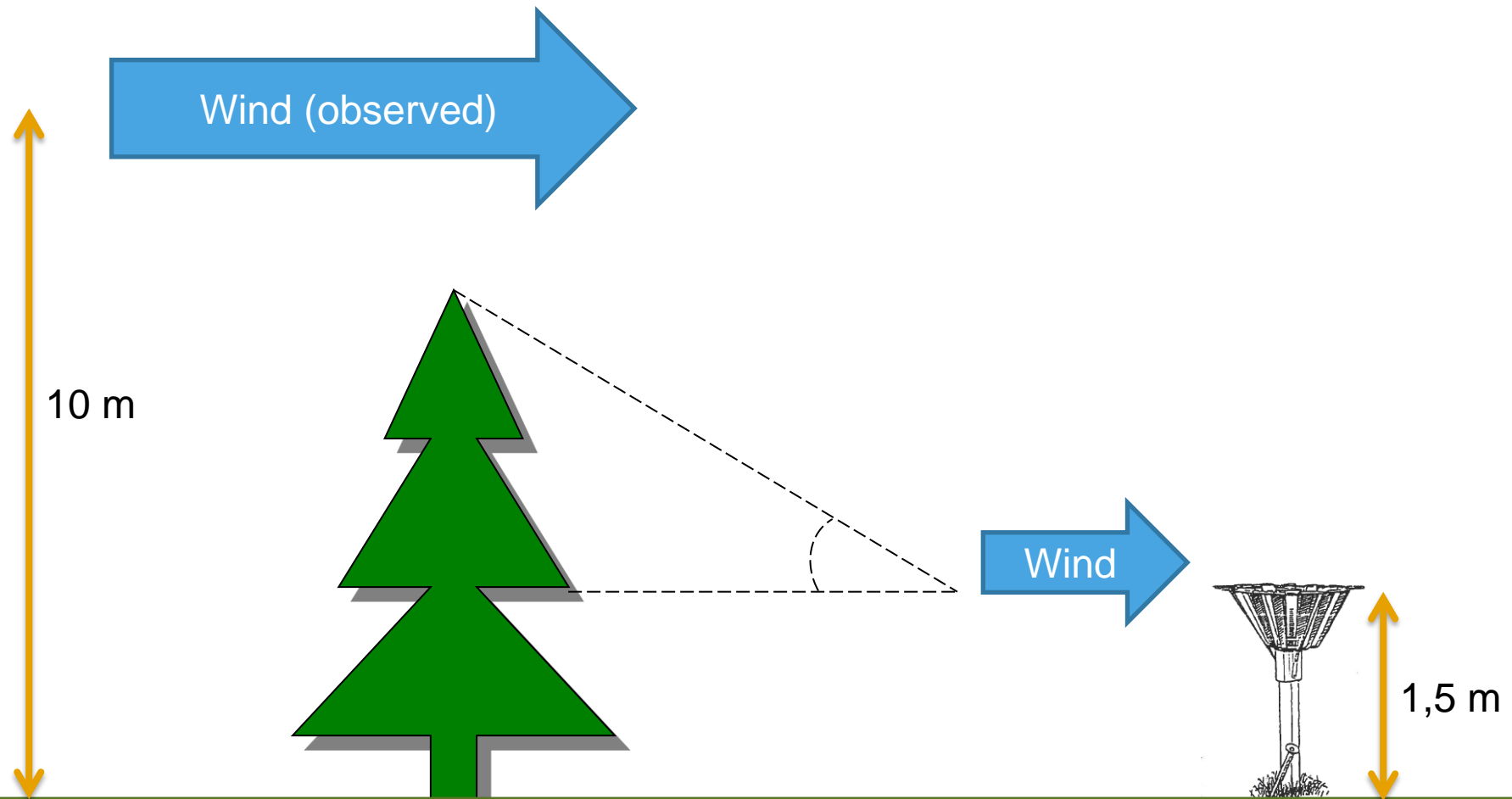

Point-corrected precipitation

- Hourly correction:
 - 1) Calculate wind speed at gauge using interpolated wind data from nearest wind stations and rain gauge site exposure data
 - 2) Determine aerodynamical coefficient for correction by using wind speed at gauge
 - 3) Determine evaporation and wetting loss corrections
 - 4) Calculate precipitation correction from aerodynamical coefficient and evaporation and wetting loss corrections

4.3 Recommended model 1 : "DYNAMIC CORRECTION MODEL".

As stated in chapter 2, the most important ΔP_m terms in the Nordic countries, are evaporation (ΔP_E) and wetting loss (ΔP_w), i.e. eq. (4.1) may be simplified to

$$(4.8) \quad P_c \sim k (P_m + \Delta P_E + \Delta P_w)$$

Aerodynamic coefficient k for snow:

$$(4.12) \quad k_s = \exp[\beta_0 + \beta_1 \cdot v_g + \beta_2 \cdot T + \beta_3 \cdot v_g \cdot T]$$

where v_g is wind speed (m/s) at gauge level and T temperature ($^{\circ}\text{C}$). The constants β_0 , β_1 , β_2 and β_3 have been estimated for the four Nordic gauges, taking into account the correction of the DFIR according to eq. (3.1) of Golubev (see Table 5.6).

Aerodynamic coefficient k for rain:

$$(4.11) \quad k_r = \exp[-0.00101 \cdot \ln I - 0.012177 \cdot v_g \cdot \ln I + 0.034331 \cdot v_g + 0.007697 + c]$$

depending on gauge coefficient c (unshielded gauge $c=0.0$, shielded gauge $c=-0.05$), windspeed v_g (m/s) measured at gauge level and rain intensity I (mm/h).

v_g

The wind speed (v_g) should preferably be measured at the level of the gauge orifice. If wind speed is measured at another level, WMO (1994) states: The reduction of wind speed to the level of the gauge orifice should be made according to the following formula:

$$(4.10) \quad v_g = (\log h z_0^{-1}) \cdot (\log H z_0^{-1})^{-1} \cdot (1 - 0.024\alpha) \cdot v_H$$

where

v_g = wind speed (m/s) at the level of the gauge orifice

h = height (m) of the gauge orifice above the ground

z_0 = roughness length (m): 0.01 m for winter and 0.03 m for summer

H = height (m) of the wind speed measuring instrument above the ground

v_H = wind speed (m/s) measured at the height H above the ground

α = average vertical angle (degrees) of obstacles around the gauge

 v_H

- Based on 3 nearest representative observations
- Distance weighted mean

Talvisateet

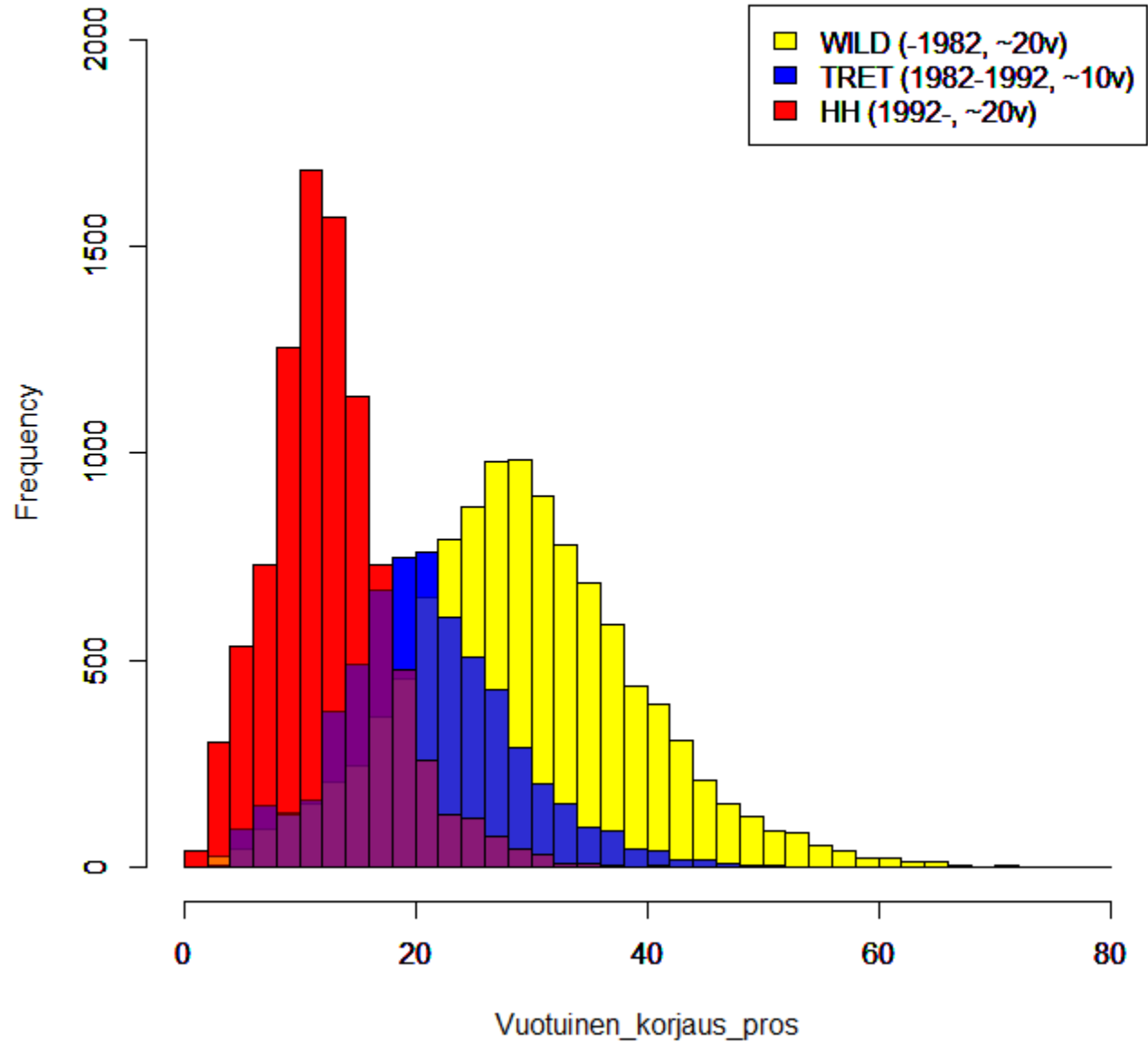

Kesäsateet

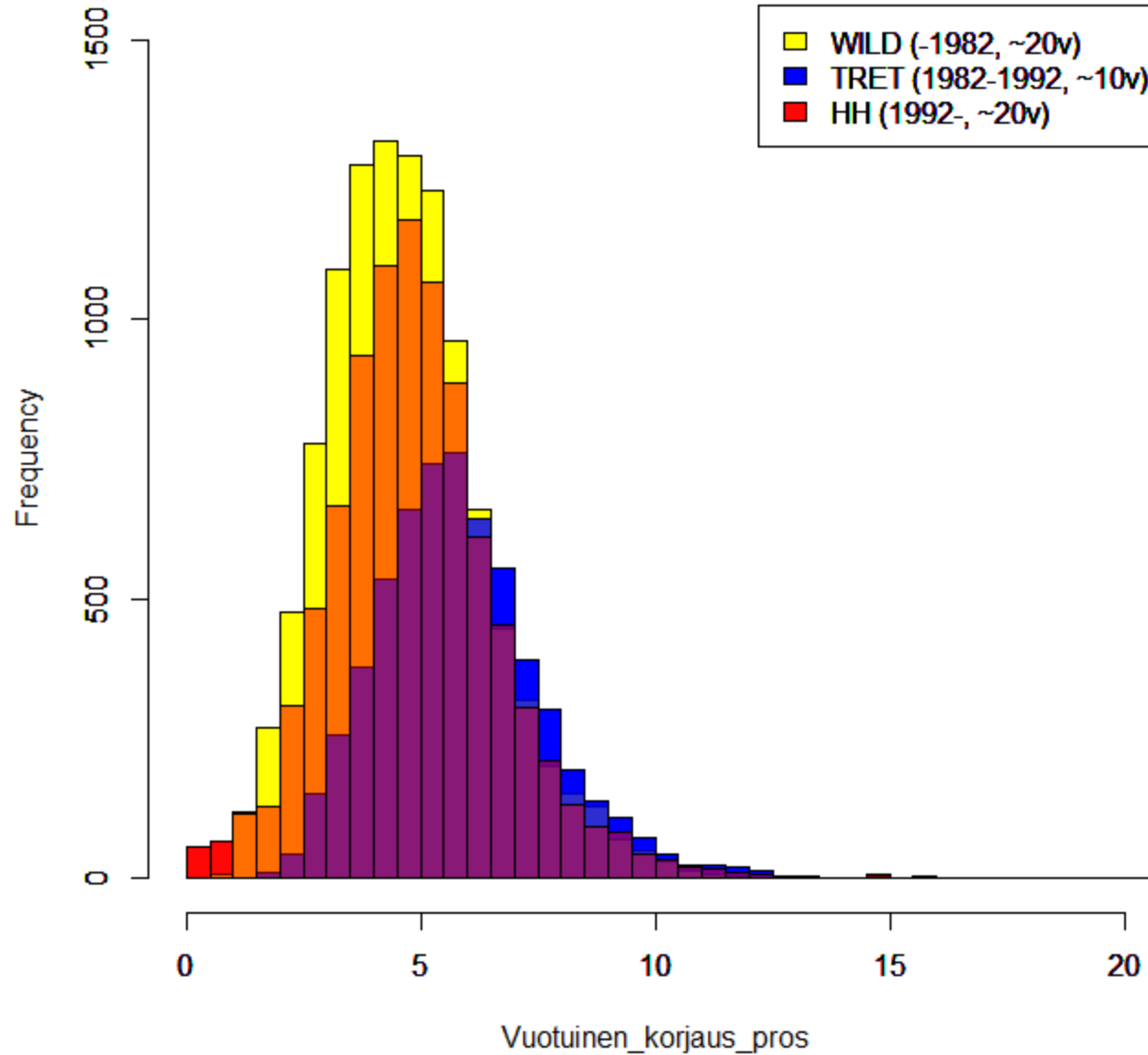

Uusi potentiaalisen haihdunnan prosessimalli

- Potentiaalisen haihdunnan määrittäminen Class A-havainnon sijasta Penmanin menetelmällä laskemalla

- Kaava:
$$E_p = \frac{\Delta}{\Delta + \gamma} (R_n) + \frac{\gamma}{\Delta + \gamma} \frac{6,43(1 + 0,536U_2)D}{\lambda}$$

- Jossa Δ = kulmakerroin vesihöyryn kyllästyspaine – lämpötila –käyrälle
- γ = psykometrivakio
- λ = veden höyrystymisen latenttilämpö
- R_n = nettosäteily
- U_2 = tuulen nopeus 2 m:n korkeudella
- D = vesihöyryn painevaje
- Lähtötietoina lämpötila (T), pilvisuus (Cl), tuulen nopeus (Ws), ilman suhteellinen kosteus (U), ilmanpaine (Ba) ja sijainti
 - Havainnot Ilmatieteen laitoksen havaintoasemilta
- Hyötynä laskenta myös alkukeväisin, loppusyksyisin ja talvisin, jolloin Class A-havainnoja ei ole, sekä tarkempien lähtötietojen ja ennustesuureiden käyttö

Kalibrointi Class A –havaintoja vastaan

- Pitkääaltosäteilyn laskennassa käytettävät parametrit (2 kpl) kalibroitu Class A –haihduntahavaintoja vastaan kullekin havaintoasemalle
- Kalibroinnin tuloksena saadut hyvyysluvut haihdunta-aseuille ovat vaihtelevia, välillä 0,19 - 0,83, suurin osa kuitenkin parempia kuin 0,6
- Huonoimmat hyvyysluvut saaneet asemat (Sodankylä Vuotso II, Suomussalmi, upotettu Class A) tarkastellaan erikseen ja ainakin Suomussalmen asema hylätään
- Havaintoasemille kalibroidut parametrit levitetty muille alueille interpoloimalla -> koko Suomen kattava laskenta

**Potentiaalisen haihdunnan päiväarvoja nykymallilla
(Class A –havainto käytössä, yksinkertaisella kaavalla
laskettu kun ei ole havaintoa) ja Penmanin menetelmällä
laskettuna**

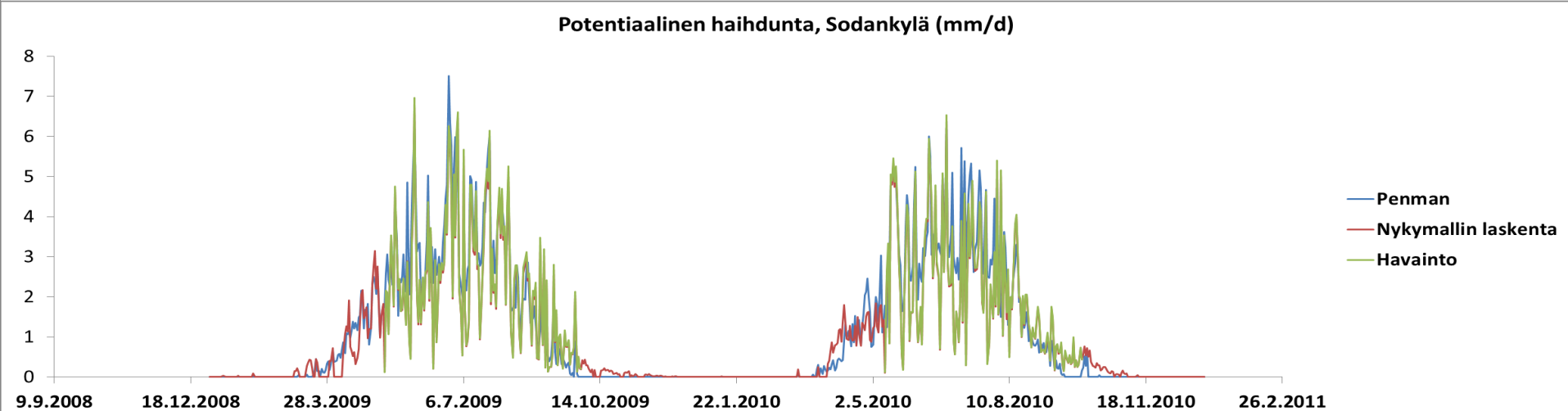
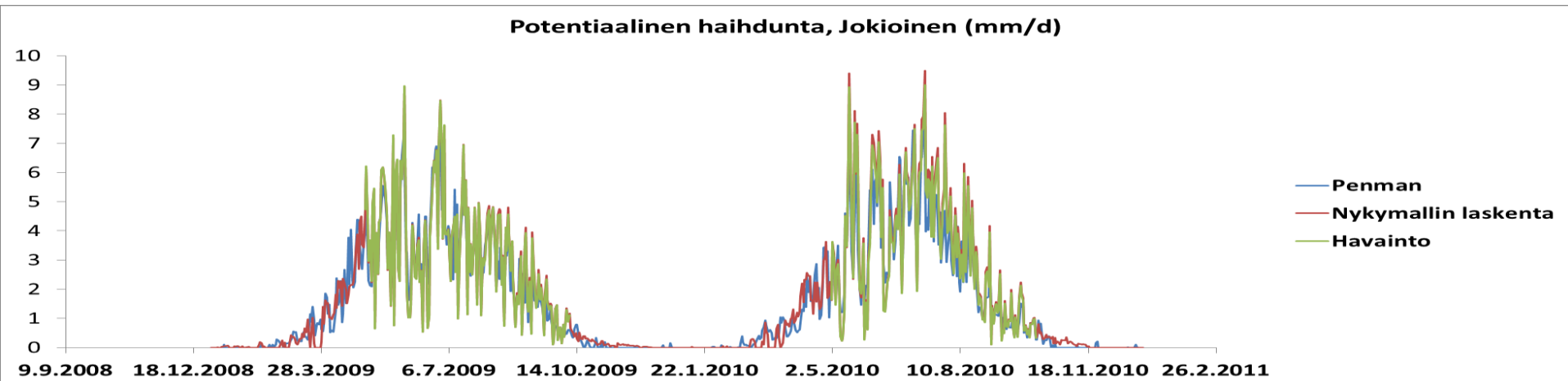

Ruukin Class A -asema:

Potentiaalinen haihdunta, Ruukki (mm/d)

— Penman
— Havainto

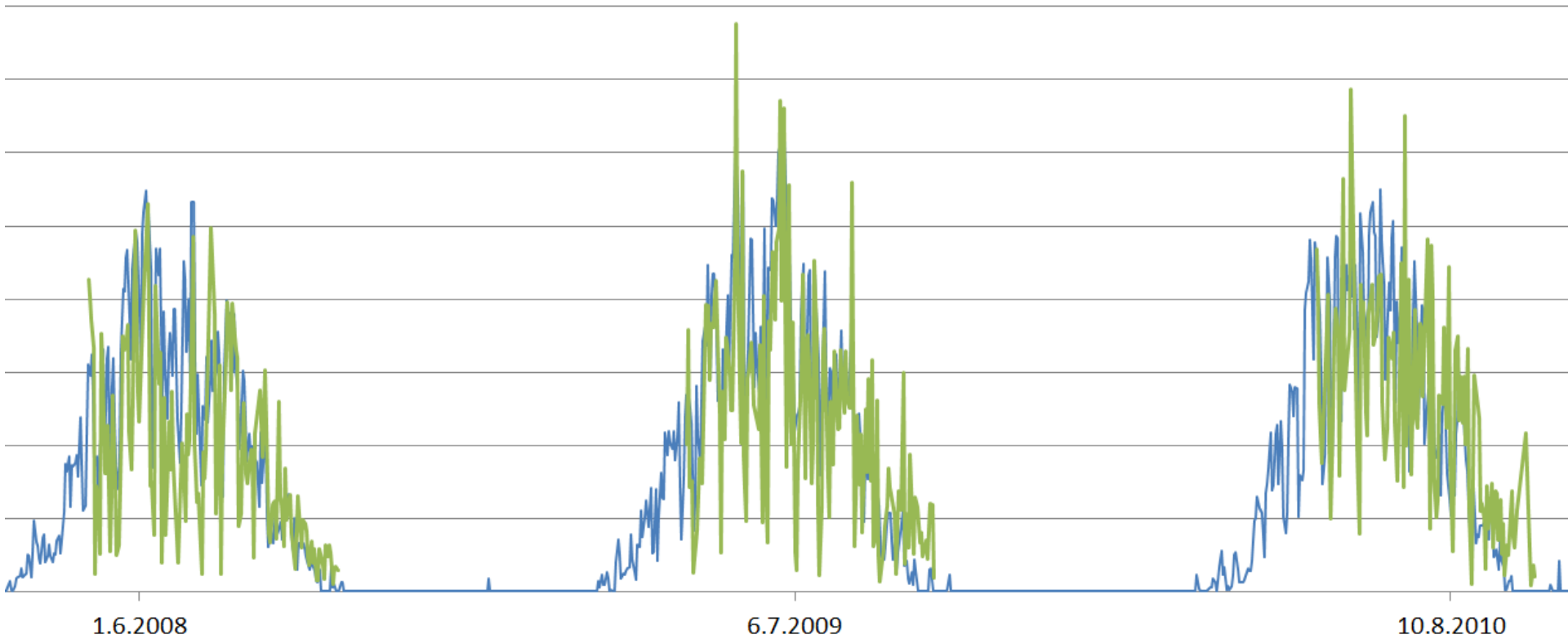

Vuosien 2001-2010 keskimääräinen potentiaalinen vuosihaihdunta

Nykymalli

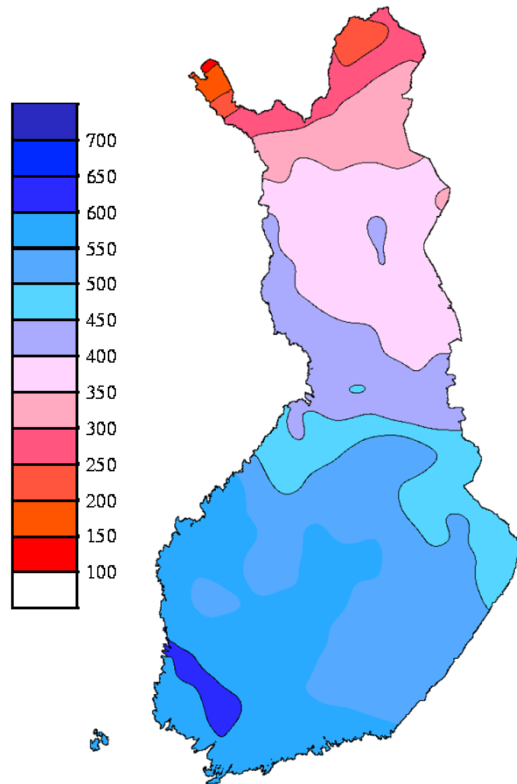

Keskim. vuoden potentiaalinen haihdunta 2001-2010 28.12.2010
Forecast day 31.12.
Mean annual potential evaporation 2001-2010 (mm/ye 28.12.2010)

Penmanin menetelmä

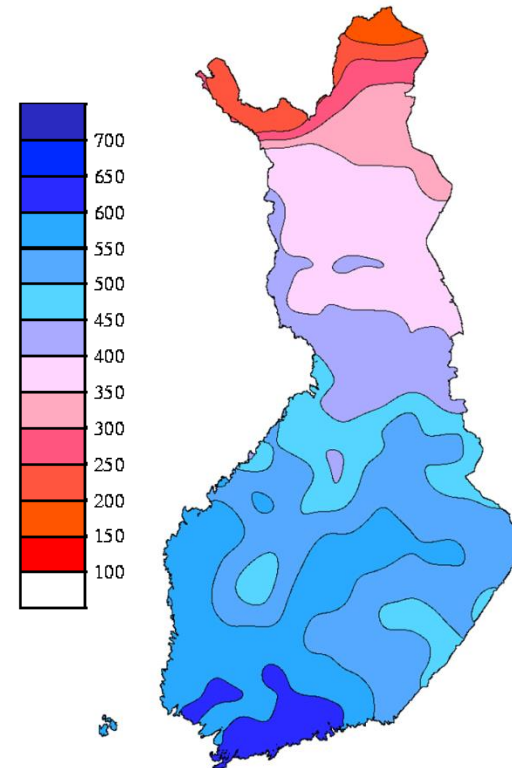

Keskim. vuoden potentiaalinen haihdunta 2001-2010 28.12.2010
Forecast day 31.12.
Mean annual potential evaporation 2001-2010 (mm/ye 28.12.2010)

Jatkokehitys

- Uuden kehitetyn mallin testaus / kalibrointi ja käyttöönotto
- Mahdollisesti tuntilaskentaan siirtyminen
- Todellisen haihdunnan laskennan kehitys
 - Tavoitteena eri kasvillisuustyypien ja mahdollisesti interseption huomioon ottaminen sekä maaperän ja maankäytön paikkatietoaineiston hyödyntäminen
 - Mahdollisesti Penman-Monteithin kaavan käyttö matalalle kasvustolle sekä puustolle
 - Maankosteuden rajoittava vaikutus huomioidaan
- Nykyisin maahaihdunta lasketaan potentiaalisesta haihdunnasta maankosteuden vajauksen ja kalibroittavien parametrien avulla

Kasvillisuushaidunnan laskennan kehitys

- Potentiaaliselle haihdunnalle kehitetty malli pohjana -> laajennettu Penman-Monteithin yhtälöksi tietylle referenssikasville (Handbook of Hydrology)
- Kasvillisuustyyppi huomioidaan kasvukauden mukaan vaihtelevan kasvillisuuskerroimen avulla
- Maankäyttötiedot käytössä (6 luokkaa)
- Metsissä lasketaan myös interseptio
- Tarvitaan lisäksi rajoittavia tekijöitä mm. maankosteus
- Nykyisin maahaidunta lasketaan potentiaalisesta haihdunnasta maankosteuden vajauksen ja kalibroittavien parametrien avulla

- Potentiaalisen haihdunnan määrittäminen Class A-havainnon sijasta Penmanin menetelmällä laskemalla

- Kaava:
$$E_p = \frac{\Delta}{\Delta + \gamma} (R_n) + \frac{\gamma}{\Delta + \gamma} \frac{6,43(1 + 0,536U_2)D}{\lambda}$$

- Jossa Δ = kulmakerroin vesihöyryn kyllästyspaine – lämpötila –käyrälle
- γ = psykometrivakio
- λ = veden höyrystymisen latenttilämpö
- R_n = nettosäteily
- U_2 = tuulen nopeus 2 m:n korkeudella
- D = vesihöyryn painevaje

- Lähtötietoina lämpötila (T), pilvisuus (Cl), tuulen nopeus (Ws), ilman suhteellinen kosteus (U), ilmanpaine (Ba) ja sijainti
 - Havainnot Ilmatieteen laitoksen havaintoasemilta
- Hyötynä laskenta myös alkukeväisin, loppusyksyisin ja talvisin, jolloin Class A-havainnoja ei ole, sekä tarkempien lähtötietojen ja ennustesuureiden käyttö (tuntilaskenta, ilmastonmuutos)

Kasvillisuushaidunnan prosessimalli

- Kullekin maankäyttöluokalle:

$$E = K_s(\theta) K_{co} E_{rc} \quad (\text{mm/vrk})$$

E_{rc} = referenssikasvin haihdunta

K_{co} = kasvillisuuskerroin

$K_s(\theta)$ = maankosteuden rajoittava vaikutus

- Kasvillisuuskerroin koostuu kasvikohtaisesta lämpösumman laskennasta ja kasvin koosta verrattuna referenssikasviin
 - Lämpösumman eli kasvukauden vaikutus lasketaan erikseen pellolle, suolle ja lehtimetsälle
 - Havumetsässä, rakennetulla alueella ja vesialueella kasvukauden vaikutusta ei huomioida

Maankosteuden vaikutus haihduntaan

- Maankosteudelle testattu nykyiseen vesistömalliversioon pohjautuvaa laskentaa sekä kehitteillä olevaa tarkempaa maankosteuden kaksikerrosmallia
- Vesistömallin parametreihin ja laskentaan perustuva vaikutus
= Neliöjuuri(maankosteus / maavesivaraston koko)
(huom. sama vaikutus koko vesistön 3 jv. alueella)
- Kaksikerrosmalli ottaa huomioon erilaisten maannosten osuudet 3 jv. alueella ja niiden vaikutuksen maankosteuteen
 - Maankäyttö- ja maaperäluokat yhdistelty paikkatieto-ohjelmalla Aurajoen vesistölle
 - Yhdistelmäluokkia testataan malliversiossa, jossa on yhdistetty maankosteuden kaksikerrosmalli ja kasvillisuushaihdunnan uusi laskentamalli

Maahaihdunta kasvillisuusluokittain Aurajoella, mm (huom. tässä kaikilla sama maankosteus)

Rakennettu alue, %	1.4
Vesi	0.01
Pelto	33.69
Suo, vähäpuustoinen alue	19.03
Havumetsä, räme, havukorpi	10.32
Lehtimetsä, lehtikorpi, sekametsä	35.55

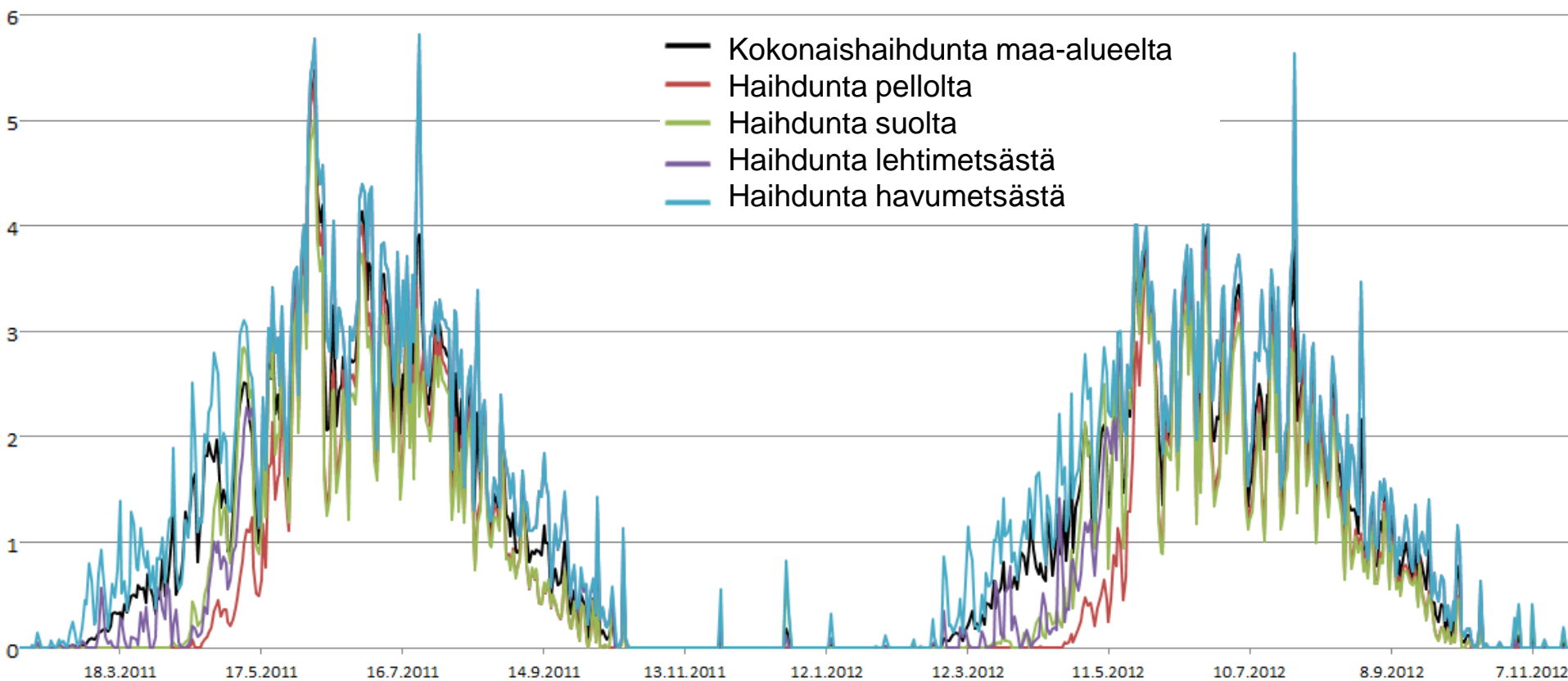

Yhdistelmämallin laskentatuloksia

Haihdunta Hypöistenkoski kokoalue 2013

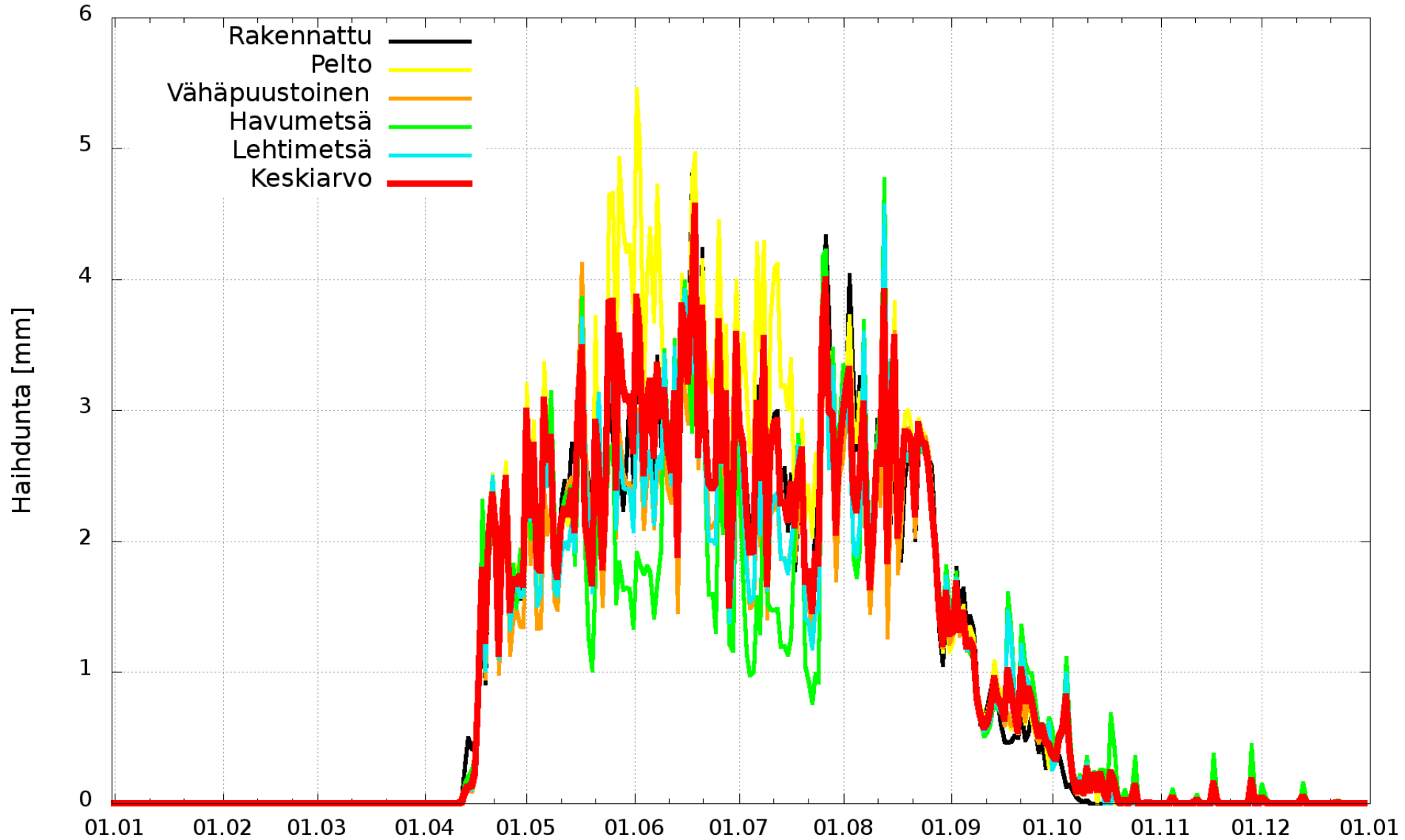

Yhdistelmämallin laskentatuloksia

Haihdunta Hypöistenkoski kokoalue 2013

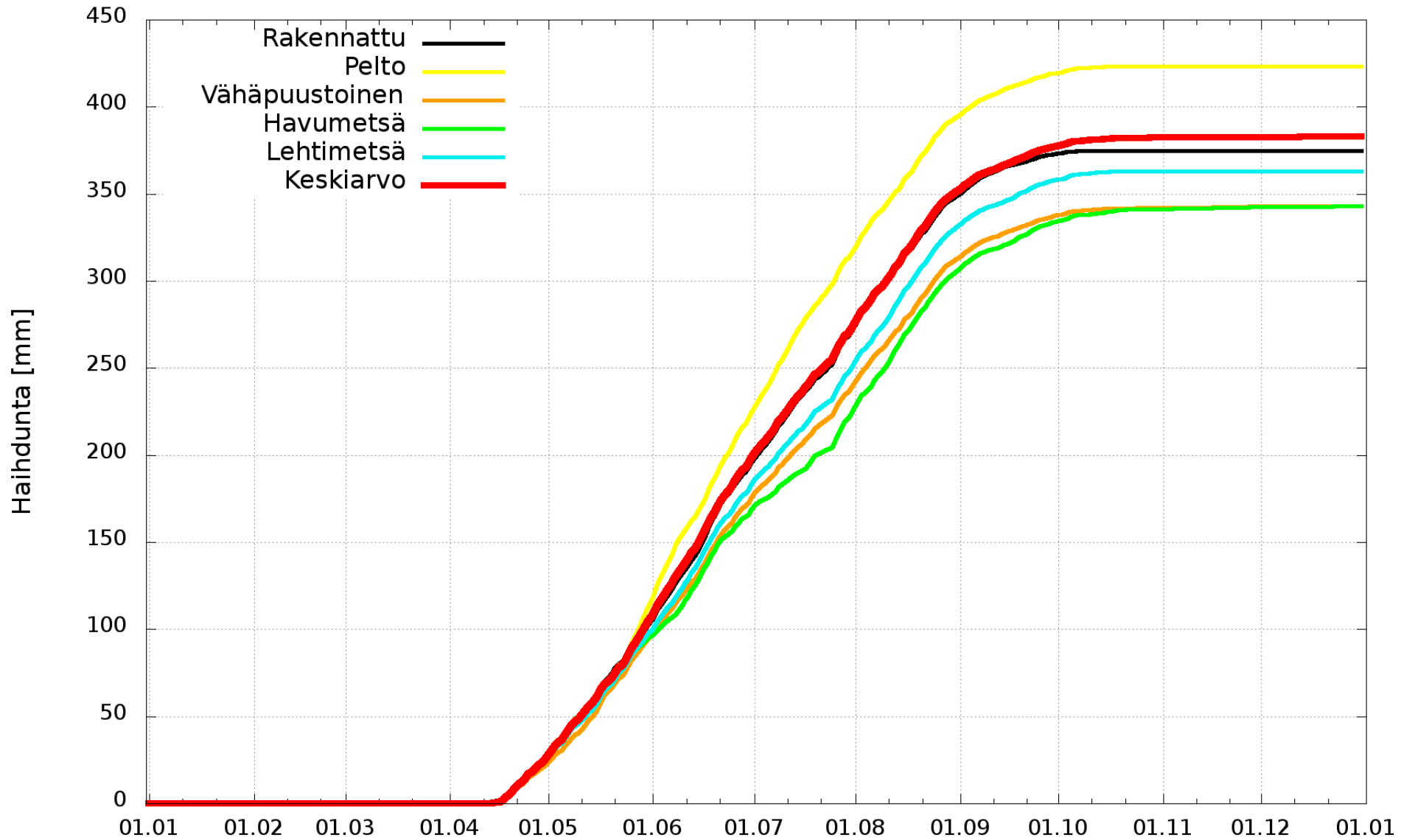

Malliversioiden vertailu operatiiviseen vesistömalliin

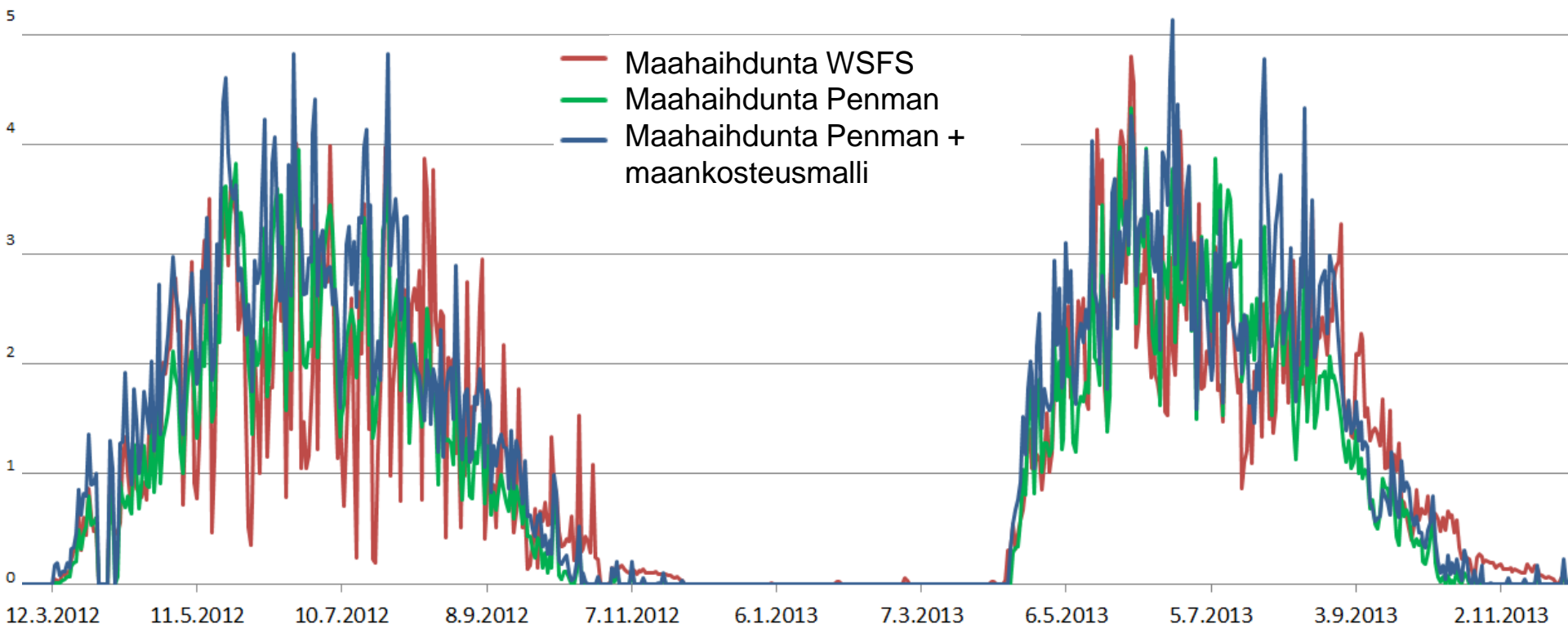

Ice thickness model

- Calculates ice thickness at observation points
 - All lake and river points in entire Finland
 - Simulates black ice, snow ice, slush and snow on ice
- Ice growth is driven by
 - Air temperature
 - Water temperature (beginning of freezing)
 - Thickness of snow and slush
 - Thickness of snow ice and black ice
- Melting of ice
 - Air temperature, snow

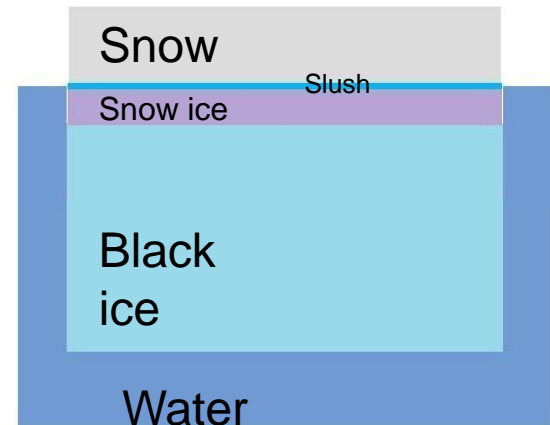

Ice thickness model

- Ice growth is calculated by using heat transfer
 - Stefan's equations
 - Snow ice and black ice separated
 - T_a = Air temperature, L = thermal capacity,
 - h_i , h_s ja h_{si} = height of black ice, snow ice and slush
 - ρ_{si} ja ρ_i = density of snow ice and black ice
 - k_i , k_s ja k_{si} = coefficient of heat transform
 - Indexes i , s ja si : black ice, snow and snow ice
- Sulaminen lasketaan astepäivätekijällä

$$\left\{ \begin{aligned} \frac{dh_{si}}{dt} &= \frac{-k_s T_a}{\left(h_s + \frac{k_s}{k_{si}} h_{sl}\right) \rho_{si} L} \\ \frac{dh_i}{dt} &= \frac{-k_i T_a}{\left(h_i + \frac{k_i}{k_s} h_s + \frac{k_i}{k_{si}} h_{si}\right) \rho_i L} \end{aligned} \right.$$

$$\left\{ \begin{aligned} h_{si}^{t+1} &= h_{si}^t - m_{si} T_a^t \\ h_i^{t+1} &= h_i^t - m_i T_a^t \end{aligned} \right.$$

Ice thickness model 4.2.2014

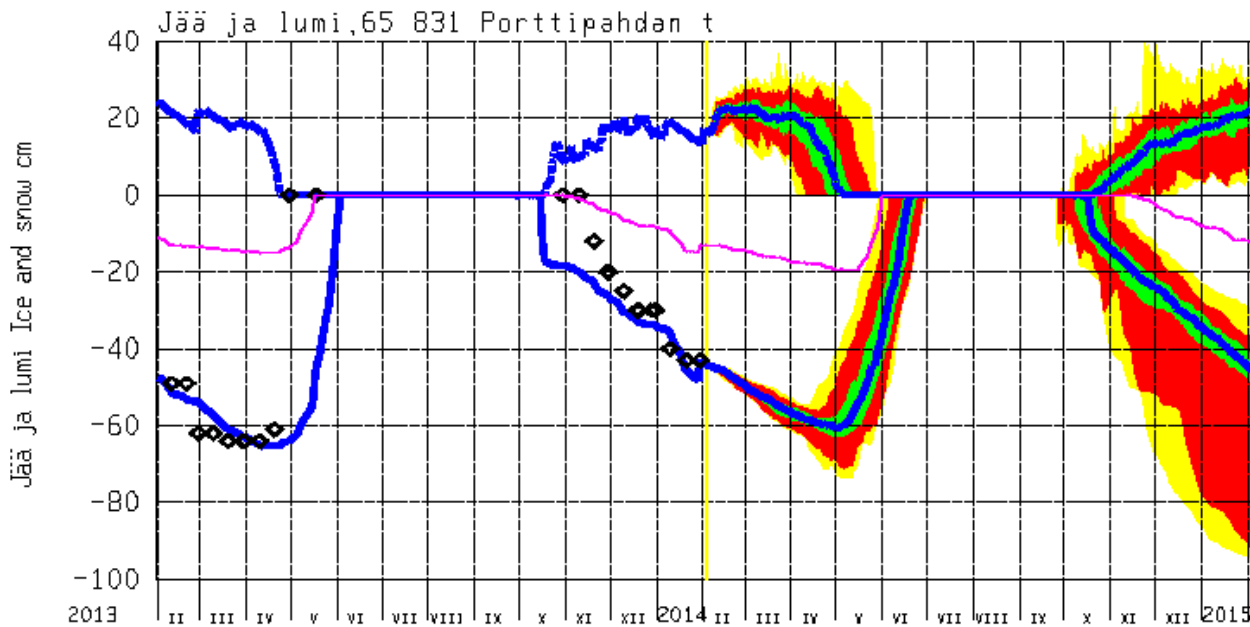

Observed (black diamond) and simulated total ice (solid blue line), snow ice (solid cyan line) and snow (dashed blue line above zero level)

Vesistömallijärjestelmä - SYKE-WSFS Watershed models

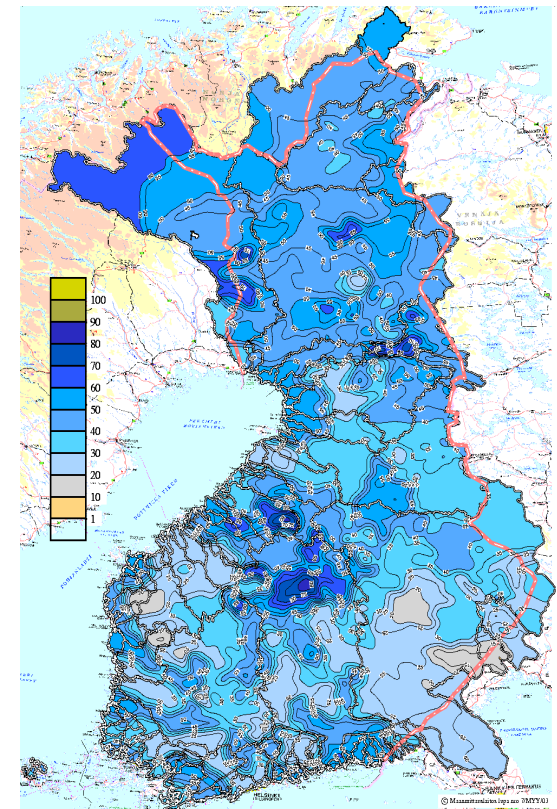

Forecasting ice jams

- Probability of ice jam formation under breakup
- Ice breakup probability for each day

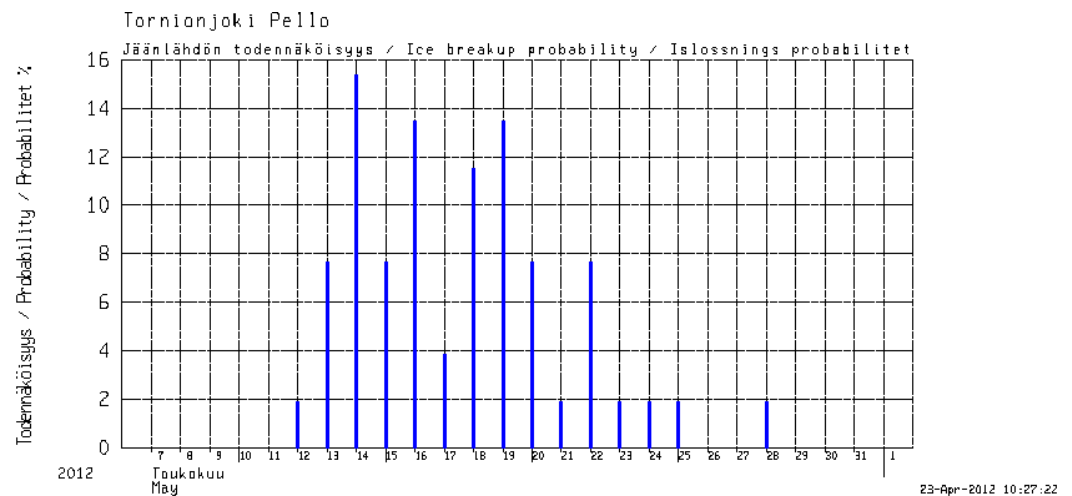
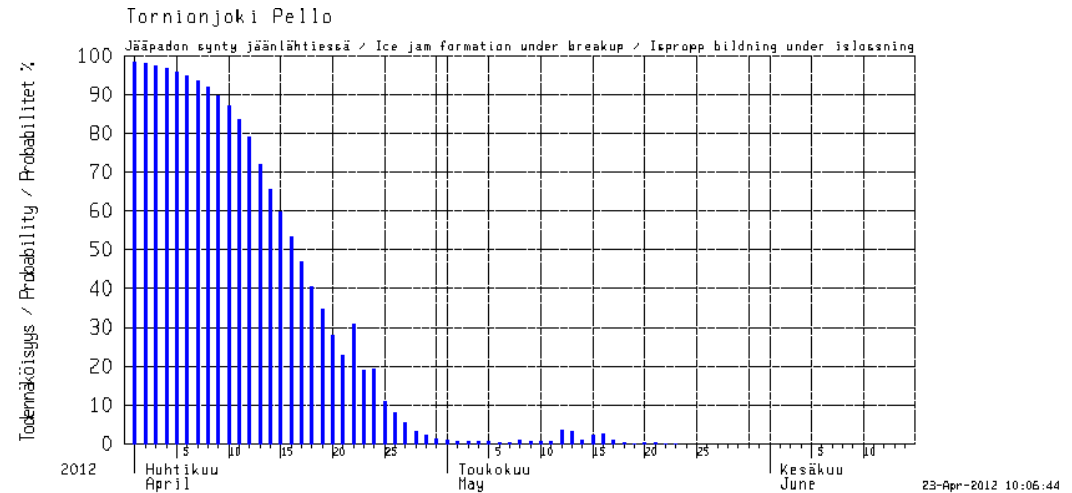

Forecasting ice jams

- Combining the previous results gives the ice jam probability for each day
- Ice jam forecasts are highly reliable few days ahead, after that the reliability decreases
- www.ymparisto.fi/vesistoennusteet -> Tornionjoki

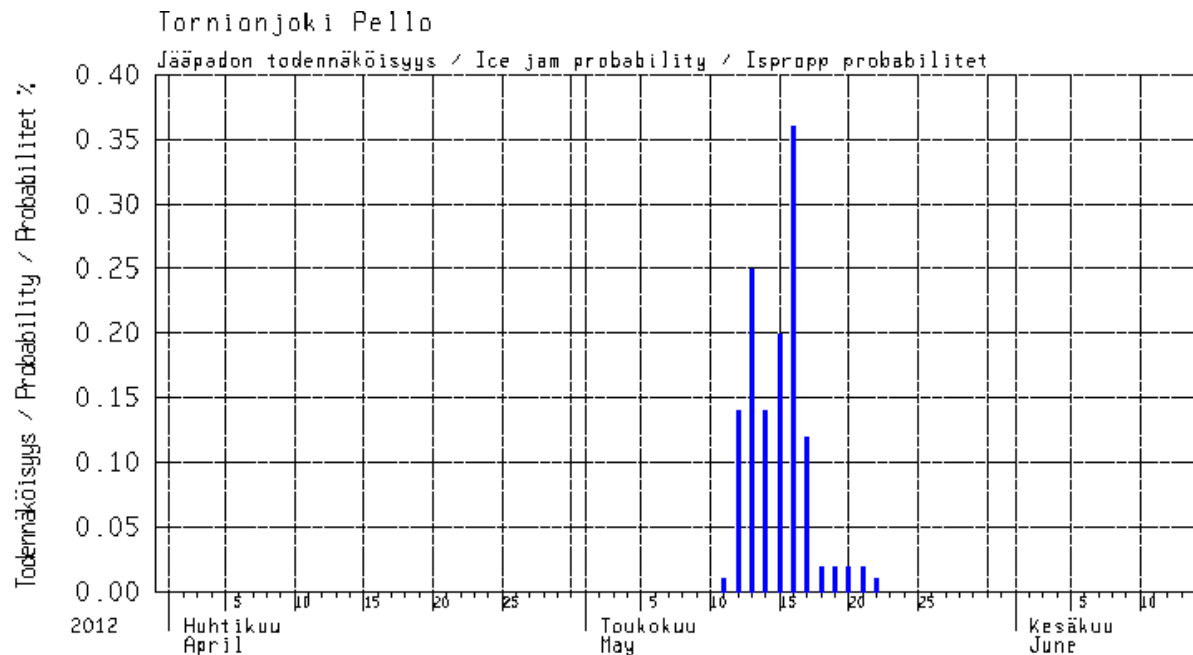

Frazil ice effect to water level model

- Discharge is normalized to average conditions
 - $Q_{\text{relat}} = Q / \text{station mean } Q * 350$
- 1 and 3 day average air temperature limits frazil ice growth
 - $T_{\text{frazil}} = 0.0087 * Q_{\text{relat}} - 13.913$ (1vrk)
 - $T_{3_mean_frazil} = 0.0174 * Q_{\text{relat}} - 13.826$ (3vrk)
- If 1 and 3 day air temperatures are below frazil ice growth limit temperatures, water level will increase meters per day
 - $\Delta H_{\text{frazil}} = (0.0001 * Q_{\text{relat}} - 0.0102) * (T_{\text{air}} + 10)$
- Frazil ice effect to the water level decrease if $T_{\text{air}} > -6.0$ C or T_{air} increases over 4 C per day
 - $\Delta H_{\text{frazil}} = -1 * (0.0009 * T_{\text{air}}^2 + 0.0281 * T_{\text{air}} + 0.2195)$

Forecasts provide predictions on hydrological phenomena for the needs of:

Hydropower industry



Operational lake regulation

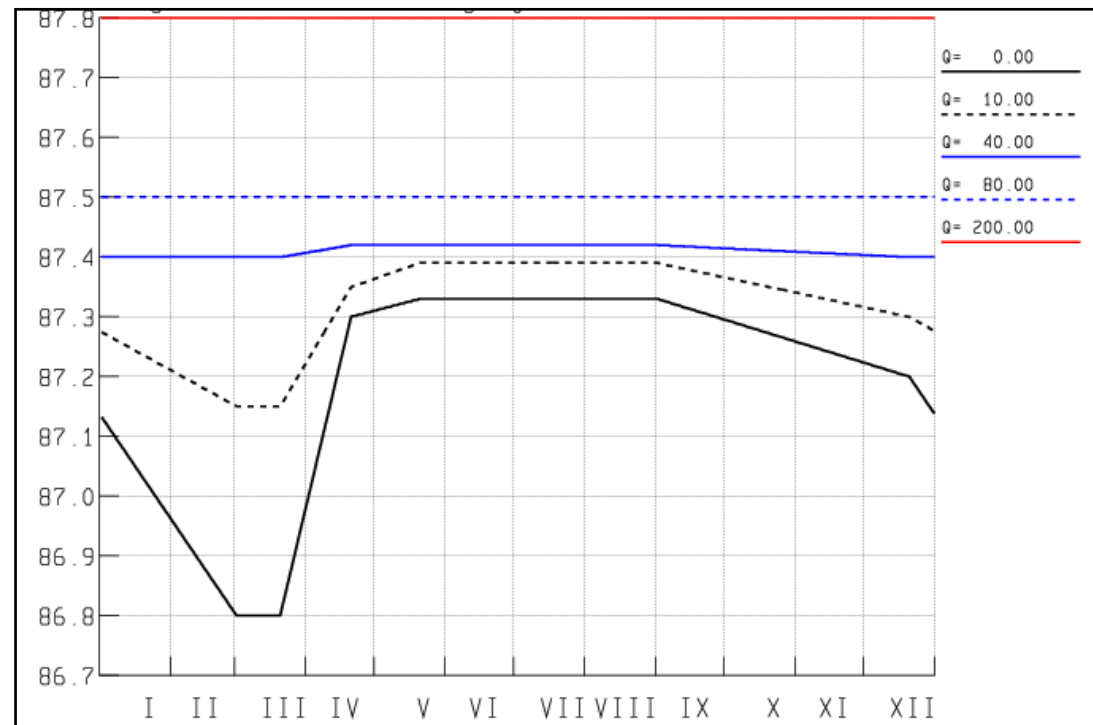

Hydropower companies save regulation plans into WSFS to get accurate forecasts

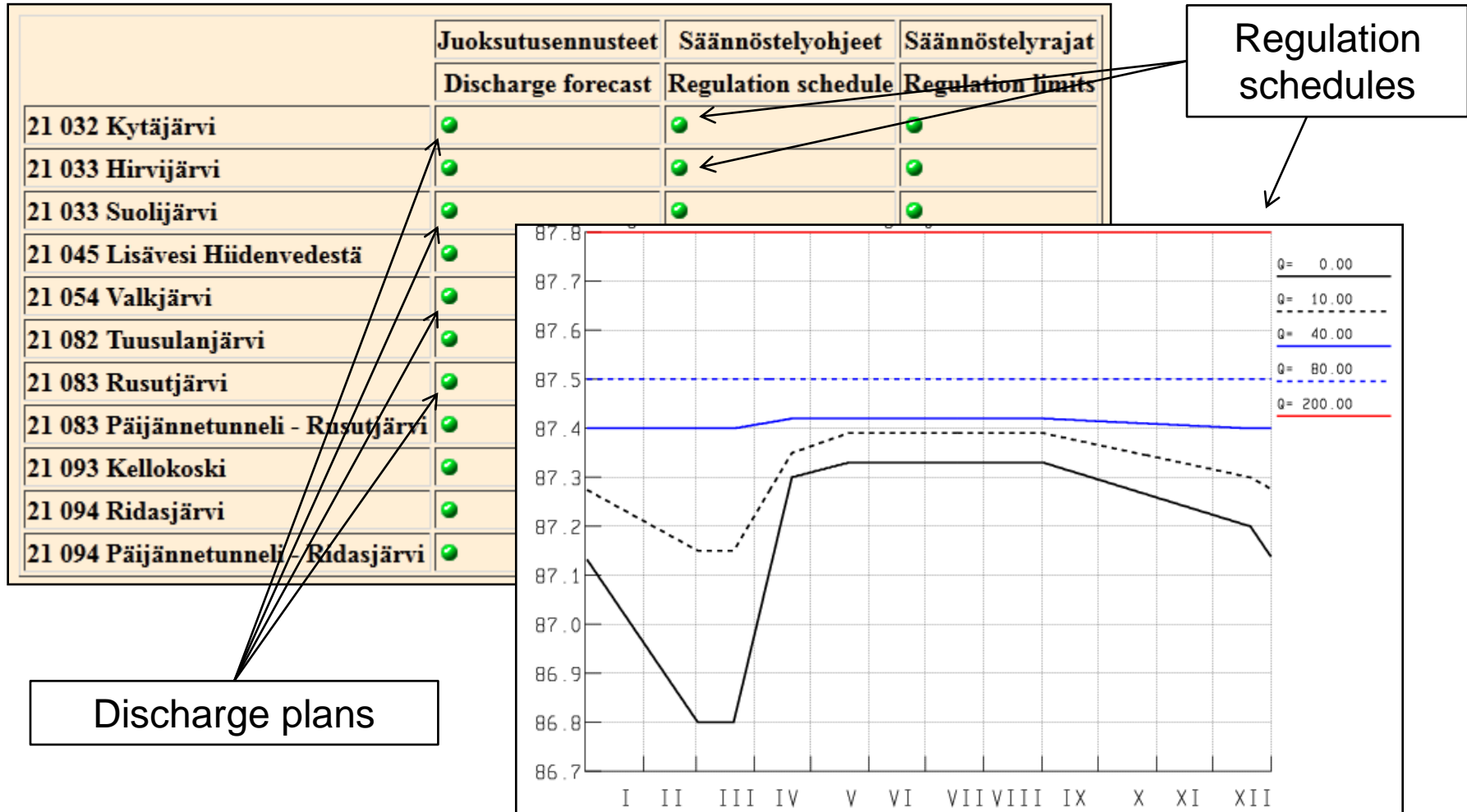

Reservoir Content for Finland

Reference values are from the period 1978-2006. 100 % reservoir capacity is 5530 GWh.

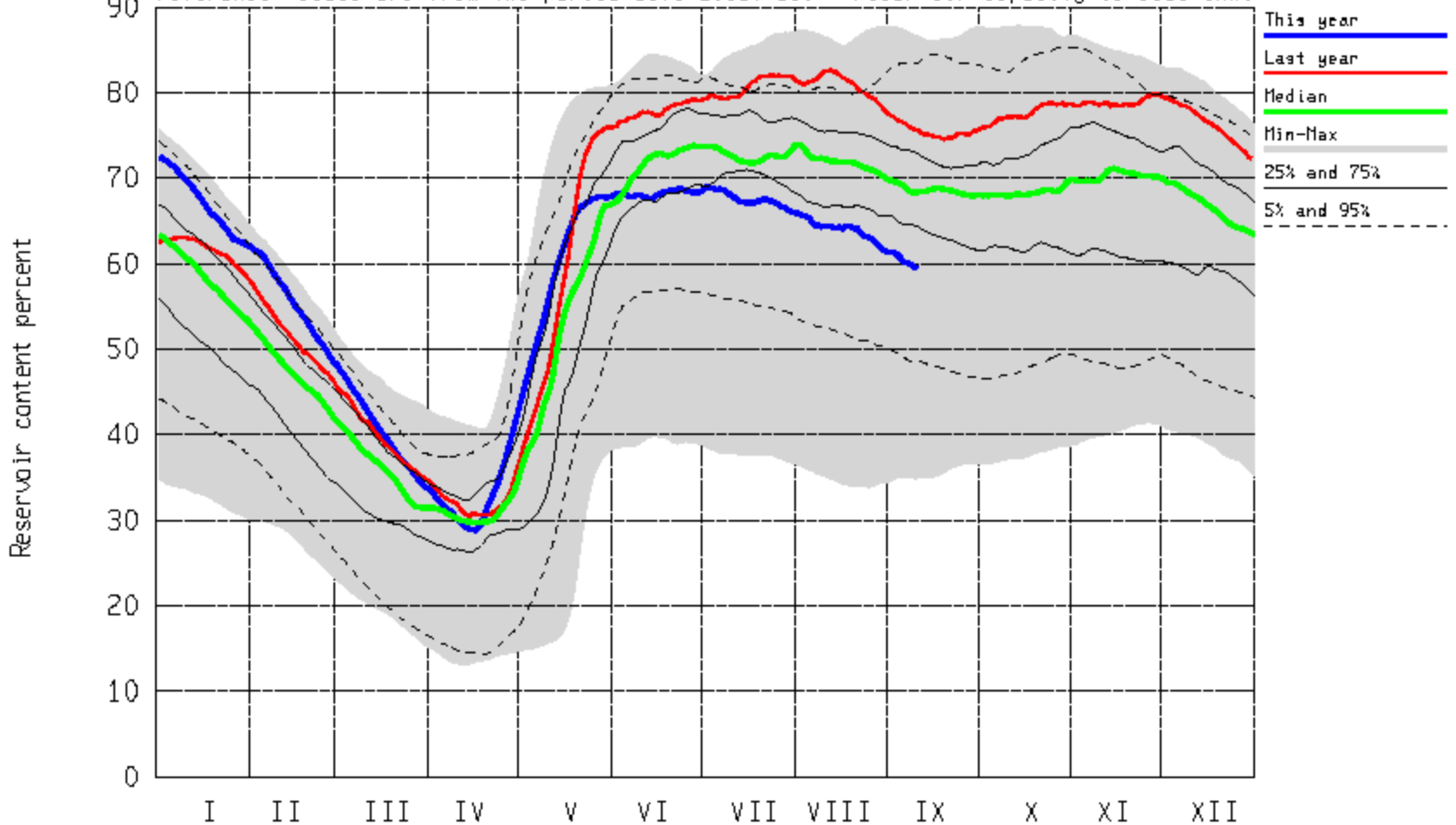

Internet, local media www-news

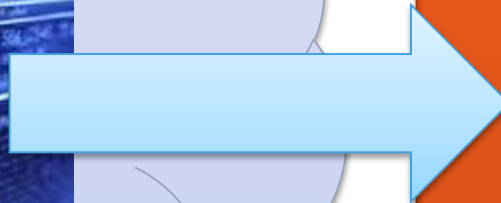

Flood Centre

Automatic
media
monitoring



Officers on duty (met. & hyd.)



Danger level	Description / impact / potential damages	Dissemination channels
Very dangerous flood	"Danger to human life and health"	<ul style="list-style-type: none"> • Danger alerts (interrupts radio and television broadcasts) • LUOVA (Natural disaster warning system) warnings • Automatic flood warnings from lakes and rivers • Water Situation Bulletin for authorities • FMI and SYKE www-pages • Mobile application • LUOVA notices • Television weather news (YLE) • Media • Twitter
Dangerous flood	"Damages to buildings"	
Flood	"Anything which differs flood-wise from normal casual everyday life"	

National water situation online:

<http://www.ymparisto.fi/vesitilanne> (in Finnish)

- Edited, up-to-date information about water situation in Finland
- Flood information during floods
- Written hydrological forecasts for basins
- Overall and detailed versions

6.12.2015

Joet tulvakorkeuksissa Etelä- ja Keski-Pohjanmaalla sekä Lounais-Suomessa (Tulvakeskus 6.12.)

Länsirannikon jokien vedenpinnat ovat paikoin tulvakorkeuksissa sateisen ja lauhan sään johdosta. Lapväärtinjoella, Teuvanjoella, Närpiönjoella ja Maalahdenjoella vesi on noussut tulvakorkeuteen. Vesi on noussut pelloille Loimijoella ja Lapuanjoen Liinamaassa. Tälle päivälle ennustetut sateet kasvattavat jokien virtaamia vielä paikoin Etelä- ja Keski-Pohjanmaalla ja Lounais-Suomessa. Sateiden vaikutukset ulottuvat myös Etelä- ja Itä-Suomen vesistöihin nostaten jokien vedenkorkeuksia. Vesi nousee jokiuomissa paikoin vastaamaan keskimääräistä tulvaa Etelä- ja Keski-Pohjanmaalla sekä Lounais-Suomessa. [Lisää](#)

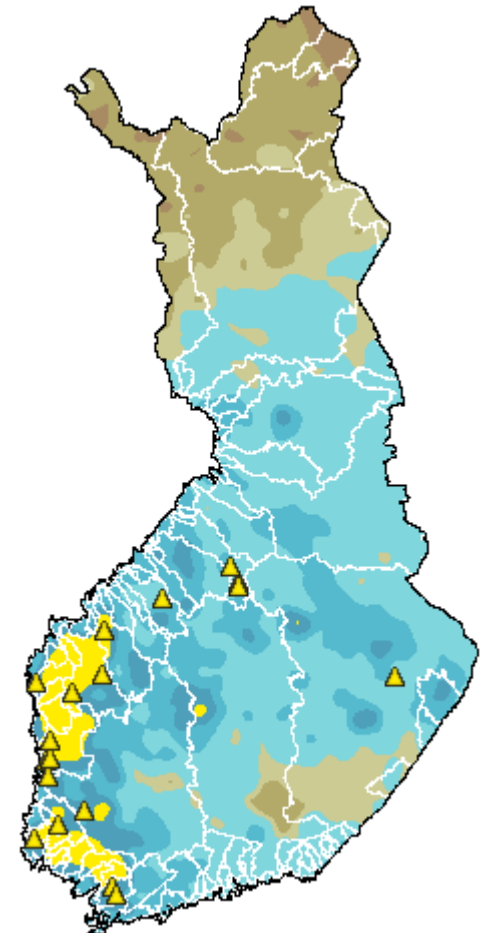
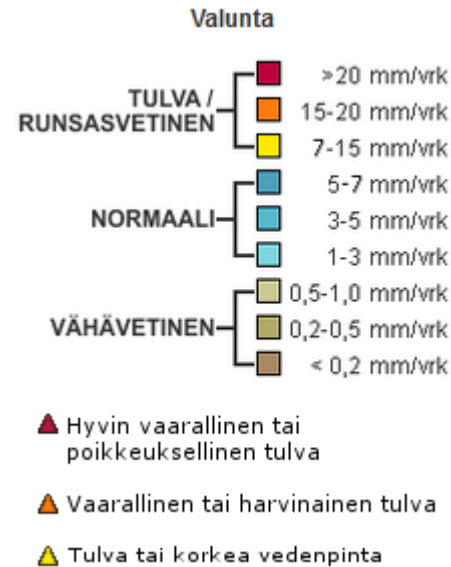

SYKEN hydrologit uudelleentwiittasi

ELY Tulvatpohjanmaa @tulvatpohjanmaa · 14 t

#Närpiönjoki 'en virtaaman nousu näyttää tasaantuneen tasolle 107 m3/s ja aurinko paistaa joen alaosalla #elykeskus

Water Situation Bulletin for authorities 7.2.2014

Tulvakeskuksen vesitilanne ja ennuste 7.- 12.2.2014

Laadittu 7.2.2014

LAATIJAT

Tulvapäivystäjä Juho Jakkila

LUOVA-päivystäjä Helena Laakso/Paavo Korpela

Meripäivystäjä -

VAARATASOJEN TODENNÄKÖISYYDET

[0%] Hyvin vaarallinen tulva

[0%] Vaarallinen tulva

[5%] Tulva

[95%] Ei tulvaa

VESISTÖJEN TILANNE TIIVISTETYSTI

Viikonloppuna lauhtuva sää ja vesisateet lisäävät valuntaa ja rannikkoalueiden pienten jokien virtaamia Etelä- ja Lounais-Suomessa. Rannikkoalueiden lumimäärät ja viikonlopuksi ennustetut sateet eivät kuitenkaan nosta jokien vedenkorkeuksia tulvalukemiin. Mikäli sää jatkuu leutona ja sateisena voi tilanne muuttua ensi viikon aikana.

ARVIOT VAHINGOISTA

Todennäköisesti ei uusia vahinkoja.

EPÄVARMUUSTEKIJÖITÄ

Lauhtuva keli saattaa irrottaa jokien suppokasaumia ja synnyttää uusia jääpatoja, mikä voi aiheuttaa paikallista tulvimista. Tämä ei kuitenkaan ole kovin todennäköistä.

SÄÄ- ja RANKKASADETILANNE TIIVISTETYSTI

Suomessa vallitsee viikonloppun ajan lauha etelänpuoleinen ilmavirtaus. Lauantaina lumisadealue liikkuu Suomen yli. Lounaassa sataa myös räntää, ehkä vettäkin. Sadetta kertyy vedeksi muutettuna 2-10 mm, Pohjois-Lapissa 0-2 mm. Sunnuntaina alkuviikolla tulee paikoin vähäisiä lumitai jäätäviä tihkusateita.

MERIVESITILANNE TIIVISTETYSTI

Ennustejakson aikana ei ole odotettavissa merivesitulvia.

Water Situation Bulletin for authorities 29.11.2015

Tulvakeskuksen vesitilanne viranomaisille
29.11. - 1.12.2015

LAATIJAT

Tulvapäivystäjä Tiia Vento

Meripäivystäjä -

Luova-päivystäjä Hannu Valta

LAATIJAT

Tulvapäivystäjä Tiia Vento

VAARATASOJEN TODENNÄKÖISYYDET

Vesistötulvat:

[0 %] Hyvin vaarallinen tulva

[2 %] Vaarallinen tulva

[78 %] Tulva: Pohjanmaa, Etelä-Pohjanmaa

[20 %] Ei tulvaa

VESISTÖJEN TILANNE TIIVISTETYSTI

Sateinen ja lauha sää on kasvattanut virtaamia etenkin Pohjanmaan alueella tällä viikolla. Vaasan eteläpuolisissa pienissä vesistöissä jokien pinnat ovat nousseet korkealle yön ja aamun aikana. Matalapaine tuo lisää sateita Pohjanmaan alueelle ja sadekertymä lähipäiville on ennusteen mukaan 20-30 mm. Jos sateet tulevat vetenä ne nostavat virtaamia nopeasti sillä maaperä on märkää. Vesi voi nousta alaville pelloille ja myös tulviminen paikallisteille on mahdollista.

MERIVESITILANNE TIIVISTETYSTI

Tuulista johtuen merenpinta on viikonvaihteessa paikoin korkealla eritoten Saaristomerellä ja Pohjanlandella.

RANKKASADETILANNE TIIVISTETYSTI

Rankkasateiden todennäköisyys on vähäinen.

Water situation maps in television broadcast with weather forecast

ohjelmat Suorat Sarjat ja elokuvat Viihde ja kulttuuri Dokumentit ja fakta Uutiset Urheilu Lapset

yle

4.11. JOKIEN VESITILANNE
lähde: Tulvakeskus

tulva / runsasvetinen

normaali

vähävetinen

usteita 6 h jäljellä Lisää samankaltaista

Natural disaster warning system LUOVA

- Closed warning and situation picture system for security authorities and state management
- Joint service of Meteorological Institute (FMI, main operator of LUOVA), Environmental Institute (SYKE) and Seismology Institute (HY)
- Warning messages with SMS and email, "whole story" at web-portal
- IL LUOVA-officer on duty monitors national situation 24/7 (in flood situations also hydrologist and/or marine expert 24/7)



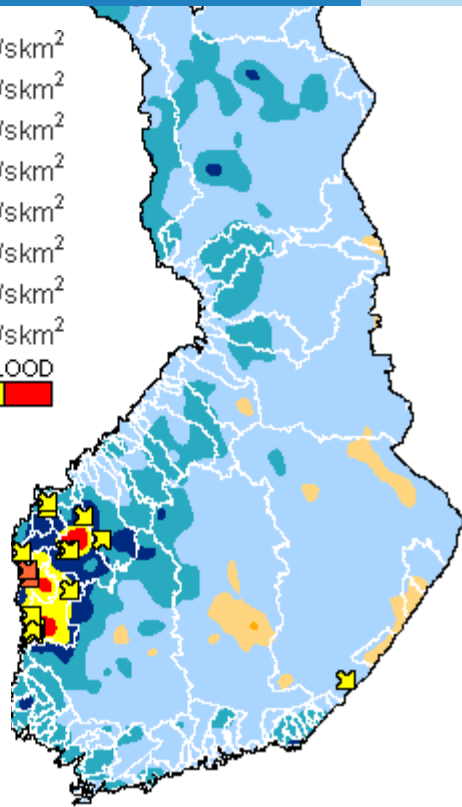
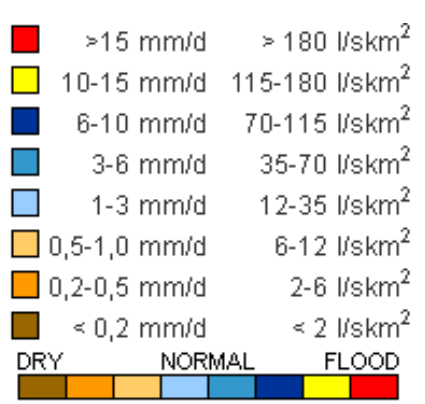

Summary:
Flood threat at river Kyrönjoki

Area of danger:
South Ostrobothnia, Kyrönjoki

Time of danger:
6.10.2012-13.10.2012

Flood situation and forecast
Water level at Nikkola has risen above flooding level N43+40.00m today at 11AM. Flood gates have been opened to prevent further damage by running water to fields. Water level is forecasted to ...

Weather situation and forecast:
Today will rain water in general 10-15mm, and...

Possible damages and human influences:
100 hectare of fields under flood, residents of Tuomikylä, Ilmajoki are blocked by flood

Critical infrastucture on area:

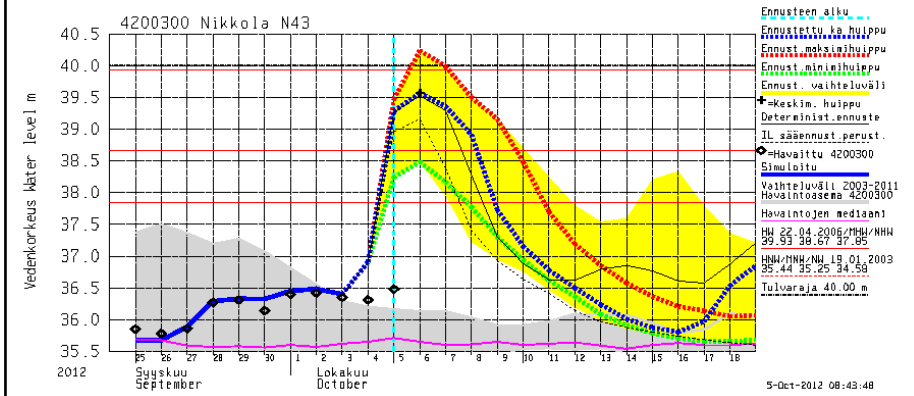
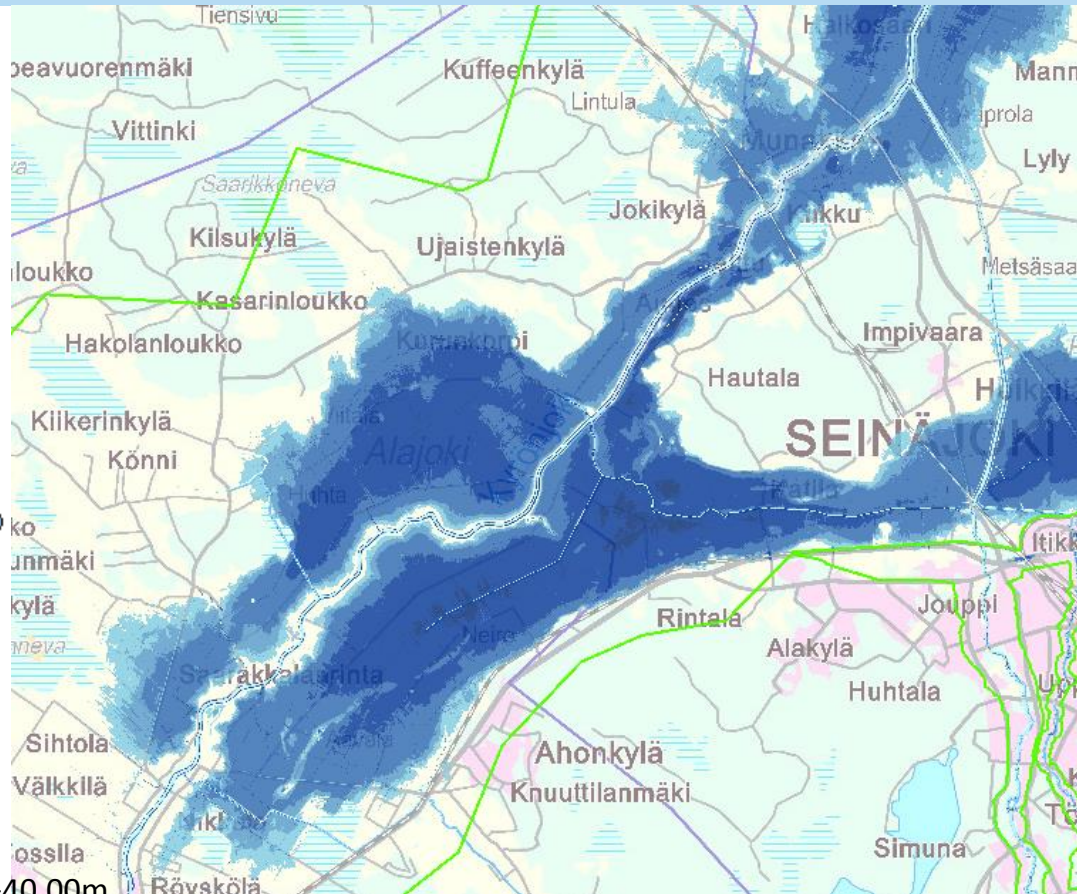

LUOVA

LUONNONONNETTOMUUKSIEN
VAROITUSJÄRJESTELMÄ

[Yhteydenotot](#) | [Linkit](#) | [Palaute](#) | [LUOVA](#) | [Kirjaudu ulos](#)

Vaaratasot: Ei vaaraa ■ Mahdollisesti vaarallinen ■ Vaarallinen ■ Hyvin vaarallinen ■

[Varoitukset nyt](#)

[Tietoja ilmiöistä](#)

[Tietoja varoituksista](#)

[Arkisto](#)

Tilannekuva

- » Myrskyt
- » Hirmumyrskyt
- » Ukkoset
- » Rankkasadetulvat
- » Lumisateet
- » Metsäpalot
- » Vesistötulvat
- » Meriveden korkeus
- » Maanjäristykset
- » Tsunamit
- » Tulivuoren purkaukset
- » Aurinkomyrskyt
- » Muut ilmiöt

Vaarataso: Mahdollisesti vaarallinen ■

Vesistötulva

Pohjois- ja Keski-Pohjanmaa, Kymijoen ja Vuoksen vesistöalueet, Häme, Kainuu



24.1.2014 21:17

Yhteenveto:

Hyydetulvatilanne jatkuu - asuinrakennuksia vaarassa

Vaara-alue:

Pohjois- ja Keski-Pohjanmaa, Kymijoen ja Vuoksen vesistöalueet, Häme, Kainuu

Vaara-aika:

24.-31.1.2014

Tulvatilanne ja -ennuste:

Hyydetulvatilanne jatkuu monin paikoin lähes koko maassa Lappia lukuun ottamatta, kunnes kovat pakkaset

